

District Department of Transportation
Transportation Operations Administration
Top Level Organization Chart

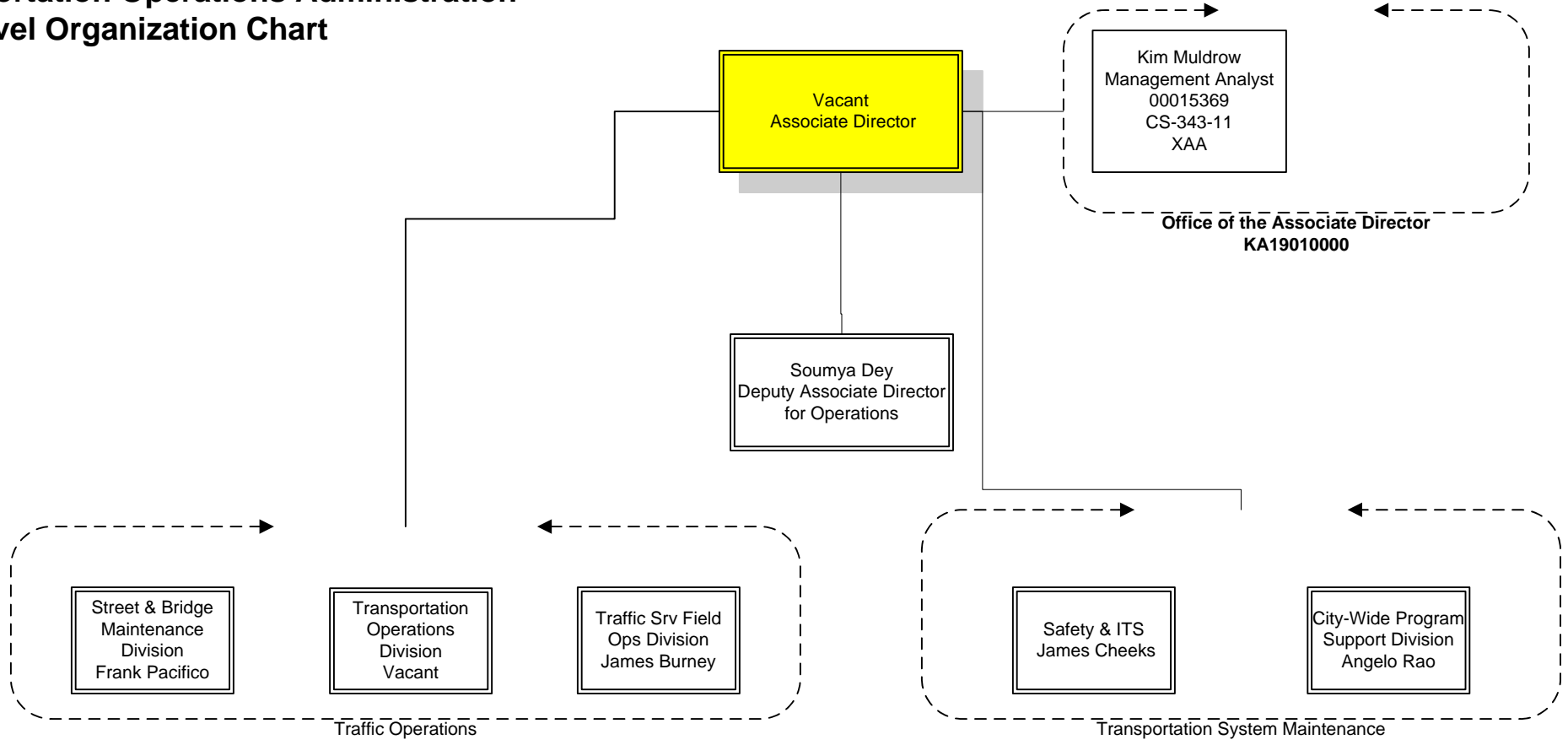

District Department Of Transportation

Transportation Operations Administration

City-Wide Program Support Division

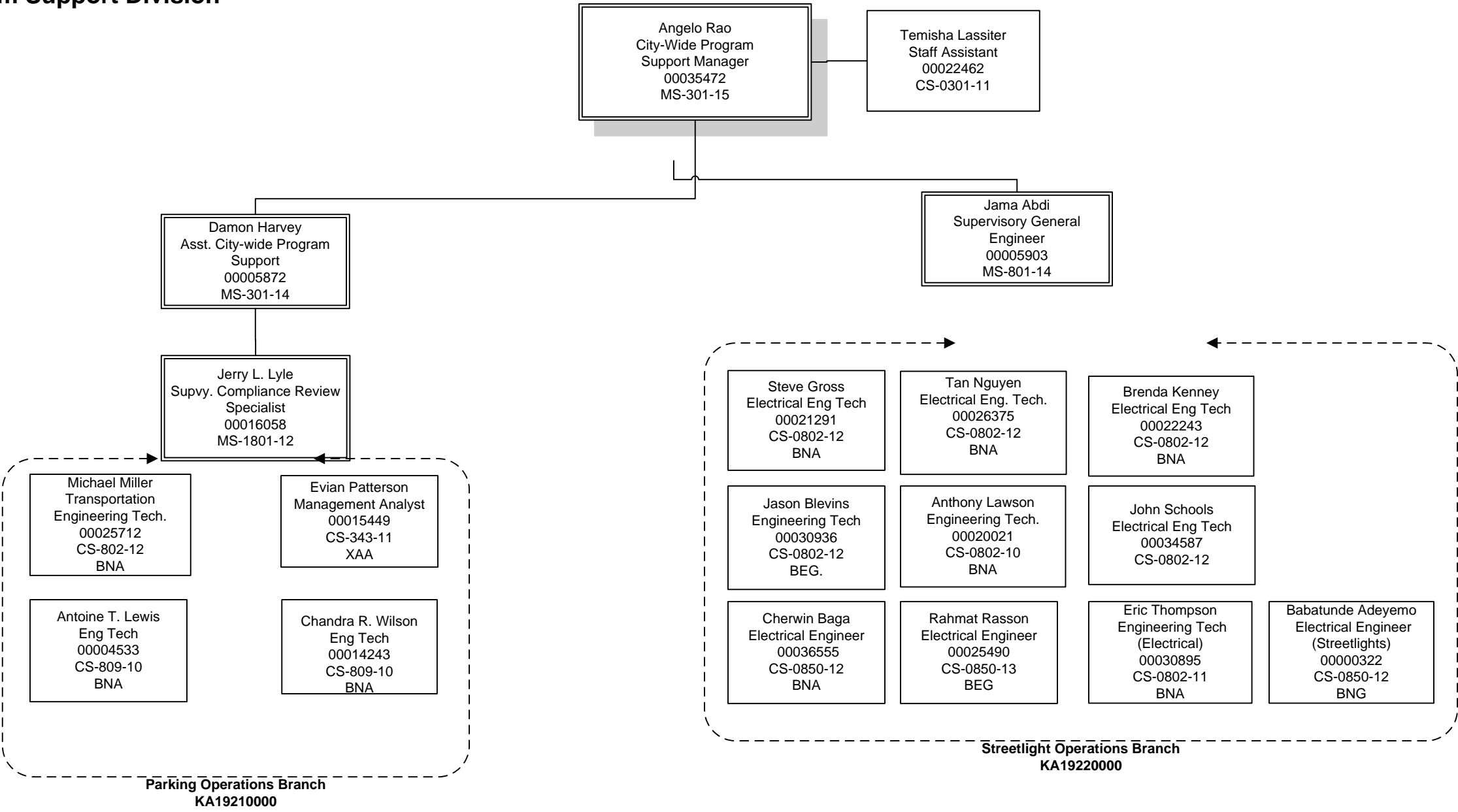

District Department Of Transportation

Transportation Operations Administration

Safety & Standards Division

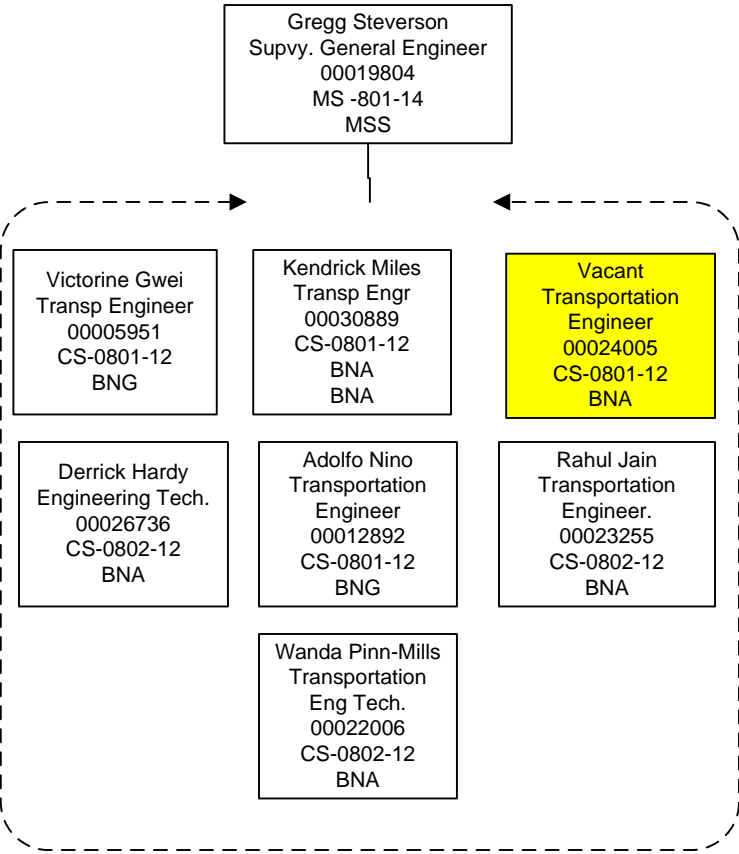

Transportation Safety Engineering

District Department Of Transportation

Transportation Operations Administration

Intelligent Transportation Systems Division

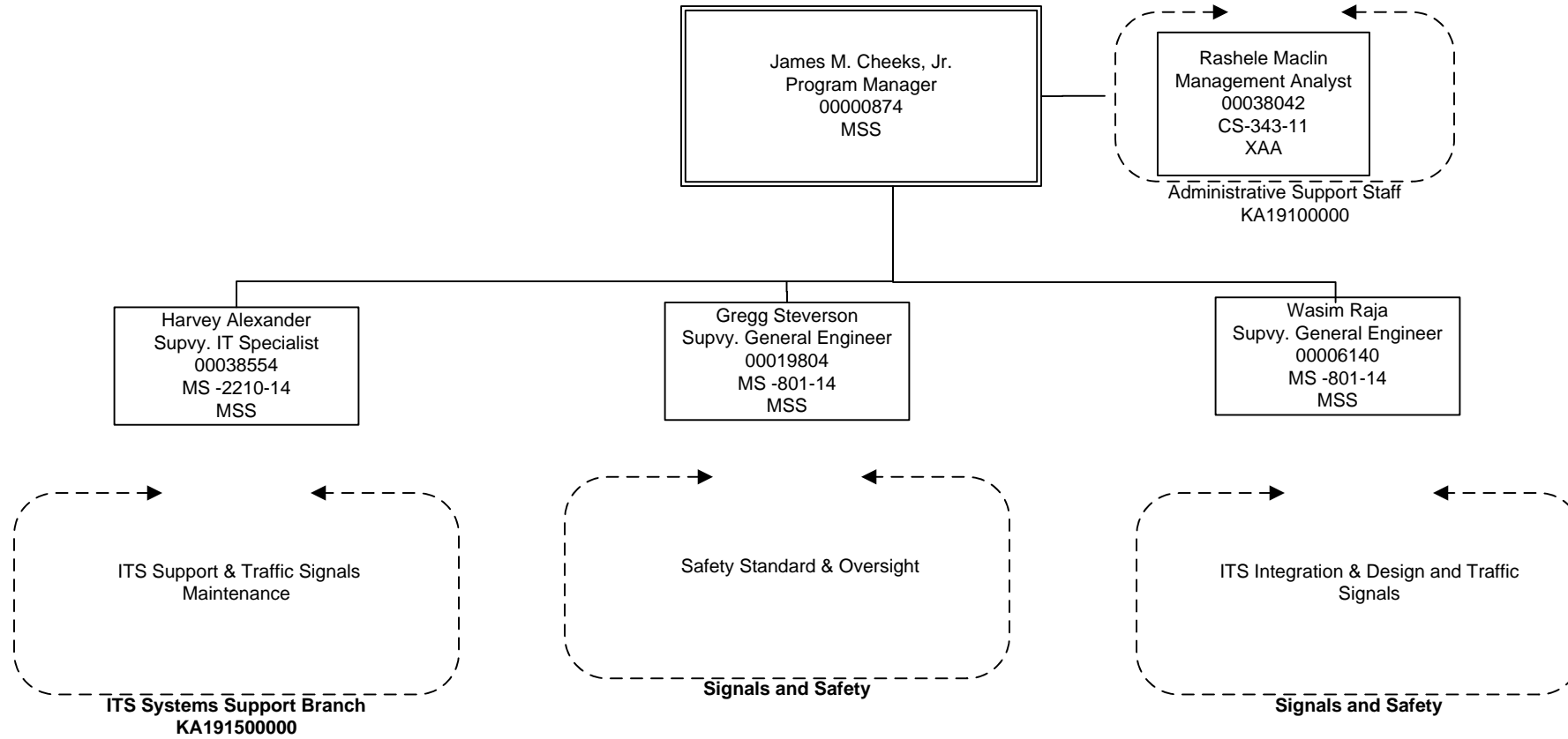

District Department Of Transportation

Transportation Operations Administration
 Intelligent Transportation Systems
 ITS - Support

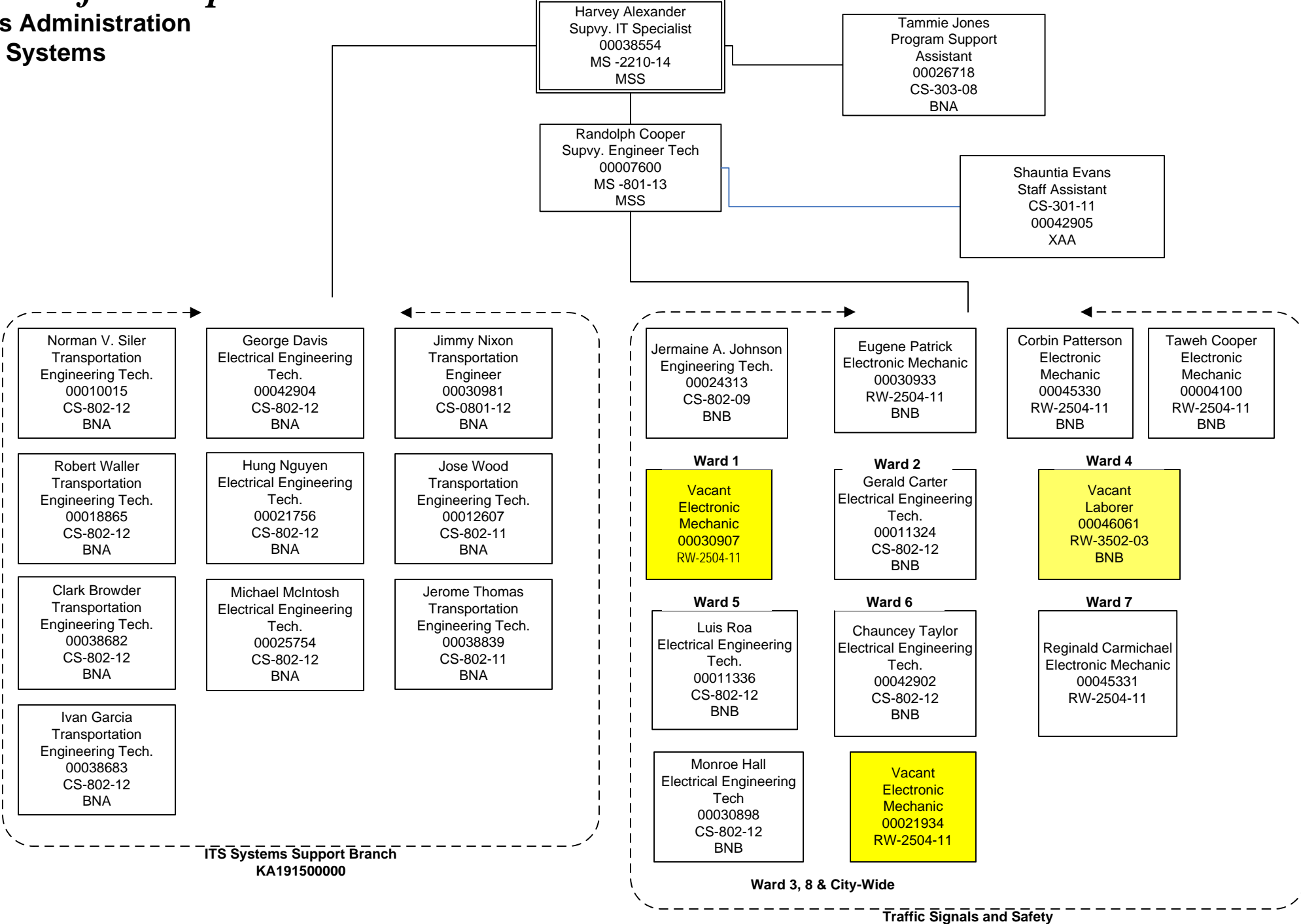

District Department Of Transportation

Transportation Operations Administration

Intelligent Transportation Systems

Signals & Safety Team

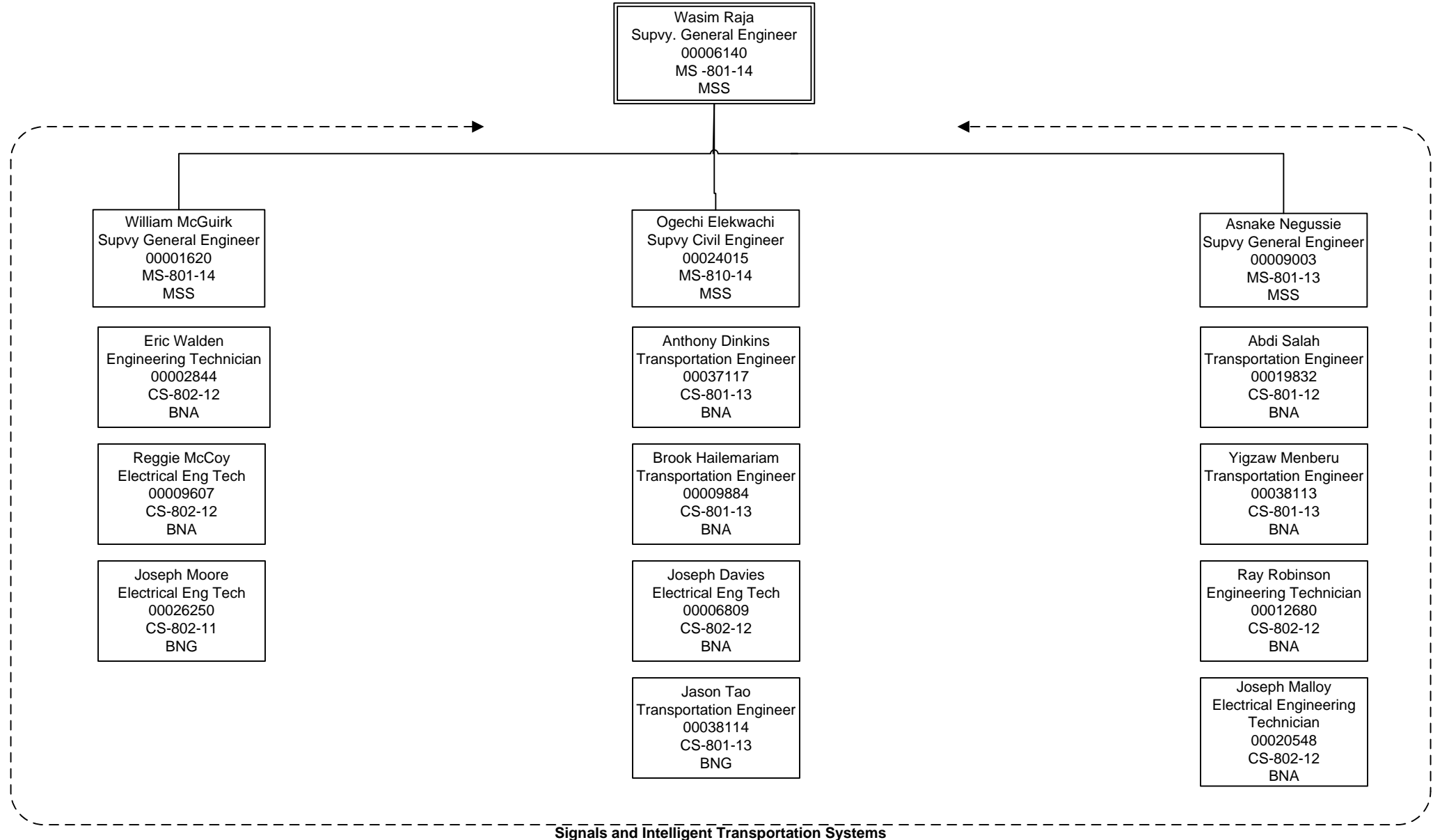

Signals and Intelligent Transportation Systems

District Department of Transportation

Transportation Operations Administration Transportation Operations Division

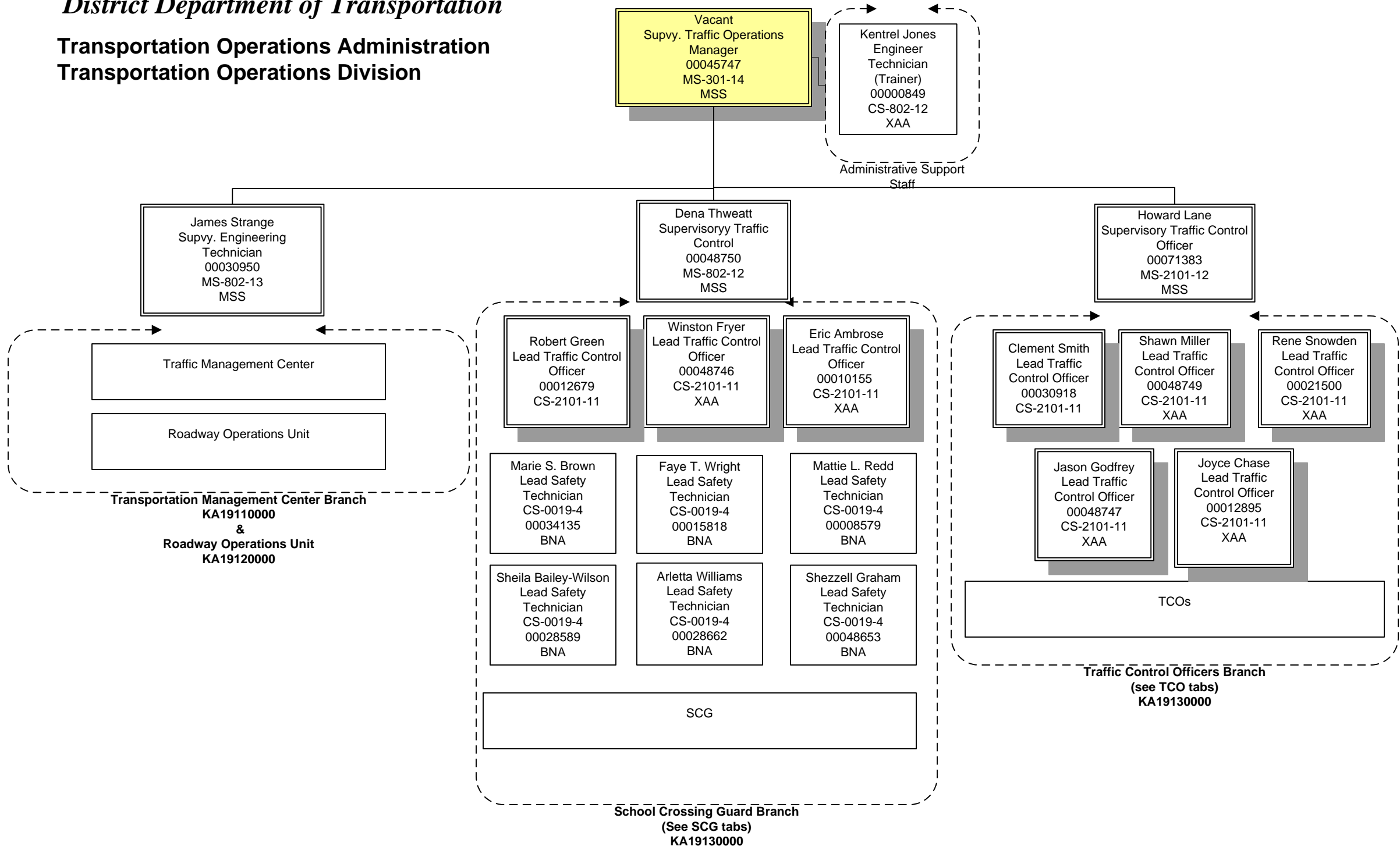

District Department of Transportation
Transportation Operations Administration
Transportation Operations Division
Traffic Management Center

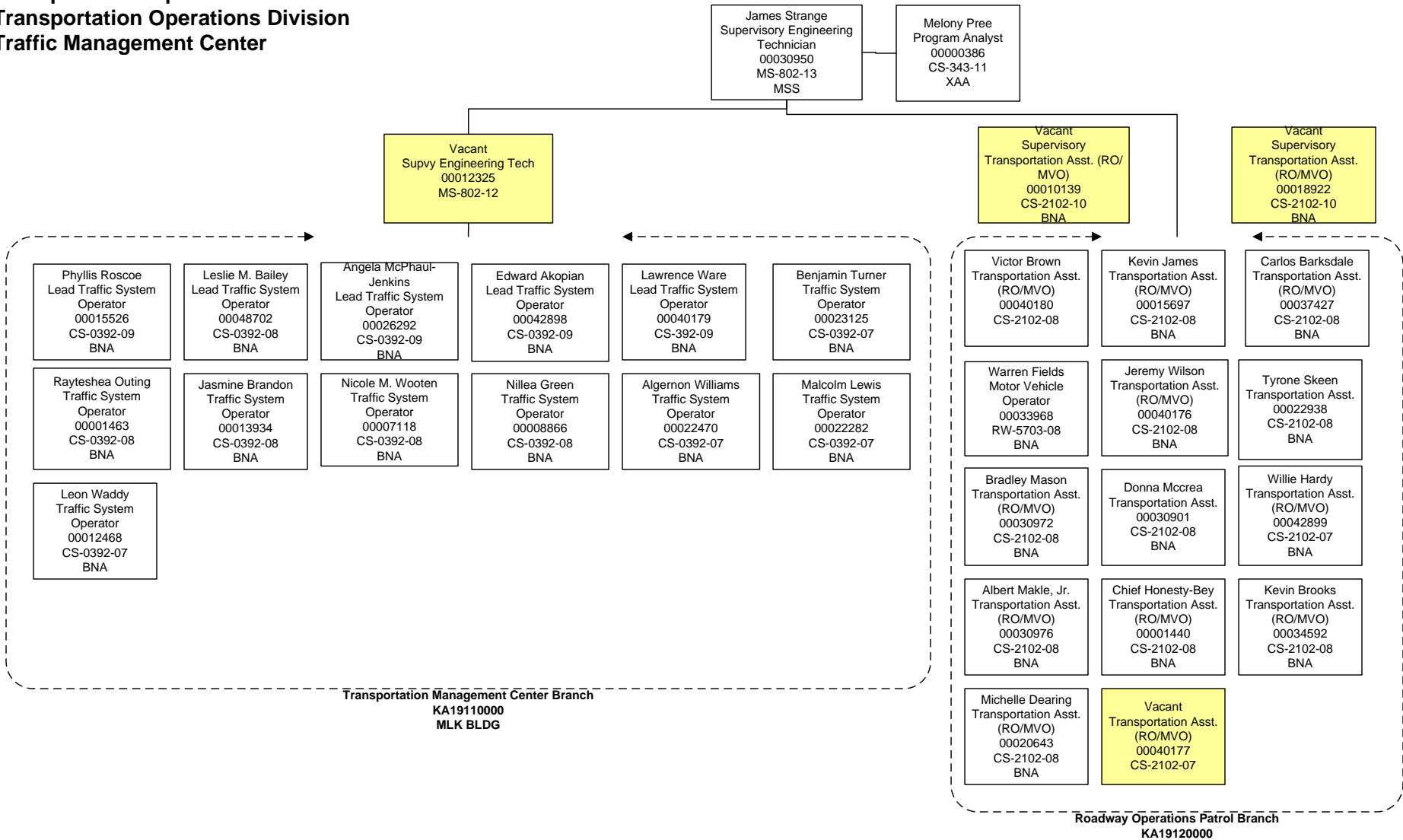

District Department Of Transportation

Transportation Operations Administration Transportation Operations Division Traffic Control Officer Program

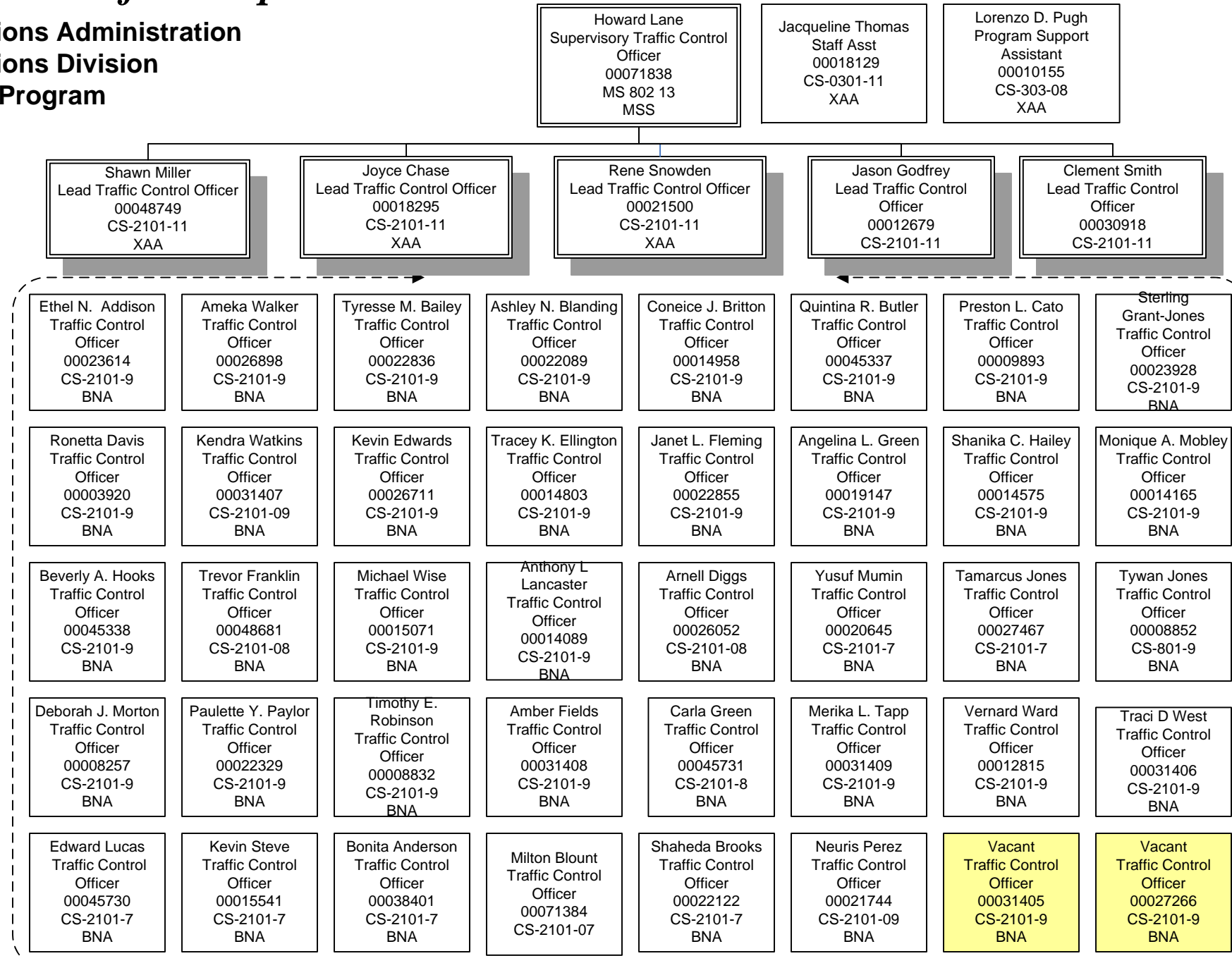

District Department Of Transportation

Transportation Operations Administration

Transportation Operations Division

Traffic Control Officer Program

Shawn Miller
Lead Traffic Control Officer
00048749
CS-2101-11
XAA

Joyce Chase
Lead Traffic Control Officer
00018295
CS-2101-11
XAA

Rene Snowden
Lead Traffic Control Officer
00021500
CS-2101-11
XAA

Jason Godfrey
Lead Traffic Control Officer
00012679
CS-2101-11

Clement Smith
Lead Traffic Control Officer
00030918
CS-2101-11

Bianca Smith
Traffic Control Officer
00018452
CS-2101-07
BNA

Tanesha McNeil
Traffic Control Officer
00023051
CS-2101-09
BNA

Comontae Middleton
Traffic Control Officer
00045724
CS-2101-07
BNA

George Kollie
Traffic Control Officer
00017917
CS-2101-09
BNA

Lawrence Weaver
Traffic Control Officer
00028676
CS-2101-09
BNA

Charles Stanton
Traffic Control Officer
00009368
CS-2101-09
BNA

Lucia Roa
Traffic Control Officer
00045726
CS-2101-07
BNA

John Lewis
Traffic Control Officer
00045729
CS-2101-08
BNA

Roman Williams
Traffic Control Officer
00045732
CS-2101-09
BNA

LaCresha Bailey
Traffic Control Officer
00045727
CS-2101-07
BNA

Cierra Craig
Traffic Control Officer
00045723
CS-2101-09
BNA

Dimitri Dyson
Traffic Control Officer
00015556
CS-2101-07
BNA

Courtney Halsey
Traffic Control Officer
00017155
CS-2101-07
BNA

Sarah Butler
Traffic Control Officer
CS-2101-07
00021663
BNA

Kemeisha Butler
Traffic Control Officer
00022189
CS-2101-09

Geneva Ellis-Branch
Traffic Control Officer
00048678
CS-2101-09
BNA

Melvin Ray, Jr.
Traffic Control Officer
00025287
CS-2101-09
BNA

Alvin Durham
Traffic Control Officer
00045728
CS-2101-09
BNA

Devon Moon
Traffic Control Officer
00028610
CS-2101-09
BNA

Anthony Mattox
Traffic Control Officer
00003741
CS-2101-07
BNA

Dana Simpkins
Traffic Control Officer
00048671
CS-2101-09
BNA

LaJuan Simpson
Traffic Control Officer
00048679
CS-2101-09
BNA

Kenita Morgan
Traffic Control Officer
00048682
CS-2101-07
BNA

Yetta Gray
Traffic Control Officer
00007292
CS-2101-07
BNA

Gail Russell
Traffic Control Officer
00001996
CS-2101-07
BNA

Ruqayya Davis
Traffic Control Officer
00045761
CS-2101-07
BNA

Darnel Tillman
Traffic Control Officer
00002074
CS-2101-07
BNA

Joel Price
Traffic Control Officer
00008910
CS-2101-07
BNA

Wanda Beeks
Traffic Control Officer
00038019
CS-2101-07
BNA

Ikea Hudson
Traffic Control Officer
00046780
CS-2101-07
BNA

Arpell Haggins
Traffic Control Officer
00026469
CS-2101-07
BNA

Darlene Reeder
Traffic Control Officer
00025820
CS-2101-07
BNA

Ronnie Laster
Traffic Control Officer
00030896
CS-2101-07
BNA

Glen Walker
Traffic Control Officer
00027055
CS-2101-07
BNA

Michael Hall
Traffic Control Officer
00025018
CS-2101-07
BNA

LaQuanta Graham
Traffic Control Officer
00005456
CS-2101-07
BNA

Millicent Harris
Traffic Control Officer
00012601
CS-2101-07
BNA

Nettina Wren
Traffic Control Officer
00030915
CS-2101-07
BNA

I'vah Dennis
Traffic Control Officer
00037341
CS-2101-07
BNA

Wendy McMillan
Traffic Control Officer
00025134
CS-2101-07
BNA

Cheryl Summers
Traffic Control Officer
00012634
CS-2101-07
BNA

Pamela A Johnson
Traffic Control Officer
00006303
CS-2101-07
BNA

Marcus Graham
Traffic Control Officer
00006910
CS-2101-09
BNA

Sharon Franks-Dunbar
Traffic Control Officer
00009929
CS-2101-07
BNA

Ramona Boardley
Traffic Control Officer
00014075
CS-2101-07
BNA

Jenita Johnson
Traffic Control Officer
00021602
CS-2101-07
BNA

George Brice
Traffic Control Officer
00048674
CS-2101-07
BNA

Gina Porter
Traffic Control Officer
00021881
CS-2101-07
BNA

Marcus Johnson
Traffic Control Officer
00025514
CS-2101-09
BNA

District Department Of Transportation

Traffic Services Administration
 Transportation Operations Division
 School Crossing Guard Program

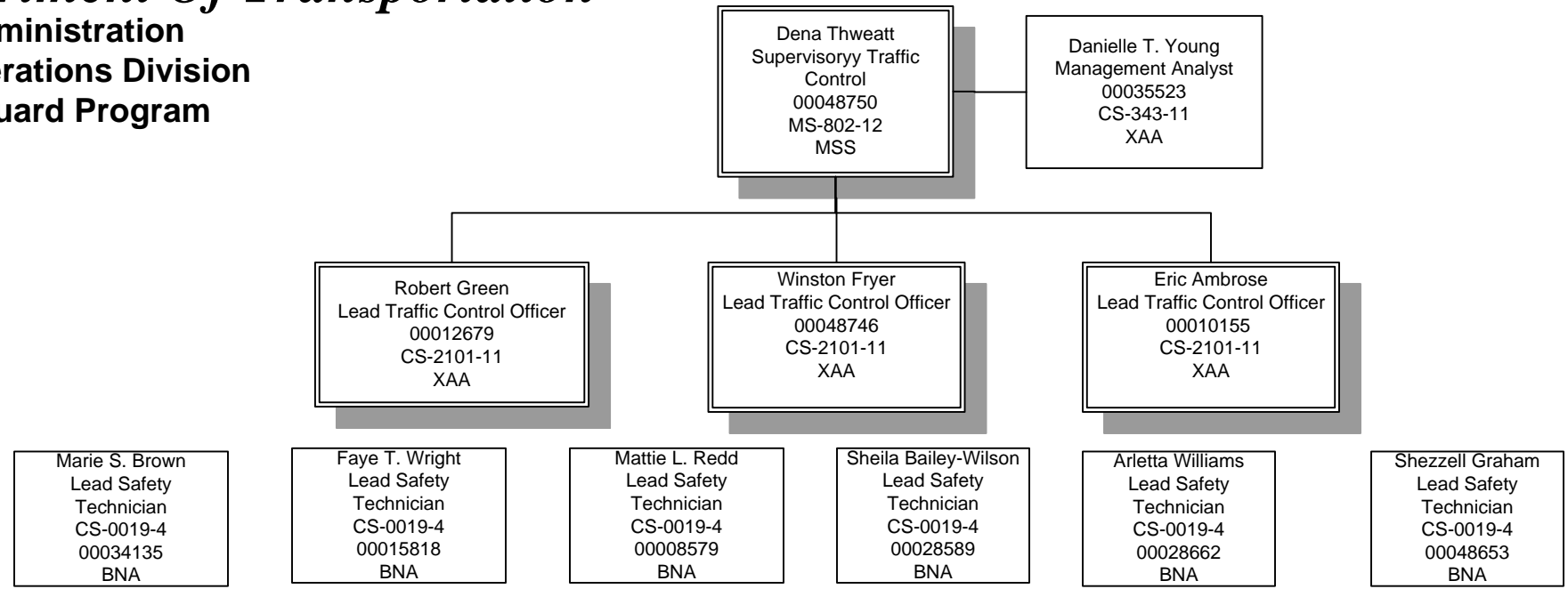

Tara Jones Safety Technician CS-0019-3 00013807 BNA	Yugenia Rogers Safety Technician CS-0019-3 00028590 BNA	Bobby Gray Safety Technician CS-0019-3 00028636 BNA	Edwina R. Gray Safety Technician CS-0019-3 00016989 BNA	Shakima Black Safety Technician CS-0019-2 00028635 BNA	Danielle Hall Safety Technician CS-0019-3 00019886 BNA	Stephanie Durant Safety Technician CS-0019-3 00028632 BNA	Shirley A. Howe Safety Technician CS-0019-3 00028704 BNA	Maurice Gaitling Safety Technician CS-0019-3 00048720 BNA
India Callaway Safety Technician CS-0019-3 00028640 BNA	Vera M Simon Safety Technician CS-0019-3 00015024 BNA	Earl Womble Safety Technician CS-0019-2 00045762 BNA	Cheryl Gibson Safety Technician CS-0019-3 00027358 BNA	Carole Prather-Wilson Safety Technician CS-0019-3 00028624 BNA	Dovona S. Henson Safety Technician CS-0019-3 00017029 BNA	Janette Brown Safety Technician CS-0019-3 00028597 BNA	Raynetta P. Rhodes Safety Technician CS-0019-3 00034151 BNA	Darlene P. Clark Safety Technician CS-0019-3 00026828 BNA
Chiquita D. Mills Safety Technician CS-0019-3 00034166 BNA	Latarsha Middleton Safety Technician CS-0019-3 00028709 BNA	Charlene Williams Safety Technician CS-0019-3 00028706 BNA	Shunell Kennedy Safety Technician CS-0019-3 00024422 BNA	Warren A. Burton Safety Technician CS-0019-3 00023923 BNA	Louise Davis Safety Technician CS-0019-3 00048634 BNA	Rhonda D. Pratt Safety Technician CS-0019-3 00017832 BNA	Dwane Brown Safety Technician CS-0019-3 00028637 BNA	Leslie Barnes Safety Technician CS-0019-3 00028596 BNA
Robert Edwards Safety Technician (Trainee) CS-0019-2 00028577 BNA	Jacqueline Reynolds Safety Technician CS-0019-3 00026624 BNA	Angela Lee Safety Technician CS-0019-3 00021731 BNA	Delva J. Dandridge Safety Technician CS-0019-3 00034150 BNA	Cynthia L. Lane Safety Technician CS-0019-3 00010798 BNA	Sharvon Redd Safety Technician CS-0019-3 00017605 BNA	Anita M. Brabham Safety Technician CS-0019-3 00020505 BNA	Deborah Williams Safety Technician CS-0019-2 00048662 BNA	Aisha Thomas Safety Technician CS-0019-2 00048684 BNA

School Crossing Control Program
 KA19132000

District Department Of Transportation

Traffic Services Administration Transportation Operations Division School Crossing Guard Program

Marie S. Brown
Lead Safety
Technician
CS-0019-4
00034135
BNA

Faye T. Wright
Lead Safety
Technician
CS-0019-4
00015818
BNA

Mattie L. Redd
Lead Safety
Technician
CS-0019-4
00008579
BNA

Sheila Bailey-
Wilson
Lead Safety
Technician
CS-0019-4
00028589
BNA

Arletta Williams
Lead Safety
Technician
CS-0019-4
00028662
BNA

Shezzell Graham
Lead Safety
Technician
CS-0019-4
00048653
BNA

Jennifer Blount
Safety Technician
CS-0019-2
00015187
BNA

Tracy D. Carter
Safety Technician
CS-0019-3
00023584
BNA

Arthur Bullock
Safety Technician
CS-0019-3
00022638
BNA

Angela Worthy
Safety Technician
CS-0019-2
00048669
BNA

Eric Shannon
Safety Technician
CS-0019-3
00028622
BNA

Robert Slye
Safety Technician
CS-0019-2
00003746
BNA

Cynthia L. Clark
Safety Technician
CS-0019-3
00028675
BNA

Phyllis J. Johnson
Safety Technician
CS-0019-3
00016325
BNA

Barbara E. Pinkney
Safety Technician
CS-0019-3
00022225
BNA

Donna Butler
Safety Technician
CS-0019-3
00016764
BNA

Natasha Thomas
Safety Technician
CS-0019-2
00015650
BNA

Phyllis A. Jordan
Safety Technician
CS-0019-3
00020161
BNA

Eula M Brinson
Safety Technician
CS-0019-3
00009678
BNA

Joann Brinkley
Safety Technician
CS-0019-3
00017766
BNA

Delores V. Clark
Safety Technician
CS-0019-3
00028673
BNA

Carolyn R. Smith
Safety Technician
CS-0019-3
00021903
BNA

Joyce Brown
Safety Technician
CS-0019-3
00034133
BNA

Thomasine Garvin
Safety Technician
CS-0019-3
00016640
BNA

Robert Hargrove
Safety Technician
CS-0019-3
00010186
BNA

Melissa A. Thomas
Safety Technician
CS-0019-3
00022765
BNA

Natasha Broadus
Safety Technician
CS-0019-2
00048649
BNA

Francine Gray
Safety Technician
CS-0019-2
00021114
BNA

Cornelius Alston
Safety Technician
CS-0019-3
00017791
BNA

Sharon D. Pyles
Safety Technician
CS-0019-3
00009426
BNA

Thomas Cunningham
Safety Technician
CS-0019-2
00010294
BNA

Tavist Alston
Safety Technician
CS-0019-3
00020995
BNA

Michael Ford, Sr.
Safety Technician
CS-0019-2
00048719
BNA

Felicia R. Allen
Safety Technician
CS-0019-3
00023112
BNA

Tynia Butler
Safety Technician
CS-0019-3
00071369
BNA

Diana Robinson
Safety Technician
CS-0019-2
00024316
BNA

Odessa E. Grant
Safety Technician
CS-0019-3
00010674
BNA

Monica Williams
Safety Technician
CS-0019-3
00022912
BNA

Linice Alston
Safety Technician
CS-0019-2
00048665
BNA

Darlene E. Hinson
Safety Technician
CS-0019-3
00025698
BNA

Emma J Royster
Safety Technician
CS-0019-3
00015795
BNA

Darlene G. Jones
Safety Technician
CS-0019-3
00025696
BNA

Lucette Goodwyn
Safety Technician
CS-0019-3
00015225
BNA

Latoya Holloman
Safety Technician
CS-0019-2
00015835
BNA

Joseph Hawkins
Safety Technician
CS-0019-2
00048651
BNA

Antonio J. Morrobel
Safety Technician
CS-0019-3
00025778
BNA

Alicia Davis
Safety Technician
CS-0019-2
00048657
BNA

Saprina Dowdy
Safety Technician
CS-0019-3
00005075
BNA

Candace Deal
Safety Technician
CS-0019-3
00010533
BNA

Reacie W. Lindsey
Safety Technician
CS-0019-3
00015138
BNA

Kim A. Cook
Safety Technician
CS-0019-3
00021794
BNA

District Department Of Transportation

Transportation Operations Administration Transportation Operations Division School Crossing Guard Program

Marie S. Brown
Lead Safety
Technician
CS-0019-4
00034135
BNA

Faye T. Wright
Lead Safety
Technician
CS-0019-4
00015818
BNA

Mattie L. Redd
Lead Safety
Technician
CS-0019-4
00008579
BNA

Sheila Bailey-
Wilson
Lead Safety
Technician
CS-0019-4
00028589
BNA

Arletta Williams
Lead Safety
Technician
CS-0019-4
00028662
BNA

Shezzell Graham
Lead Safety
Technician
CS-0019-4
00048653
BNA

Ronald Burrell
Safety Technician
CS-0019-2
00048668
BNA

Tamia Foster
Safety Technician
CS-0019-2
00021012
BNA

Pheisha Blake
Safety Technician
CS-0019-2
00022047
BNA

Alice McPhatter
Safety Technician
CS-0019-2
00048683
BNA

Larry Wyder
Safety Technician
CS-0019-2
00048633
BNA

Shatonya Nicholson
Safety Technician
CS-0019-2
00048663
BNA

Shirley Rice
Safety Technician
CS-0019-3
00048676
BNA

Edward Hall
Safety Technician
CS-0019-2
00048694
BNA

Deborah Taylor-
Womack
Safety Technician
CS-0019-2
00048619
BNA

Gloria J. Lassiter
Safety Technician
CS-0019-3
00009698
BNA

Tan Eka Sharpe
Safety Technician
CS-0019-2
00048721
BNA

Yolanda D. Coleman
Safety Technician
CS-0019-2
00016809
BNA

Machelle Gantt
Safety Technician
CS-0019-3
00016994
BNA

Barbara Crosby
Safety Technician
CS-0019-3
00015191
BNA

Geraldine Daniels
Safety Technician
CS-0019-2
00007817
BNA

Kumlachew Belete
Safety Technician
CS-0019-2
00025046
BNA

Sandra Jiminez
Safety Technician
CS-0019-2
00048630
BNA

Claudia M. Alvin
Safety Technician
CS-0019-3
00020608
BNA

Makia Moten
Safety Technician
CS-0019-2
00045737
BNA

Shanika Horton
Safety Technician
CS-0019-2
00048661
BNA

Patricia Morton
Safety Technician
CS-0019-2
00026631
BNA

Arletta M. Williams
Lead Safety
Technician
CS-0019-4
00028662
BNA

Theresa Johnson
Safety Technician
CS-0019-2
00048606
BNA

Kay DeLoatch
Safety Technician
CS-0019-2
00024691
BNA

Antionette Millard
Safety Technician
CS-0019-3
00009984
BNA

Earlene Bundy
Safety Technician
CS-0019-2
00048624
BNA

Muriel Weathington
Safety Technician
CS-0019-3
00024240
BNA

Towanda Conner
Safety Technician
CS-0019-2
00019605
BNA

Laverne Bell Jones
Safety Technician
CS-0019-3
00016774
BNA

Mary L. Scott
Safety Technician
CS-0019-3
00011330
BNA

Mary Hillian
Safety Technician
CS-0019-2
00019660
BNA

Pamela Wright Hodo
Safety Technician
CS-0019-2
00027571
BNA

Kenny Dudley
Safety Technician
CS-0019-2
00048632
BNA

Pauline B. Peterson
Safety Technician
CS-0019-3
00015211
BNA

Mary L. Smith
Safety Technician
CS-0019-3
00024135
BNA

Alberta Pearson
Safety Technician
CS-0019-3
00025009
BNA

Daniel Wilder
Safety Technician
CS-0019-2
00009184
BNA

Sheila Abney-Minor
Safety Technician
CS-0019-2
00048622
BNA

Eric Thorpe
Safety Technician
CS-0019-2/3
00018453
BNA

Dominique Copeland
Safety Technician
CS-0019-2
00048666
BNA

Danielle Hall
Safety Technician
CS-0019-2/3
00019886
BNA

Darrell Wilkinson
Safety Technician
CS-0019-2/3
00007627
BNA

Lortrice Watkins
Safety Technician
CS-0019-2
00048614
BNA

Ella Smith
Safety Technician
CS-0019-2
00048615
BNA

Tomorrow Hall
Safety Technician
CS-0019-02
00048670
BNA

District Department Of Transportation

Traffic Services Administration Transportation Operations Division School Crossing Guard Program

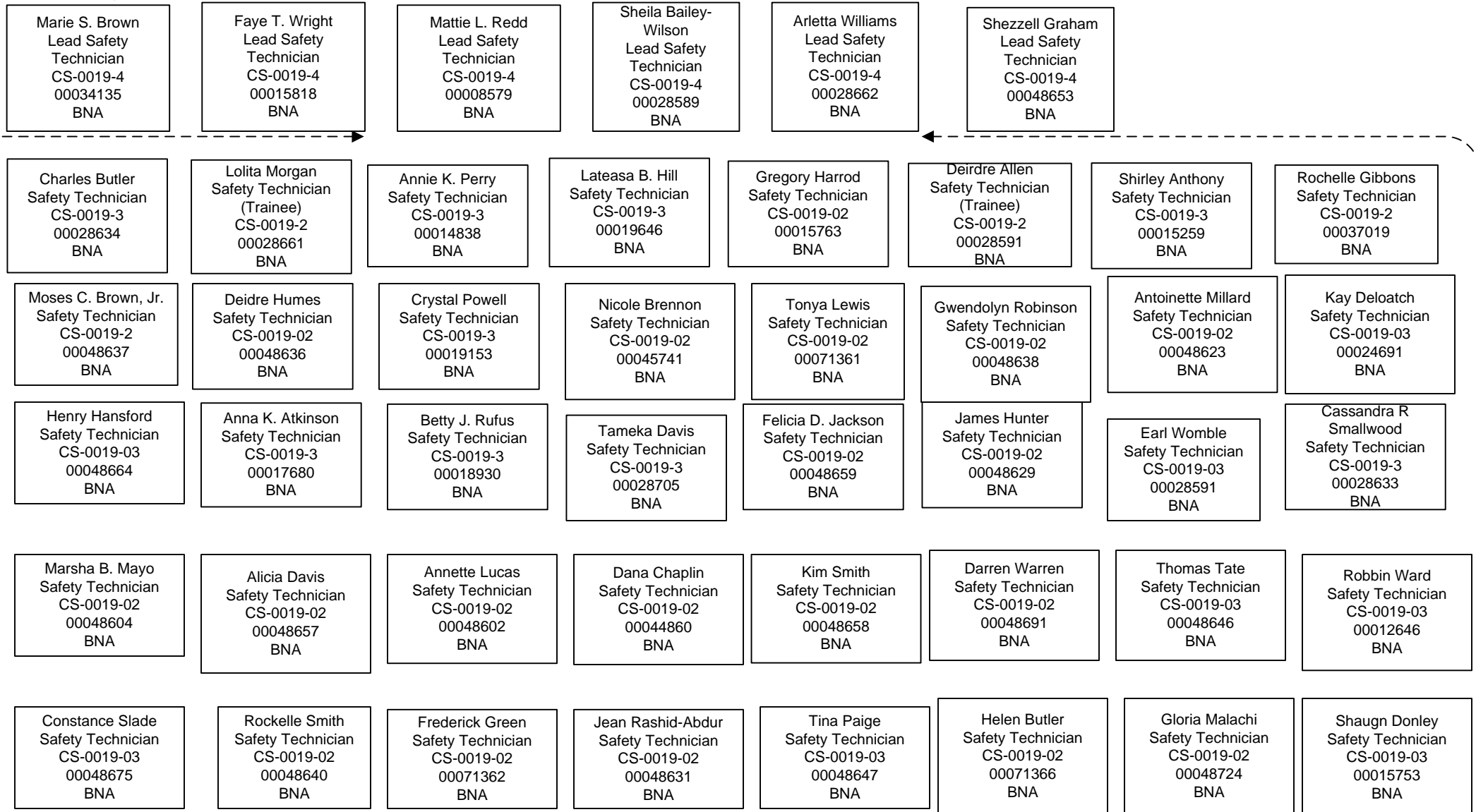

District Department Of Transportation

Transportation Operations Administration

Transportation Operations Division

School Crossing Guard Program

Marie S. Brown
Lead Safety
Technician
CS-0019-4
00034135
BNA

Faye T. Wright
Lead Safety
Technician
CS-0019-4
00015818
BNA

Mattie L. Redd
Lead Safety
Technician
CS-0019-4
00008579
BNA

Sheila Bailey-
Wilson
Lead Safety
Technician
CS-0019-4
00028589
BNA

Arletta Williams
Lead Safety
Technician
CS-0019-4
00028662
BNA

Shezzell Graham
Lead Safety
Technician
CS-0019-4
00048653
BNA

Darryl Oden
Safety Technician
CS-0019-02
00048677
BNA

Rosalind Tymus
Safety Technician
CS-0019-03
00048641
BNA

Kareema Thomas
Safety Technician
CS-0019-02
00048660
BNA

Sheila Spencer
Safety Technician
CS-0019-02
00048654
BNA

Theresa M Offutt
Safety Technician
CS-0019-02
00048672
BNA

Bernice Blackwell-
White
Safety Technician
CS-0019-03
00048690
BNA

John Howard, Jr.
Safety Technician
CS-0019-03
00048695
BNA

Brendella Greely
Safety Technician
CS-0019-02
00048645
BNA

Joseph Powell
Safety Technician
CS-0019-03
00048673
BNA

Sheila Walker
Safety Technician
CS-0019-02
00048667
BNA

Stacy Harvey
Safety Technician
CS-0019-02
00048725
BNA

Kimberly Ware
Safety Technician
(Trainee)
CS-0019-02
00045333
BNA

Stephon Vereene
Safety Technician
(Trainee)
CS-0019-02
00048635
BNA

Vacant
Safety Technician
CS-0019-2
00021804
BNA

Vacant
Safety Technician
CS-0019-2
00048623
BNA

Vacant
Safety Technician
CS-0019-3
00048656
BNA

Vacant
Safety Technician
CS-0019-2
00048616
BNA

Vacant
Safety Technician
CS-0019-3
00048685
BNA

Vacant
Safety Technician
CS-0019-2
00022676
BNA

Vacant
Safety Technician
CS-0019-02
00048643
BNA

Vacant
Safety Technician
CS-0019-02
00048639
BNA

Vacant
Safety Technician
CS-0019-2
00028672
BNA

Vacant
Safety Technician
CS-0019-2
00028575
BNA

Vacant
Safety Technician
CS-0019-03
00048686
BNA

District Department Of Transportation

Transportation Operations Administration

Traffic Services Field Operations Division

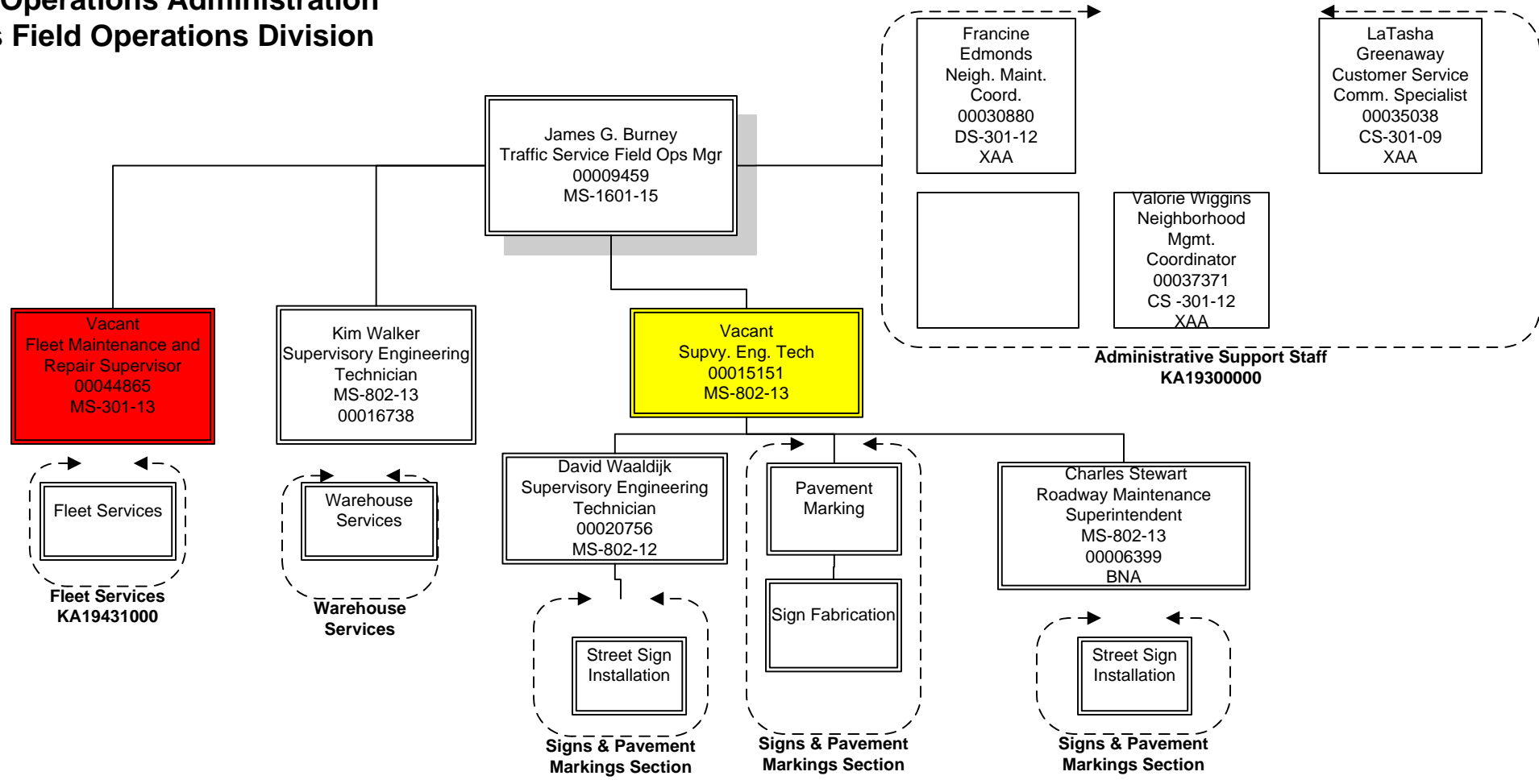

Detail:
Turnesha Cook, TST

District Department Of Transportation

Transportation Operations Administration
Traffic Services Field Operations Division
Sign & Pavement Markings Section-Part 1

Vacant
Supvy. Eng. Tech.
00015151
Ms-802-13
MSS

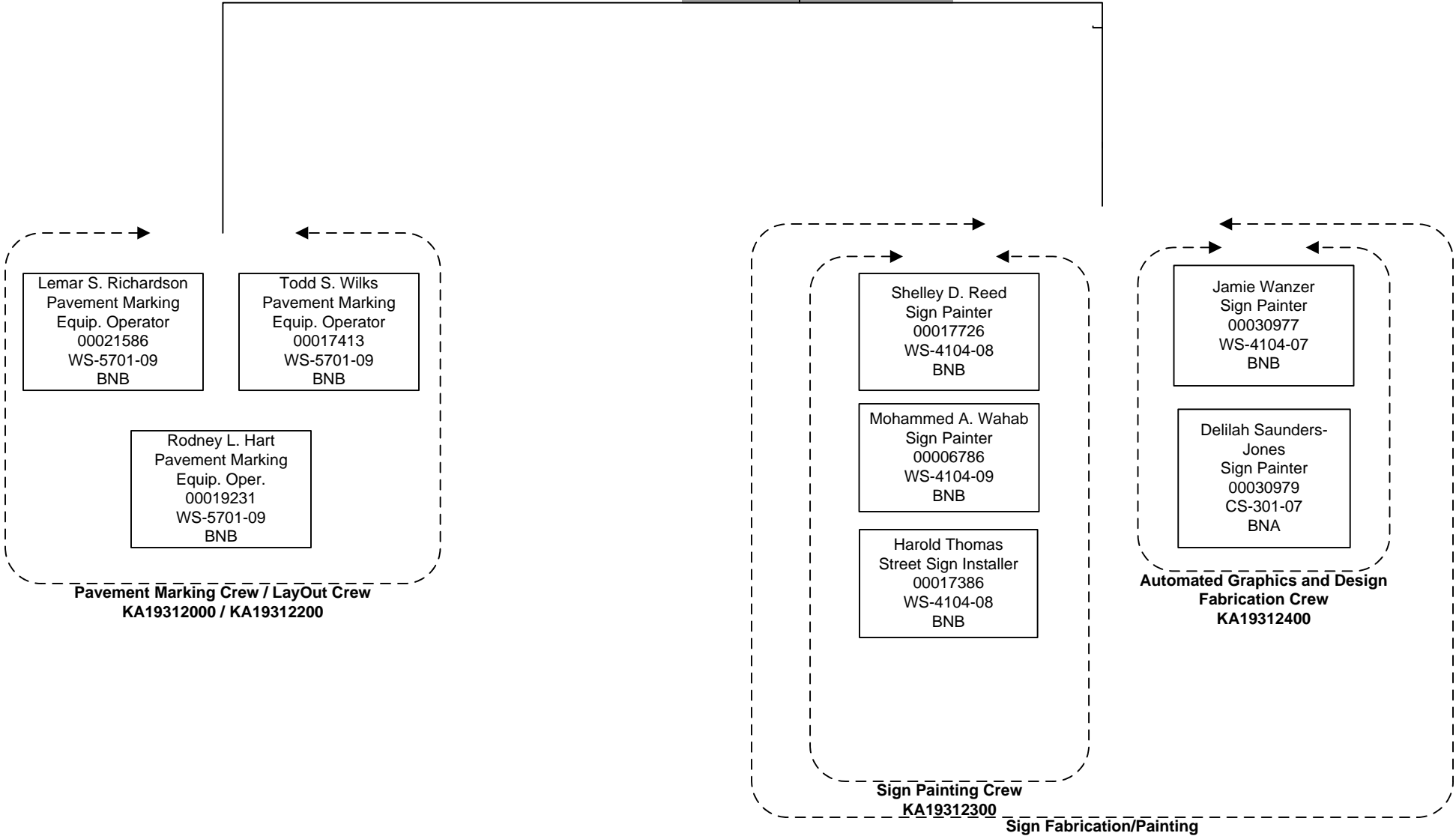

District Department Of Transportation

Transportation Operations Administration

Traffic Services Field Operations Division

Sign & Pavement Markings Section-Part 2

Vacant
Supvy. Eng. Tech.
00015151
MS-802-13
MSS

David Waaldijk
Supervisory Engineering
Technician
00025706
MS-802-12
MSS

Charles Stewart
Roadway Maintenance
Superintendent
00006399
MS-802-13
MSS

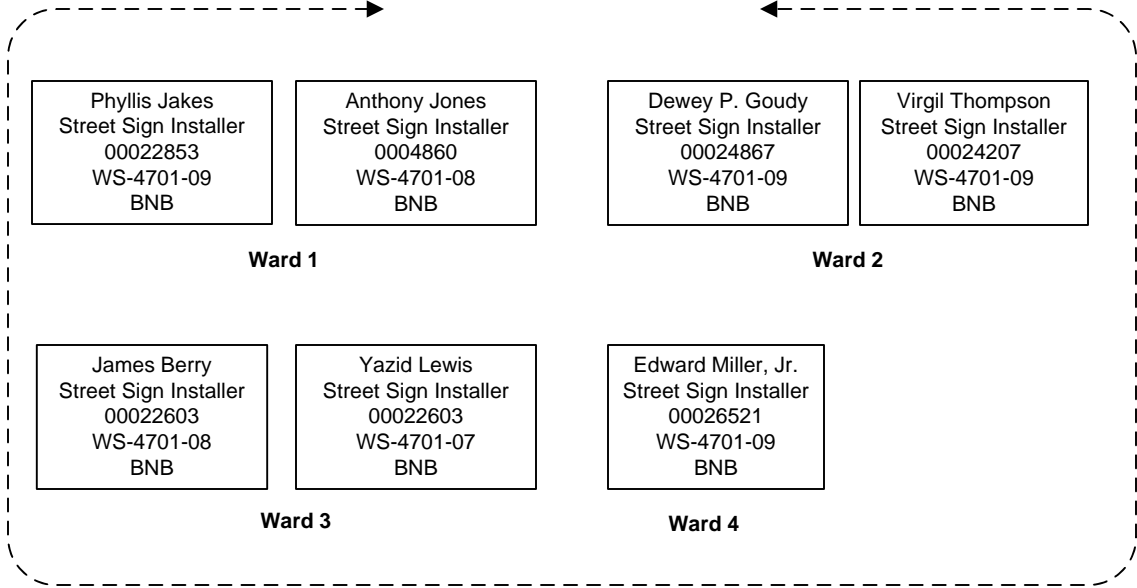

Wards 1-4

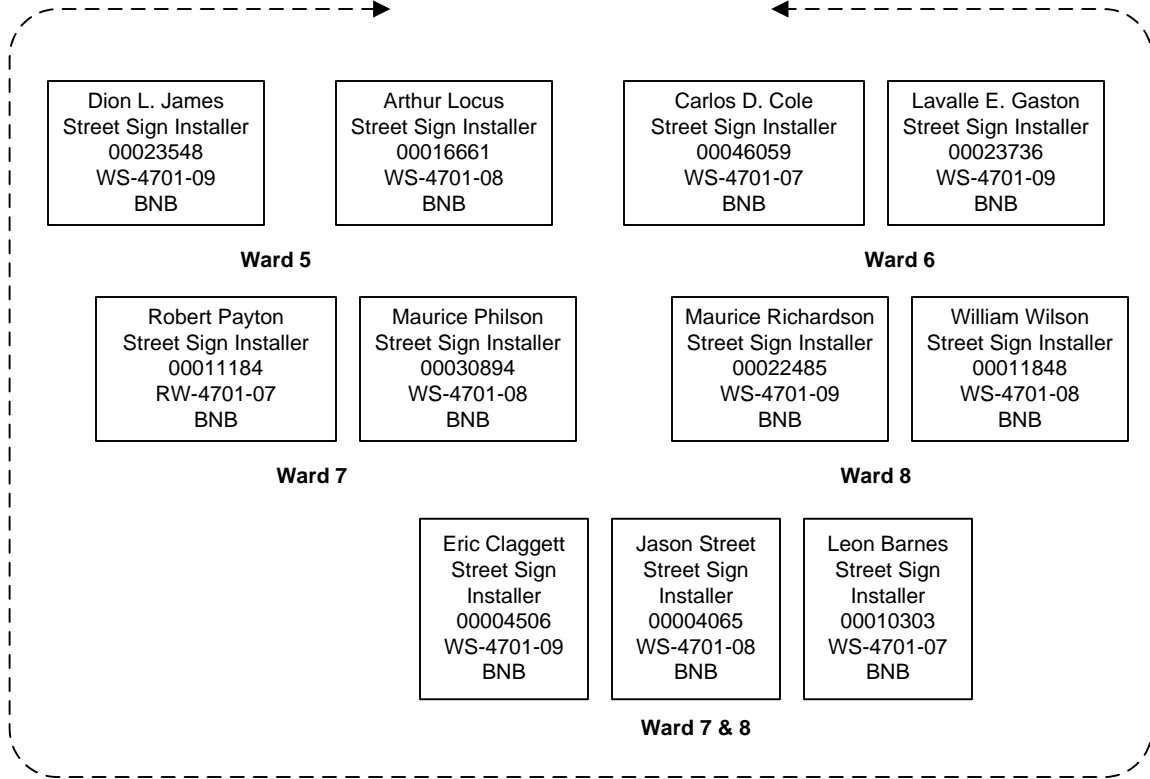

Wards 5-7

Ward 7 & 8

District Department Of Transportation

Transportation Operations Administration
Traffic Services Field Operations Division
Fleet Management / Warehouse Services

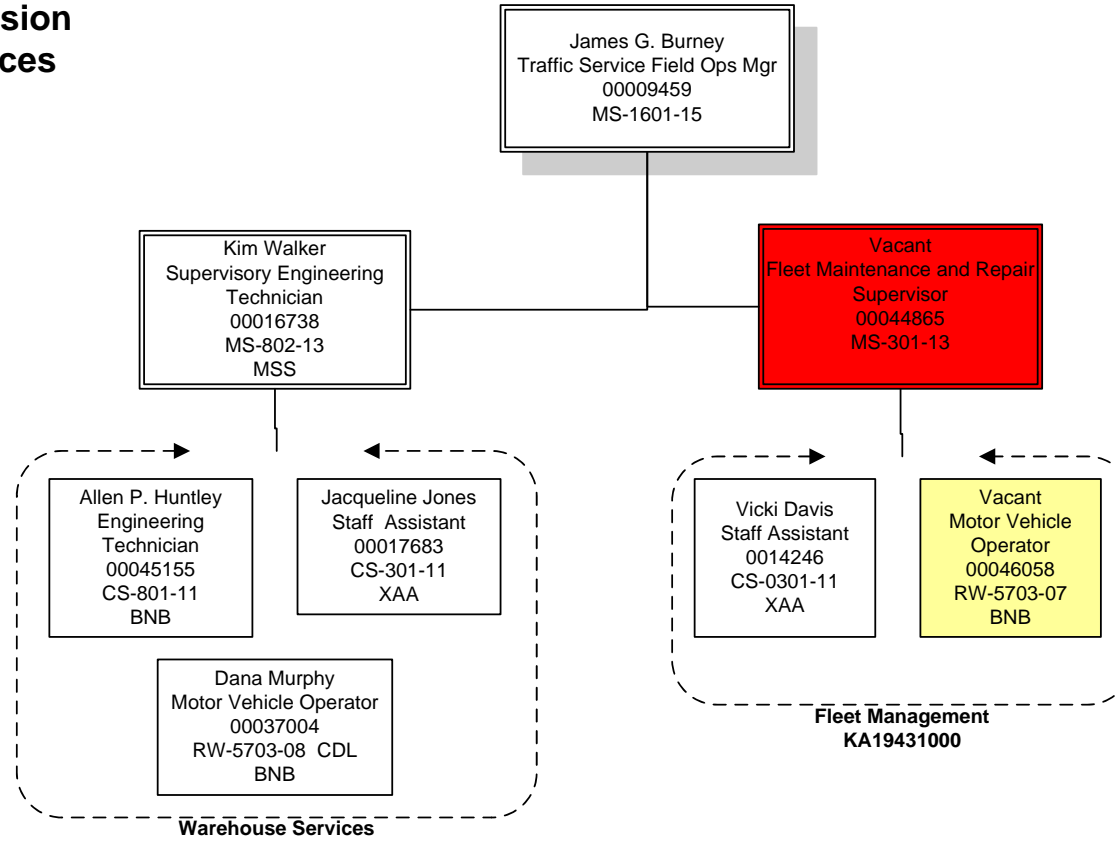

District Department Of Transportation

Transportation Operations Administration

Street & Bridge Maintenance Division

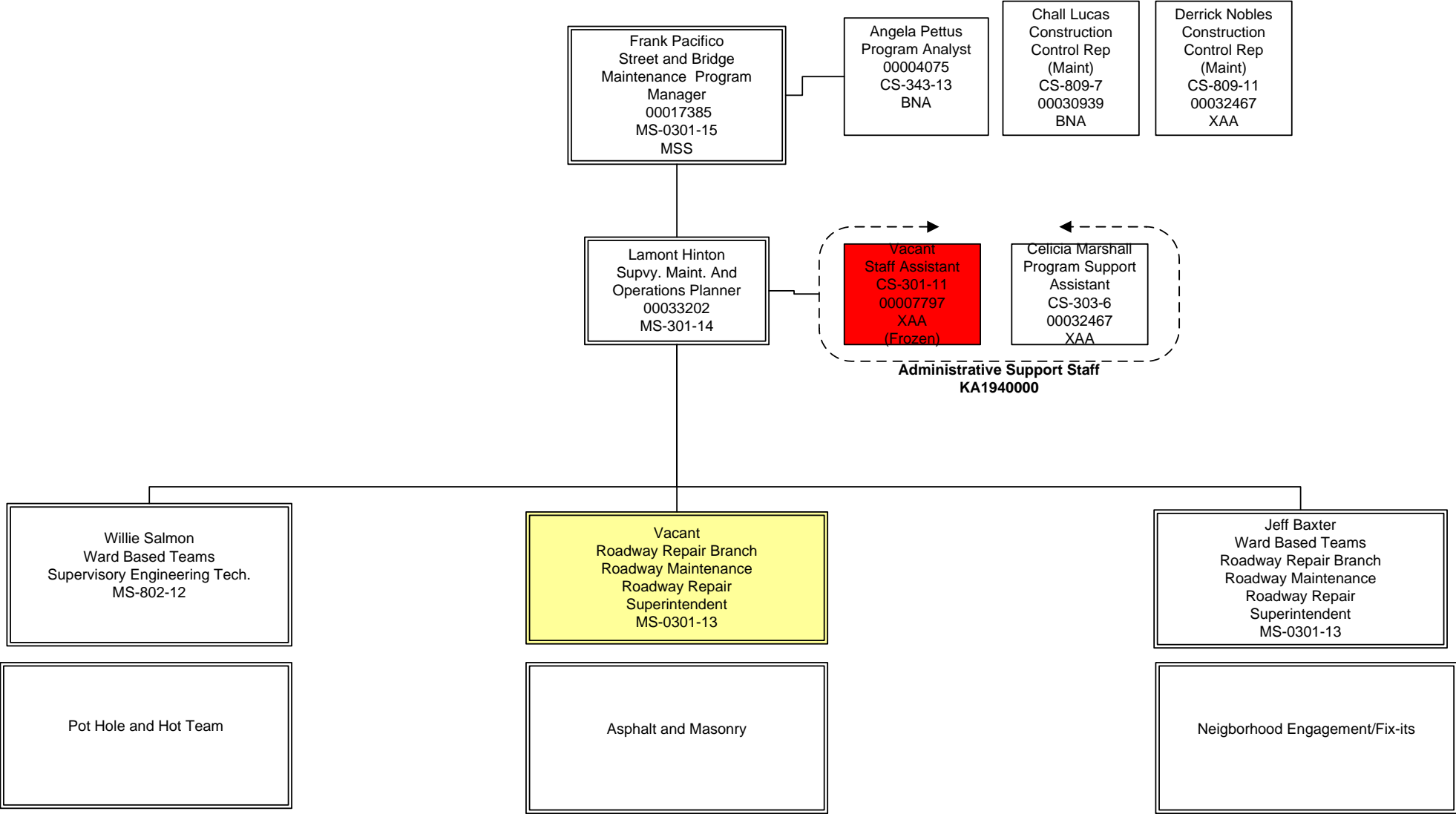

District Department Of Transportation
Transportation Operations Administration
Street & Bridge Maintenance Division
Roadway Maintenance Section

Willie Salmon
 Supervisory Engineering Tech.
 00020576
 MS 802-12
 MSS

Tritty Ross
 Roadway Maintenance
 Supervisor
 00024120
 SW-3601-07
 XAA

Robert Morris
 Asphalt Worker Foreman
 00023011
 SW-3653-06
 XAA

Anthony Owens
 Asphalt Worker Foreman
 00018421
 SW-3653-06
 XAA

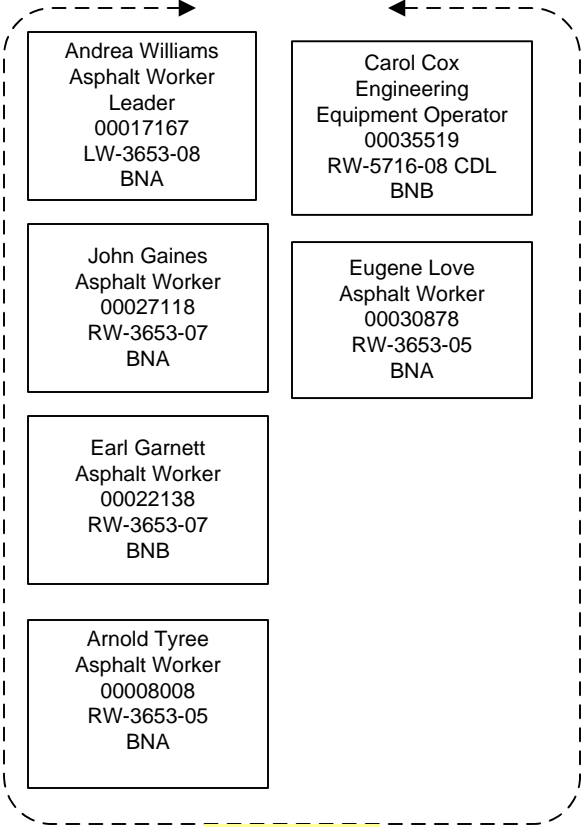

Wards 1, 2, 7, & 8
KA19411000

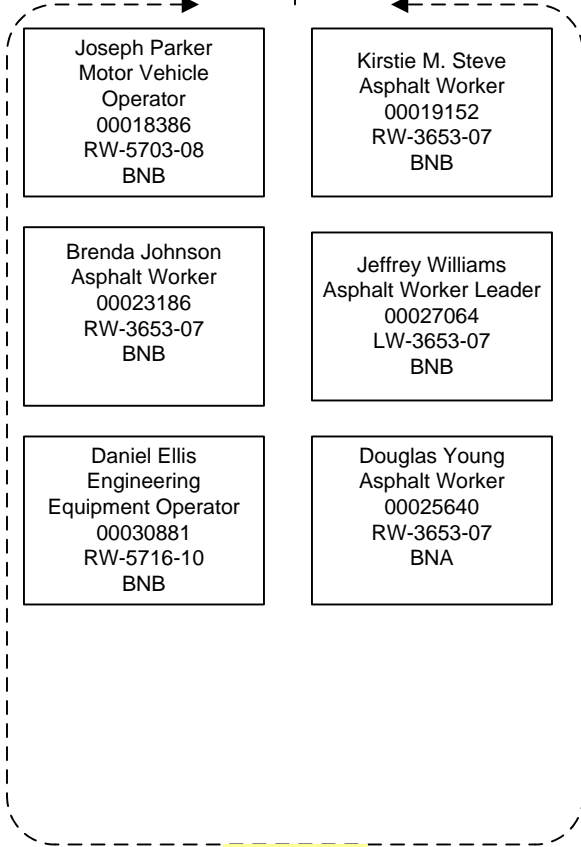

Wards 3 and 4
KA19412000

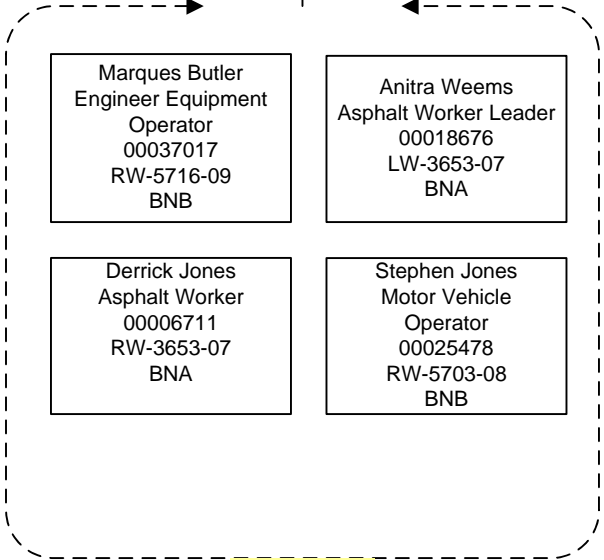

Wards 5 and 6
KA19413000

District Department Of Transportation

Transportation Operations Administration

Street & Bridge Maintenance Division

Roadway Repair Section

Vacant
 Superintendent, Street and
 Bridge Maintenance
 00013947
 MS-0301-13

Donald A. Ferrell
 Roadway Maint.
 Supervisor
 00021923
 SW-3601-07
 XAA

Anthony G. Wooten
 Roadway Maint.
 Supervisor
 00006402
 SW 3601 7
 XAA

Anthony G. Wooten
 Roadway Maint.
 Supervisor
 00006402
 SW 3601-07
 XAA

James Whren
 Roadway Maintenance
 Supervisor
 00019987
 SW 3601-7
 XAA

Richard Rosebar
 Asphalt Worker Leader
 00005268
 LW-3653-07
 BNB

Anthony Bell
 Engineering
 Equipment Operator
 00037012
 RW-5716-11
 BNB

Joseph Thomas
 Motor Vehicle
 Operator
 00030959
 RW-5703-07
 BNB

Myron Gross
 Asphalt Worker
 00017435
 RW-3653-05
 BNB

Clifton Johnson
 Asphalt Worker
 00037201
 RW-3653-05
 BNA

James Clayton
 Motor Vehicle
 Operator
 00016619
 RW-5703-08
 BNB

Thomas Bell Jr.
 Engineering
 Equipment Operator
 00015298
 RW-5716-11
 BNB

Robert Callaham
 Motor Vehicle
 Operator
 00003327
 RW-5703-08
 BNB

Barrington Chappelle
 Motor Vehicle
 Operator
 00012861
 RW-5703-08
 BNB

Bradley Murchinson
 Asphalt Worker
 00017370
 RW-3653-07
 BNA

Benjamin Wheeler
 Motor Vehicle
 Operator
 00037005
 RW-5703-08
 BNB

Clifford Lancaster
 Engineering
 Equipment Operator
 00030958
 RW-5716-10
 BNB

Garrett Jackson
 Motor Vehicle
 Operator
 00037000
 RW-5703-08
 BNB

Vacant
 Asphalt Worker Leader
 00017564
 LW-3653-07
 BNB
 (Frozen)

Vacant
 Engineering Equipment
 Operator
 00019239
 RW-5716-09
 BNB
 (Frozen)

Vacant
 Motor Vehicle Operator
 00017351
 RW-5103-7
 BNA
 (Frozen)

Michael Nelson
 Engineering Equip
 Operator
 00015851
 RW-5716-10
 BNA

Vacant
 Laborer
 00018512
 RW-3502-03
 BNA
 (Frozen)

Donald Johnson
 Motor Vehicle
 Operator
 00037002
 RW-5703-08
 BNB

Kenneth Smith
 Engineering
 Equipment Operator
 00037016
 RW-5716-11
 BNB

Hasan Taquee
 Asphalt Worker
 00045142
 RW-3653-05
 BNA

Joanell Russell
 Motor Vehicle Operator
 00033623
 RW-5703-08
 BNA

Bernard Jackson
 Engineering
 Equipment Operator
 00019831
 RW-5716-11
 BNB

Michael Jackson
 Motor Vehicle
 Operator
 00037001
 RW-5703-08
 BNB

Anthony Miller
 Asphalt Worker Leader
 00014573
 LW-3653-07
 BNB

George Miller
 Motor Vehicle
 Operator
 00023146
 RW-5703-07
 BNB

Lorenzo Miller
 Motor Vehicle Operator
 00022879
 RW-5703-08
 BNA

Vacant
 Motor Vehicle Operator
 00020630
 RW-5703-07
 BNA

Reginald Mathis
 Motor Vehicle
 Operator
 00024482
 RW-5703-08
 BNB

Renee Morrison
 Asphalt Worker Leader
 00024929
 LW-3653-03
 BNB

Speed Hump Unit
 KA19421000

Milling /Spray Patch Unit
 KA19422000

Paving Unit
 KA19423000

Alley Crew
 KA19423000 / KA19428000

District Department Of Transportation

Transportation Operations Administration

Street & Bridge Maintenance Division

Roadway Repair Section-Part 2

Vacant
Superintendent, Street and
Bridge Maintenance
00013947
MS-0301-13

James Whren
Roadway Maintenance
Supervisor
00019987
SW 3601-7
XAA

Donald A. Ferrell
Roadway Maint.
Supervisor
00021923
SW-3601-07
XAA

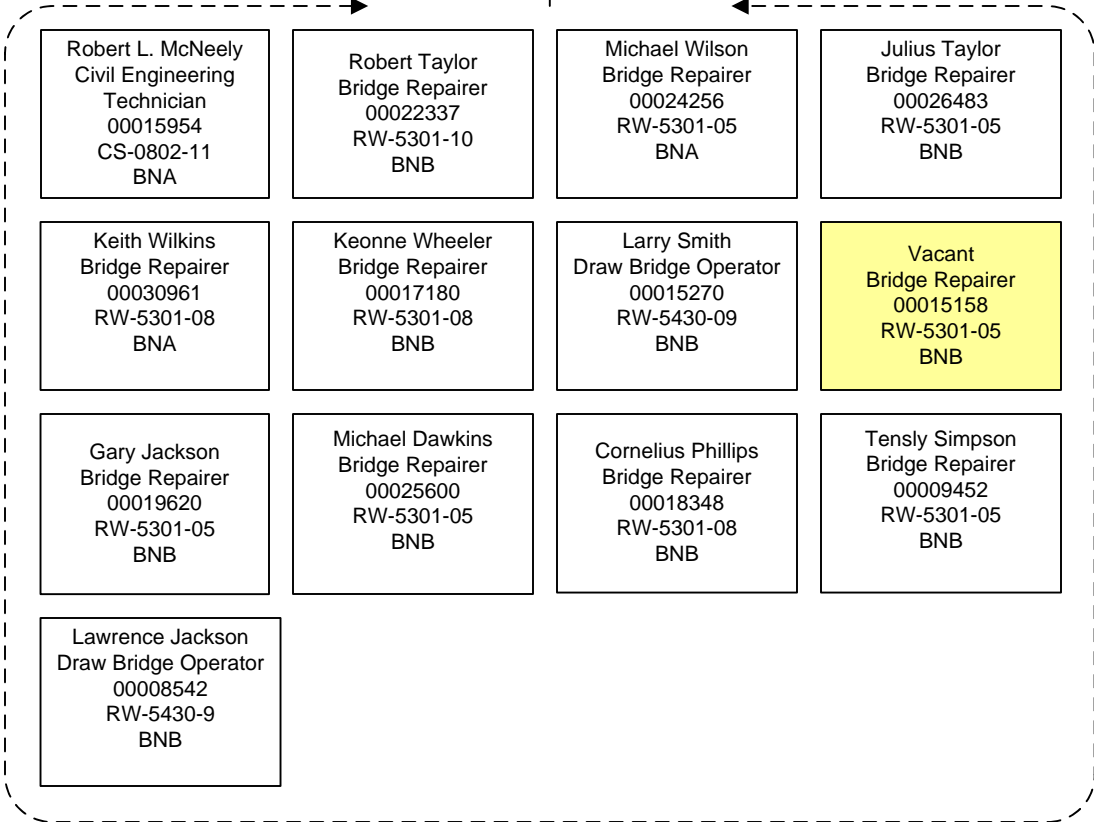

Bridge Operations Unit
KA19424000

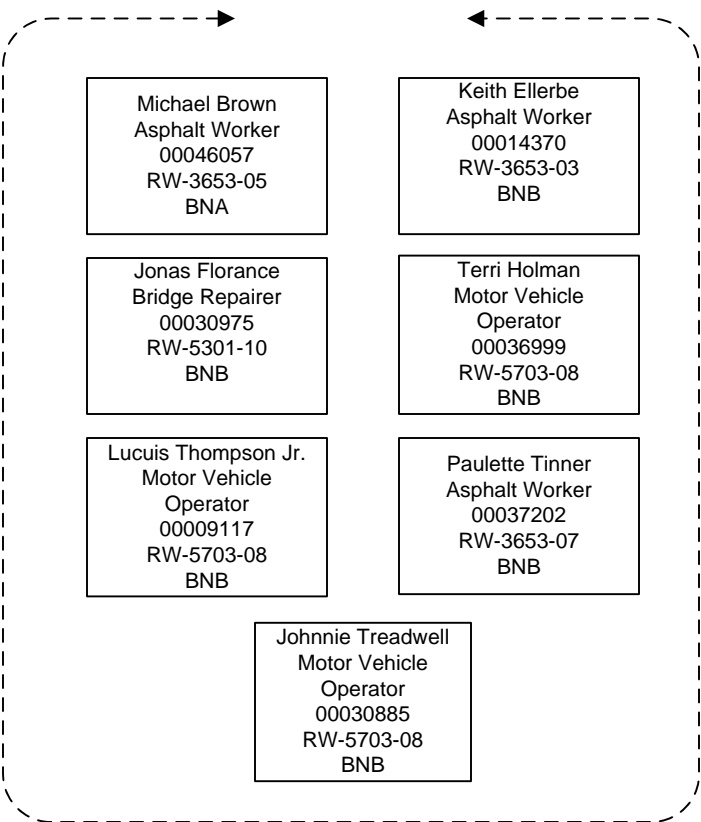

Alley Paving Crew
KA19425000

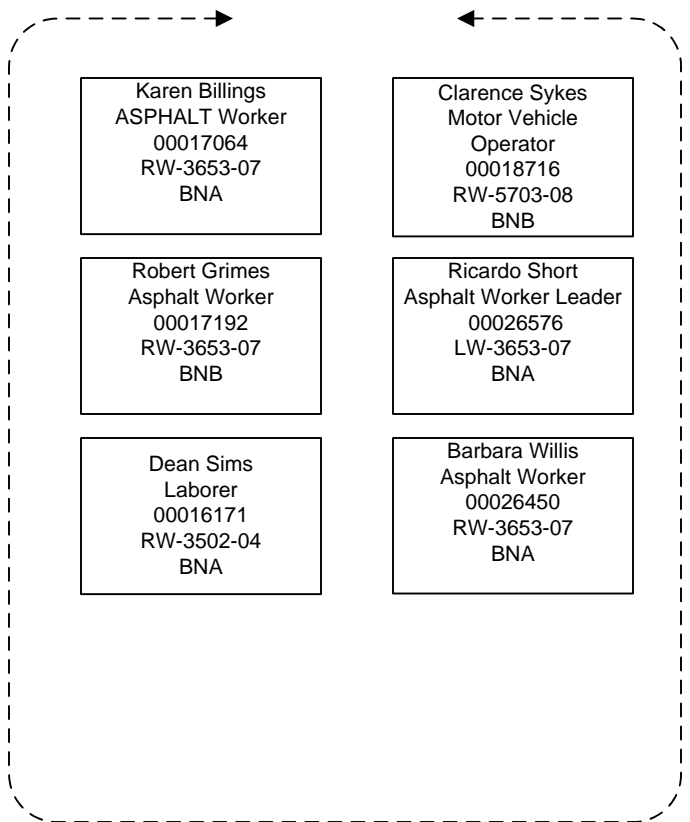

Crack Seal Unit
KA19425000

District Department Of Transportation

Transportation Operations Administration

Street & Bridge Maintenance Division

Roadway Repair Section-Part 3 / Heavy

Equipment Operations

CURRENT

Jeff Baxter Superintendent, Equipment Operations 00006774 MS-301-13 MSS	Charles Tenbrook Customer Service Comm Specialist 00008196 CS-0303-09 XAA
--	--

James Glaspie Equipment Operations Supervisor 00024879 MS-4701-11

Vacant Roadway Maint. Supervisor 00018569 SW-3601-07 XAA

Vacant Roadway Maint. Supervisor 00003954 SW-3601-07 XAA

Roland Jones Masonry Worker 00016541 RW-3603-08 BNB	Vacant Masonry Worker 00014505 RW-3603-08 BNB	James Banks Masonry Worker 00030924 RW-3603-08 BNB
Donnell Willis Asphalt Worker 00023979 RW-3653-05 BNB	Barry Saunders Asphalt Worker 00020573 RW-3653-05 BNB	Derrick Brown Motor Vehicle Operator 00046063 RW-5703-07 BNB
Victor Modenessi Asphalt Worker 00030942 RW-3653-05 BNB	Jose Silva Asphalt Worker 00022687 RW-3653-05 BNB	

Roadway/Concrete Brick Maintenance Unit
KA19427000

Osborne Lake Motor Vehicle Operator 00037004 RW-5703-07 BNB	Arnell Gaines Asphalt Worker 00020384 RW-3653-07 BNB
Michael Mims Asphalt Worker 00030878 RW-3653-05 BNB	Robert Hazel Motor Vehicle Operator 00018550 RW-5703-07 BNB
Vacant Laborer 00015421 RW-3502-03 BNB	Aaron Mahoney Motor Vehicle Operator 00027044 RW-5701-07 BNB

2nd Shift

Terrance Gamble Motor Vehicle Operator 00036956 RW-5703-08 BNB	Vacant Engineering Equip Operator 00037011 RW-5716-11 BNA (Frozen)
Antonio Burnette Motor Vehicle Operator 00019126 RW-5703-08 BNA	Ronny Dowe Motor Vehicle Operator 00037007 RW-5703-08 BNB
Ronald Miller Asphalt Worker 00020835 RW-3653-07 BNA	Rashaad Short Engineering Equip Operator 00046068 RW-5716-10 BNA
Lawrence E. Hoes Asphalt Worker 00025365 RW-3653-05 BNB	Brenda Bailey Motor Vehicle Operator 00023945 RW-5701-07 BNA

Equipment Maintenance
KA19430000