

**District Department of Transportation
Office of the Director
Senior Level**

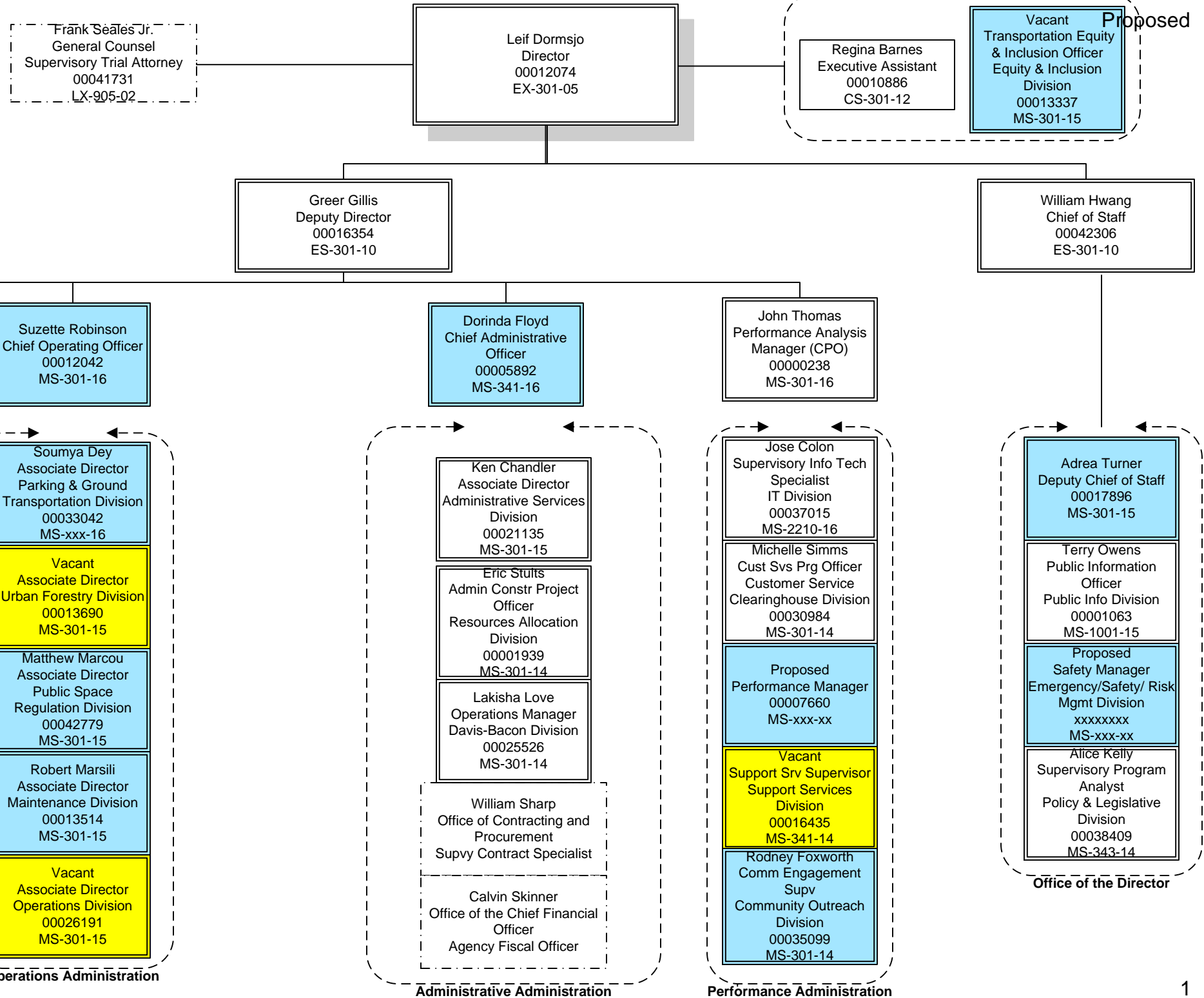

Approved by: Leif A. Dormsjo, Director

Signature: _____ Date: _____

District Department of Transportation
Office of the Director

Proposed

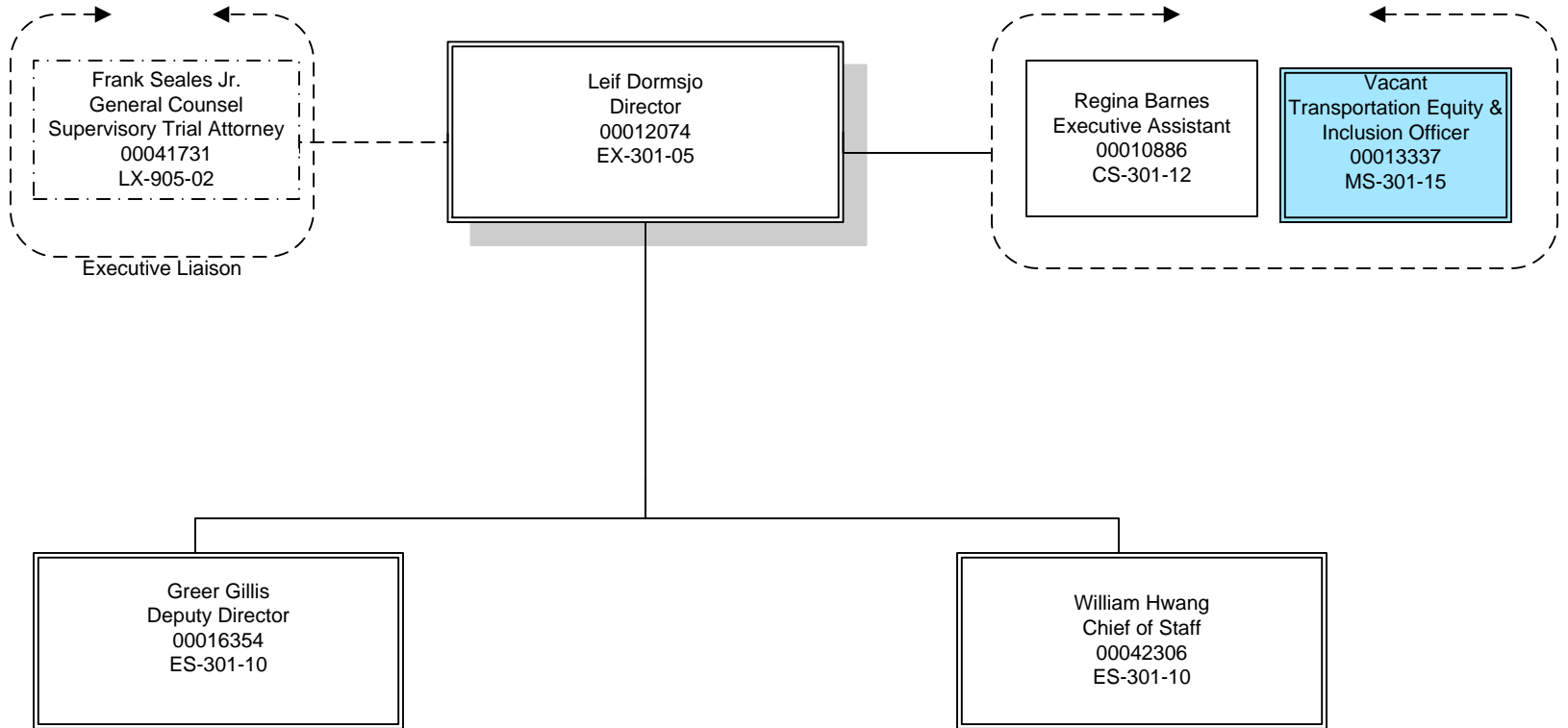

Approved by: Leif A. Dormsjo, Director

Signature: _____ Date: _____

**District Department of Transportation
Office of the Director
Equity & Inclusion Division**

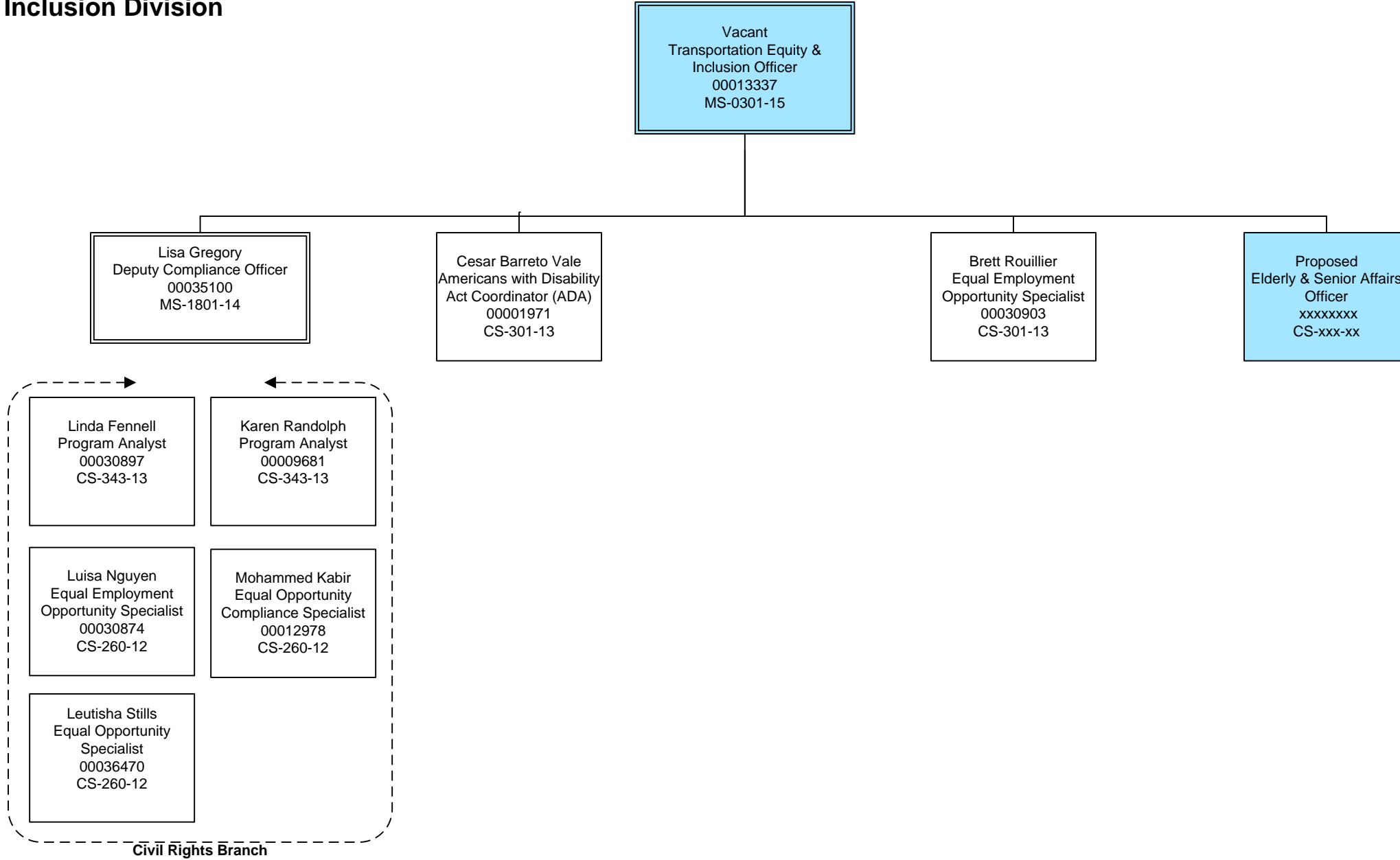

Approved by: Leif A. Dormsjo, Director

Signature: _____ Date: _____

**District Department of Transportation
Office of the Director
Office of the Deputy Director**

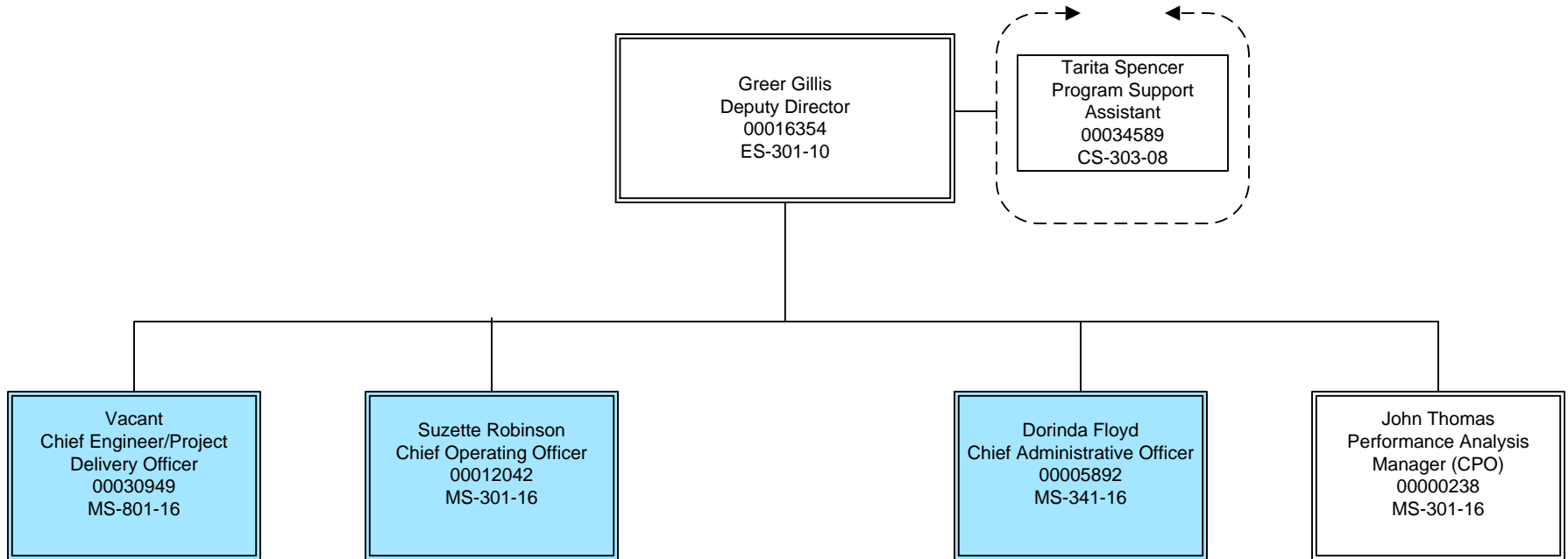

Approved by: Leif A. Dormsjo, Director

Signature: _____ Date: _____

District Department of Transportation
Project Delivery Administration
Office of the Chief Engineer Project
Delivery Officer

Proposed

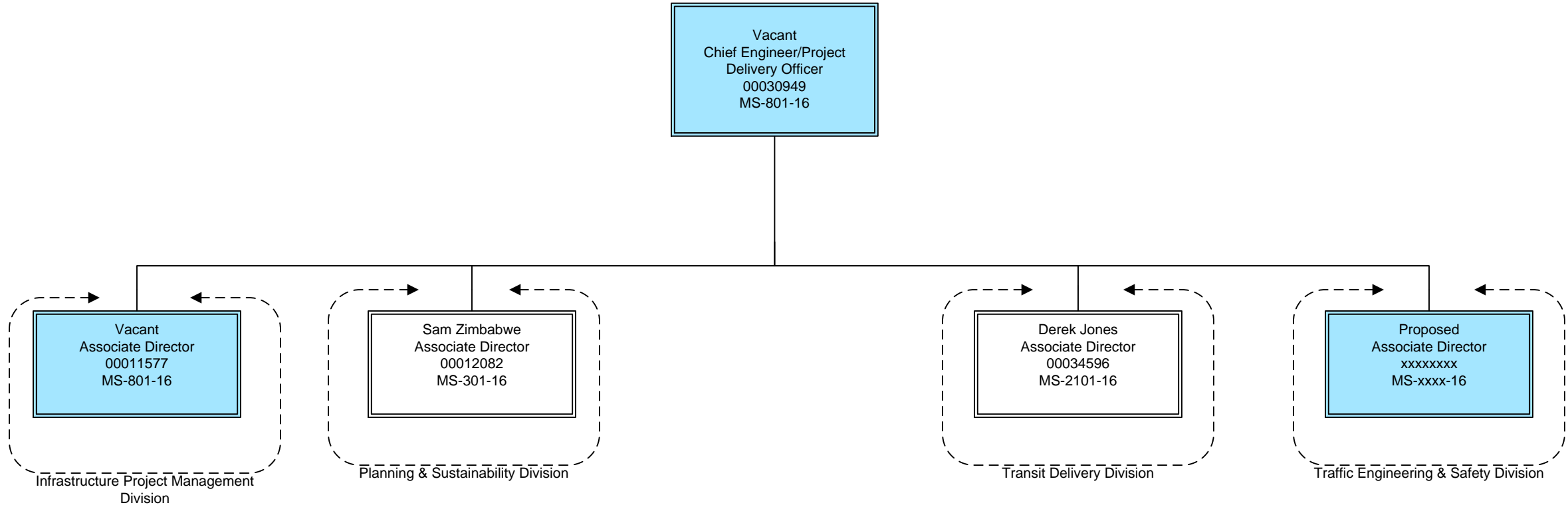

Approved by: Leif A. Dormsjo, Director

Signature: _____ Date: _____

District Department Of Transportation
Project Delivery Administration
Office of Chief Engineer/Project Delivery Officer
Infrastructure Project Management Division
Office of the Associate Director

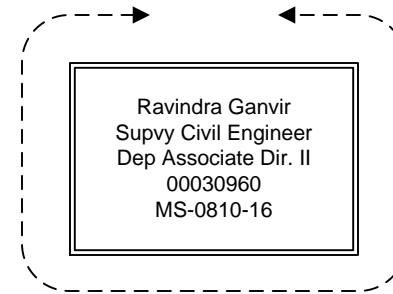
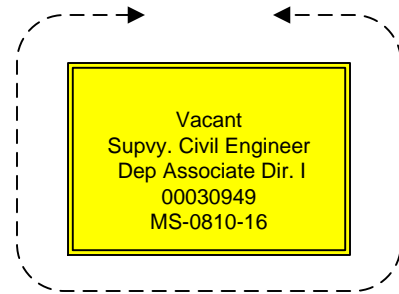
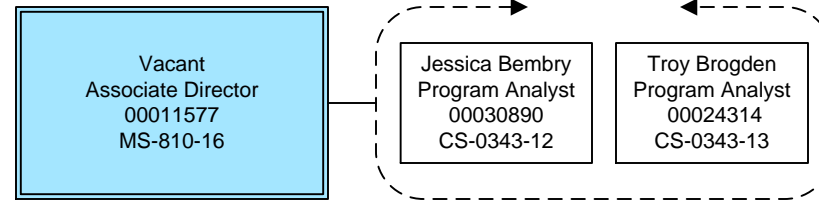

Approved by: Leif A. Dormsjo, Director

Signature: ----- Date: -----

District Department Of Transportation
Project Delivery Administration
Office of Chief Engineer/Project Delivery Officer
Infrastructure Project Management Division
Design & Construction Management

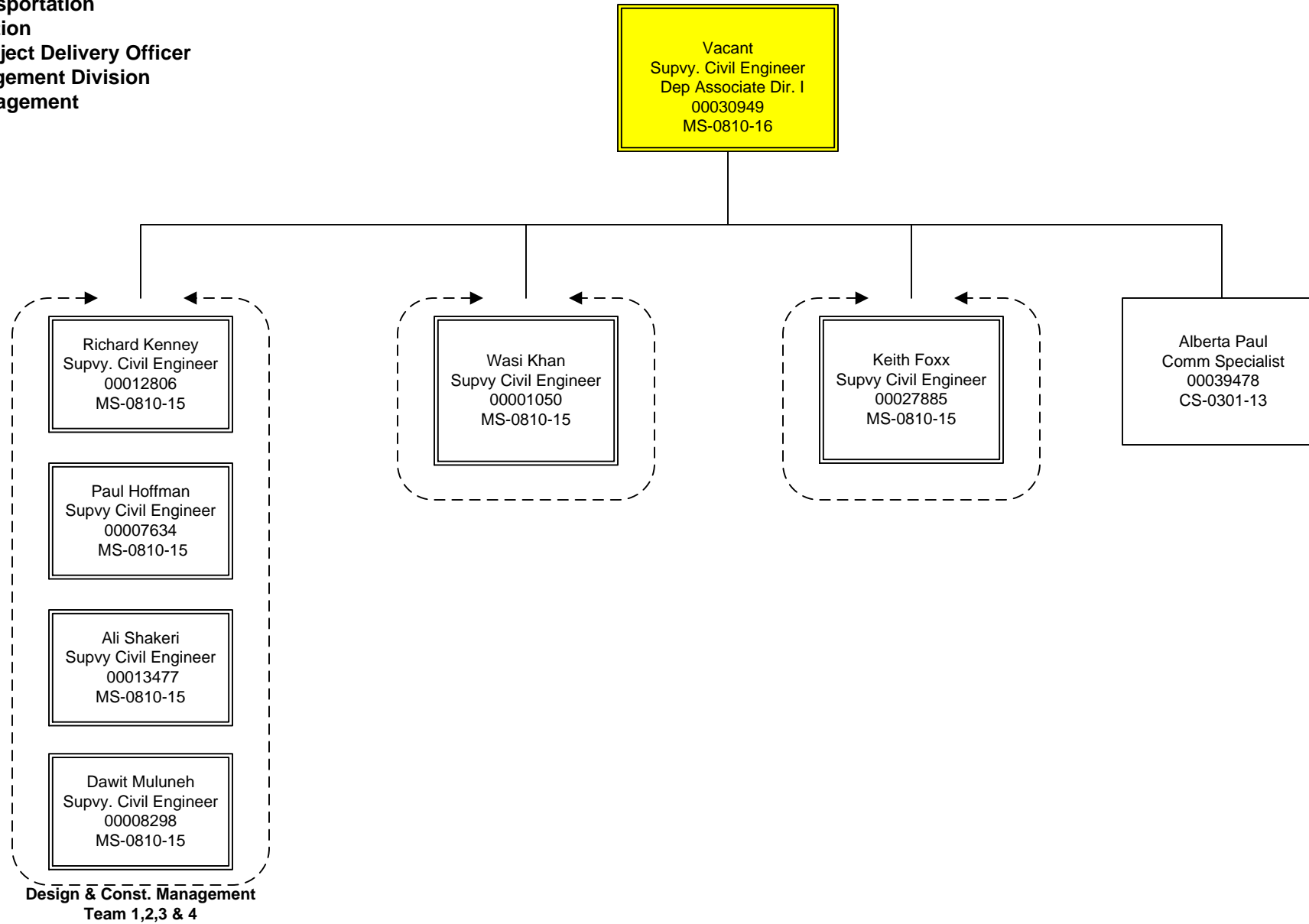

Approved by: Leif A. Dormsjo, Director

Signature: ----- Date: -----

District Department Of Transportation
Project Delivery Administration
Office of Chief Engineer/Project Delivery Officer
Infrastructure Project Management Division
Design & Construction Team 1

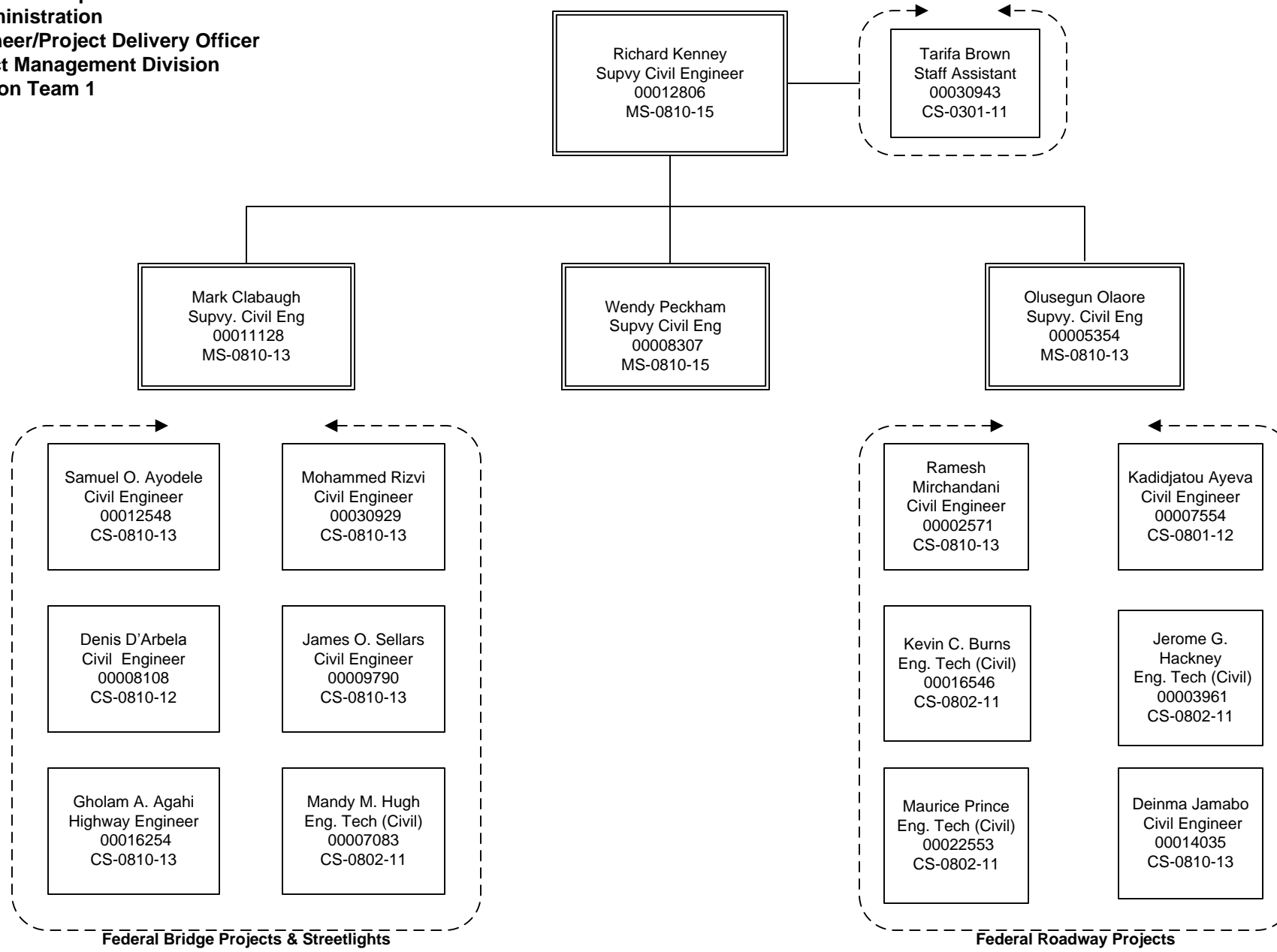

Approved by: Leif A. Dormsjo, Director

Signature: ----- Date: -----

District Department Of Transportation
Project Delivery Administration
Office of Chief Engineer/Project Delivery Officer
Infrastructure Project Management Division
Design & Construction Team 2

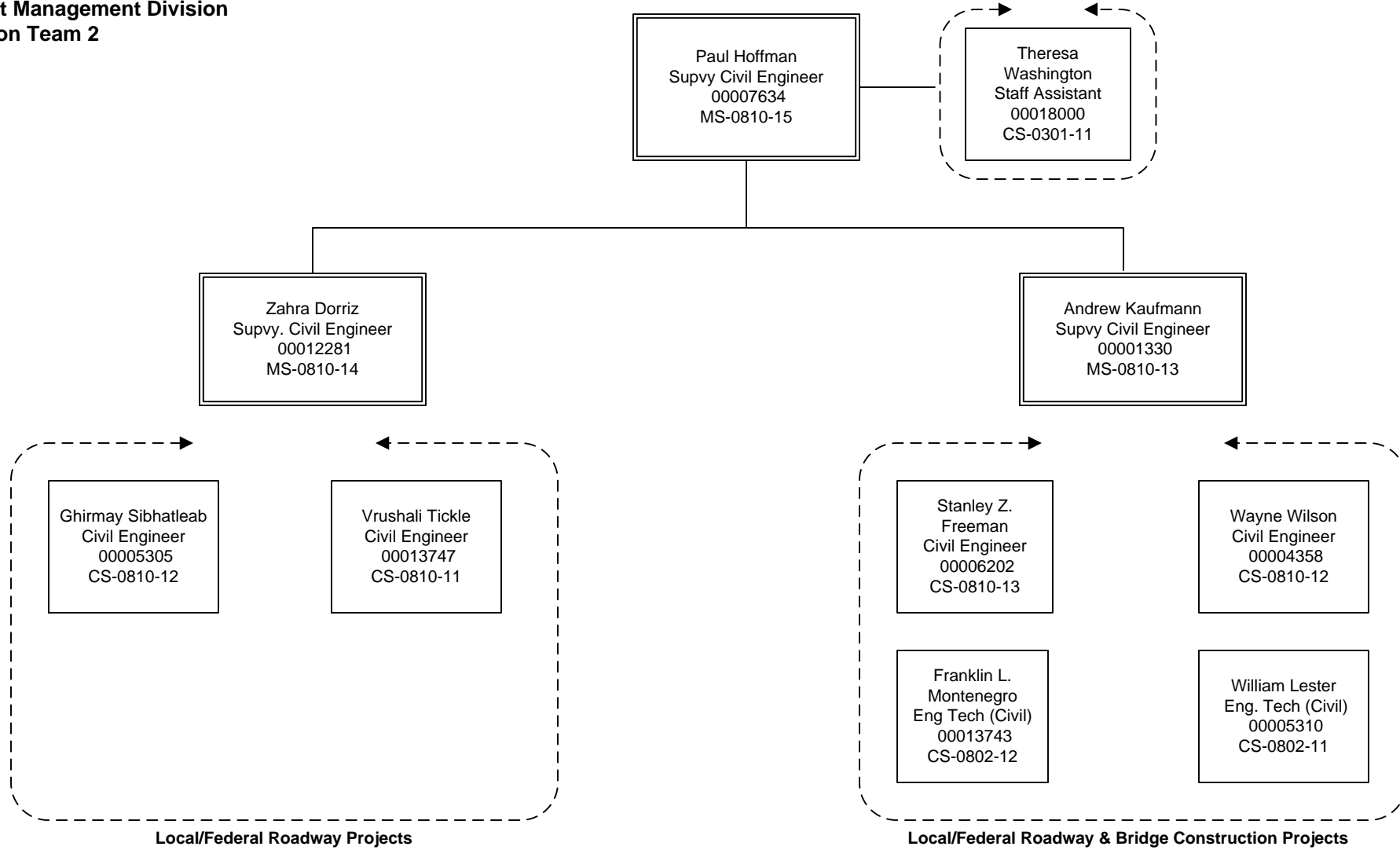

Approved by: Leif A. Dormsjo, Director

Signature: ----- Date: -----

District Department Of Transportation
 Project Delivery Administration
 Office of Chief Engineer/Project Delivery Officer
 Infrastructure Project Management Division
 Design & Construction Team 3

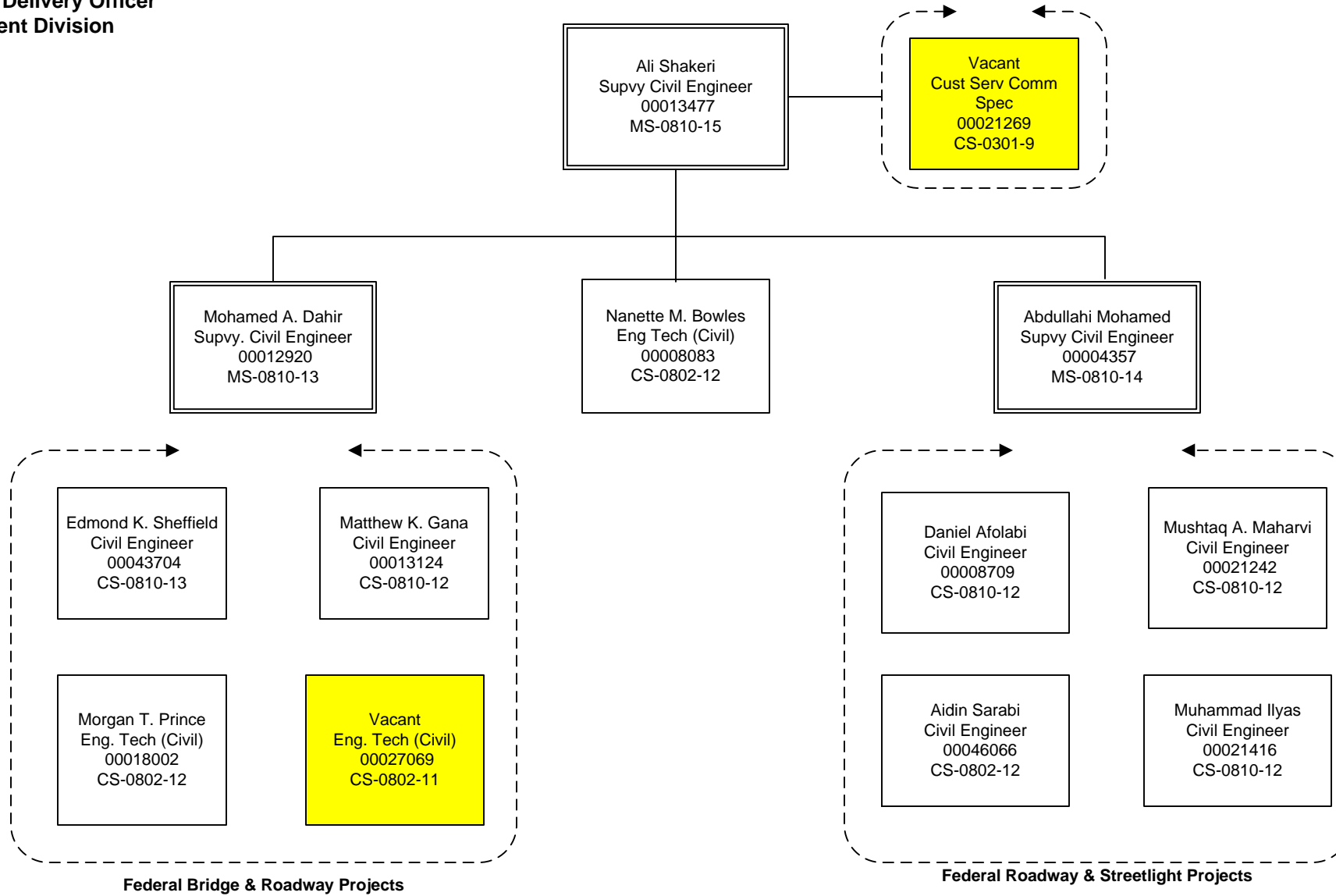

Approved by: Leif A. Dormsjo, Director

Signature: ----- Date: -----

District Department Of Transportation
Project Delivery Administration
Office of Chief Engineer/Project Delivery Officer
Infrastructure Project Management Division
Design & Construction Team 4

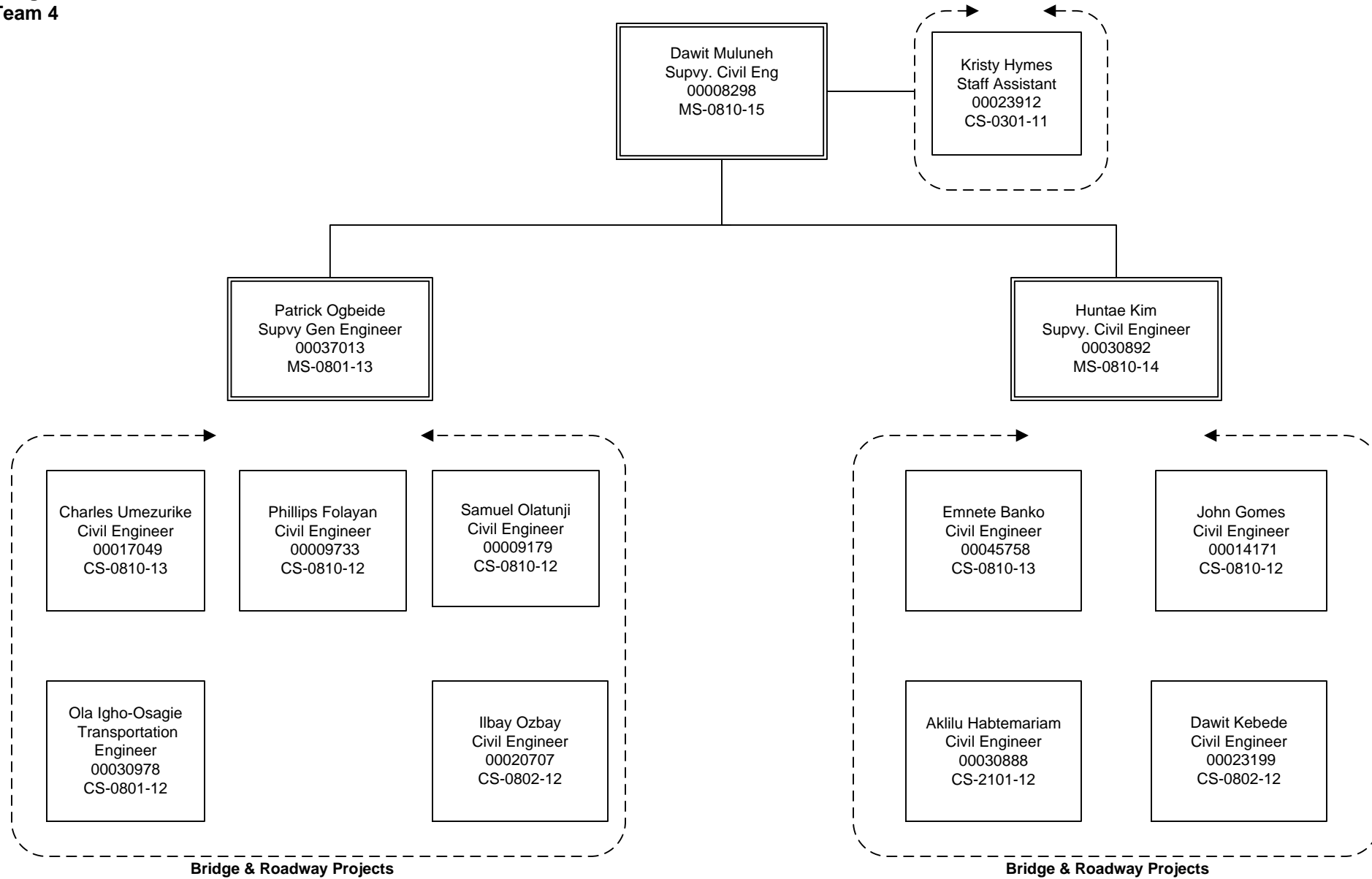

Approved by: Leif A. Dormsjo, Director

Signature: ----- Date: -----

**District Department Of Transportation
 Project Delivery Administration
 Office of Chief Engineer/Project Delivery Officer
 Infrastructure Project Management Division
 Quality Assurance & Quality Control**

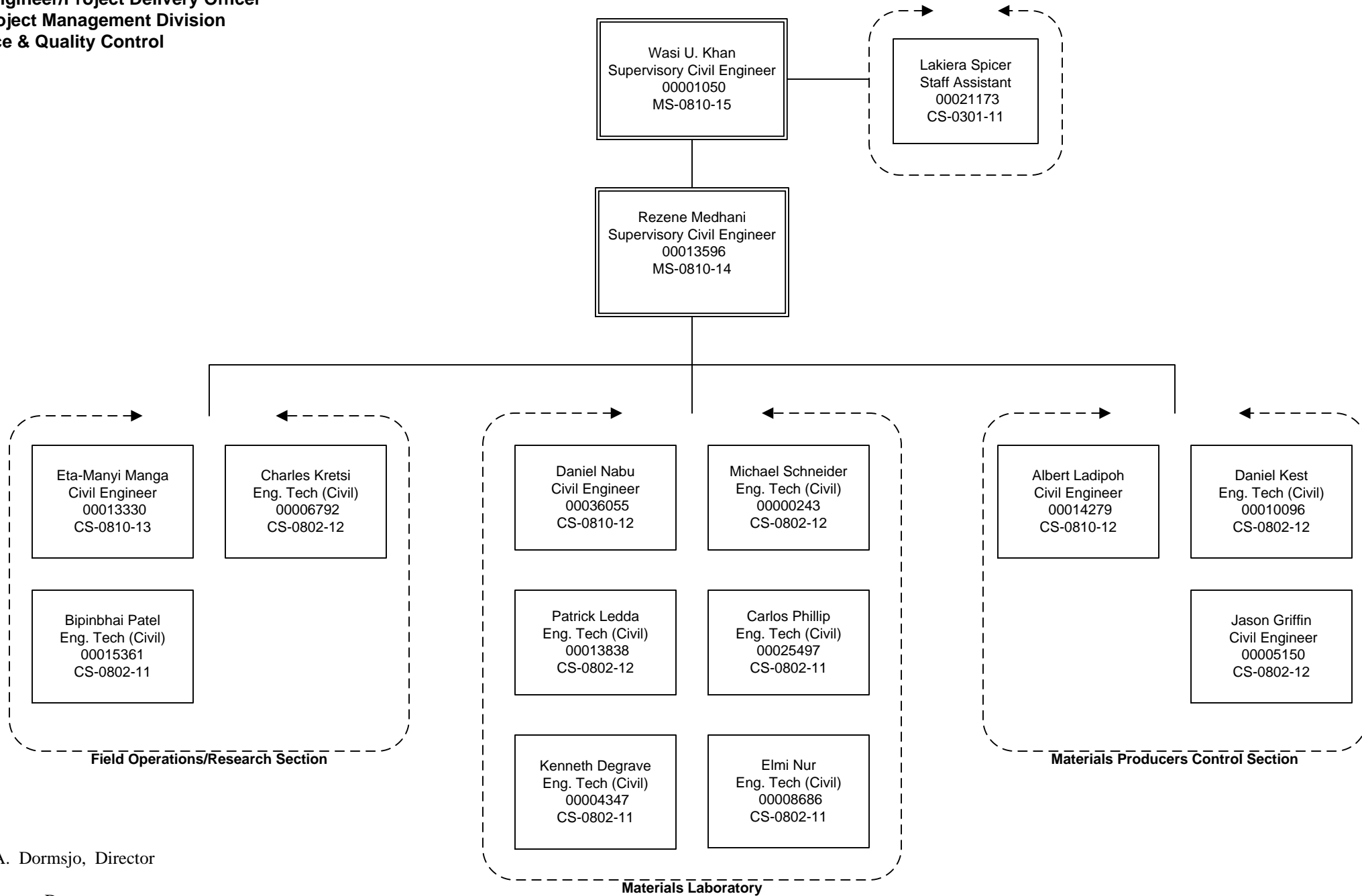

Approved by: Leif A. Dormsjo, Director

Signature: ----- Date: -----

District Department Of Transportation
Project Delivery Administration
Office of Chief Engineer/Project Delivery Officer
Infrastructure Project Management Division
DC PLUG Program

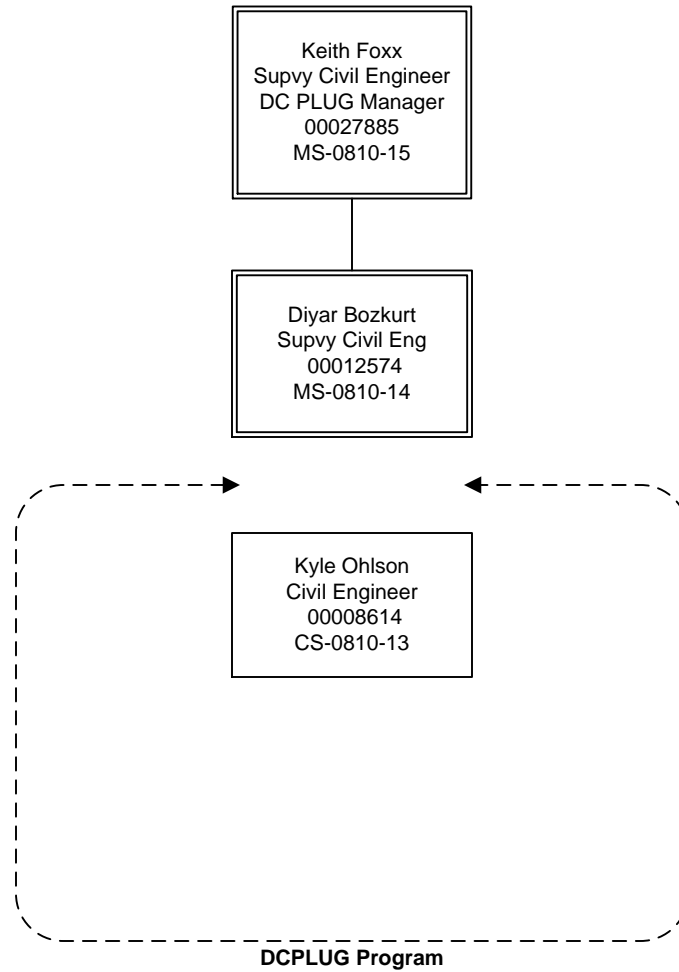

Approved by: Leif A. Dormsjo, Director

Signature: ----- Date: -----

District Department Of Transportation
 Project Delivery Administration
 Office of Chief Engineer/Project Delivery Officer
 Infrastructure Project Management Division
 Stormwater Branch

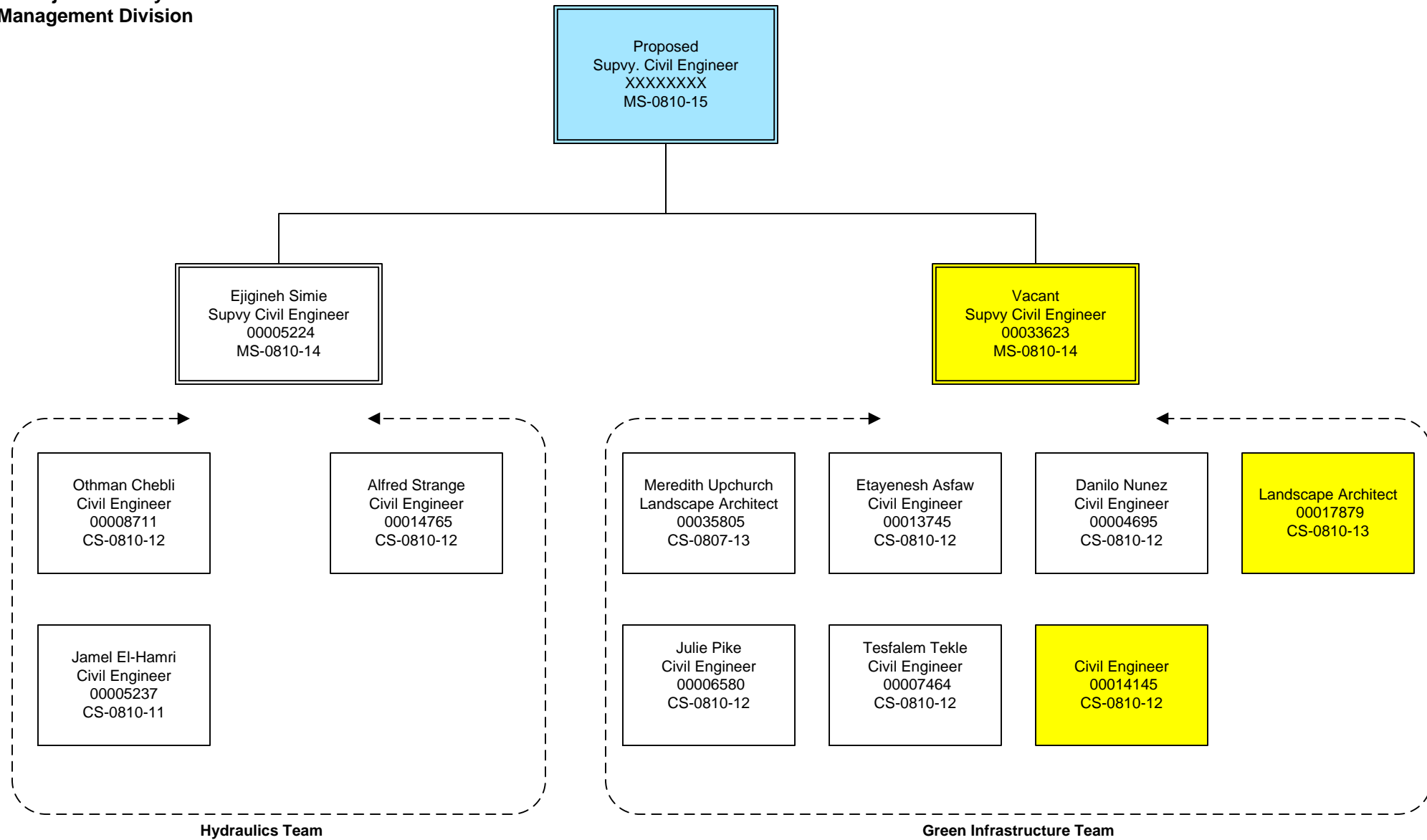

Approved by: Leif A. Dormsjo, Director

Signature: ----- Date: -----

**District Department Of Transportation
 Project Delivery Administration
 Office of Chief Engineer/Project Delivery Officer
 Infrastructure Project Management Division
 Anacostia Waterfront Initiative/Mega Projects**

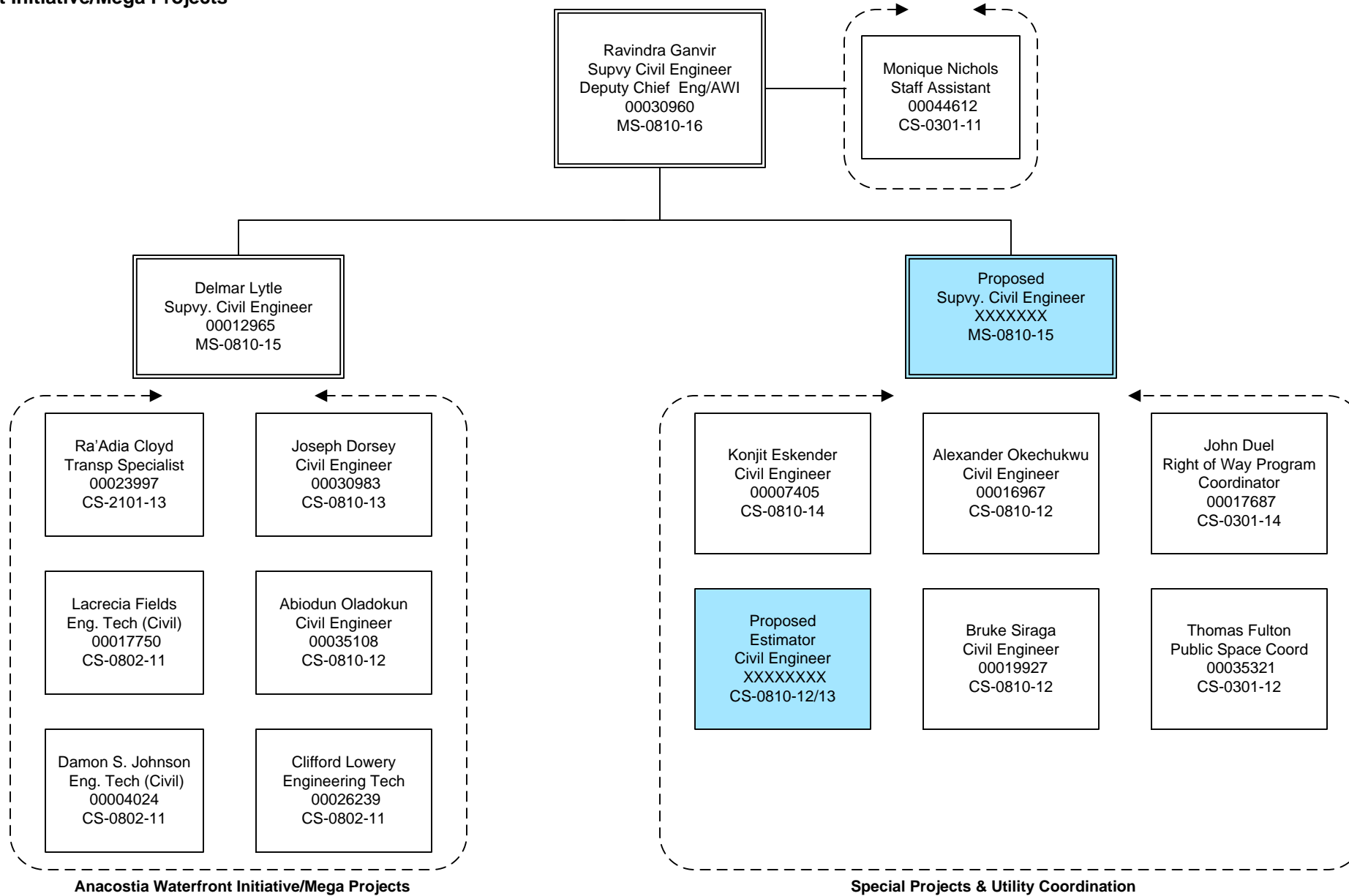

Approved by: Leif A. Dormsjo, Director

Signature: ----- Date: -----

District Department of Transportation
Project Delivery Administration
Office of the Chief Engineer/Project Delivery
Officer
Planning & Sustainability Division

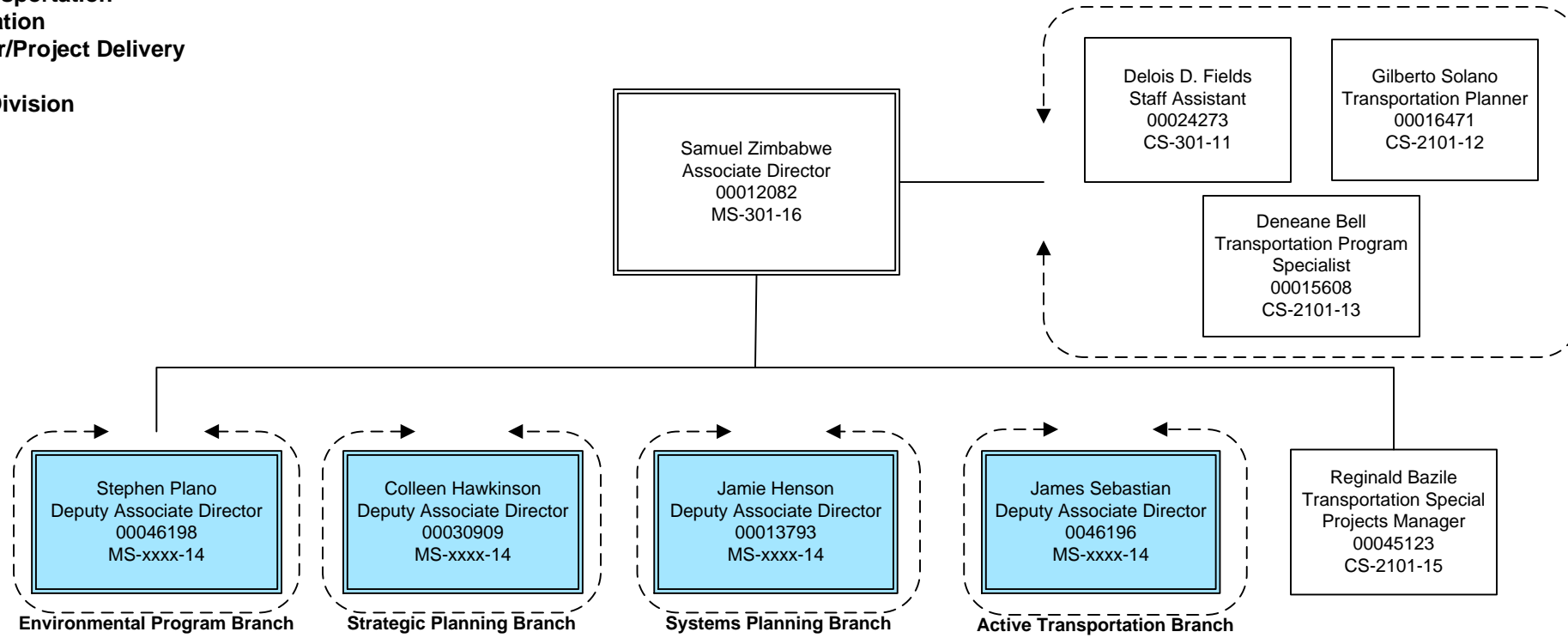

Approved By: Leif A. Dormsjo, Director

Signature: _____ Date: _____

District Department of Transportation
Project Delivery Administration
Office of the Chief Engineer/Project Delivery
Officer
Planning & Sustainability Division

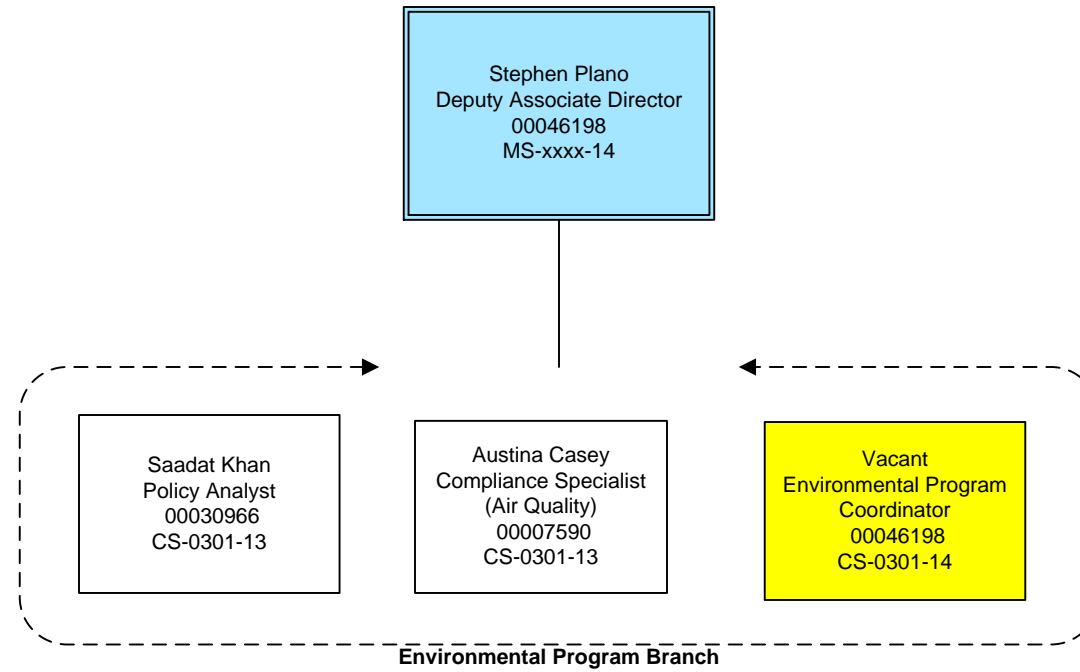

Approved By: Leif A. Dormsjo, Director

Signature: _____ Date: _____

District Department of Transportation
Project Delivery Administration
Office of the Chief Engineer/Project Delivery
Officer
Planning & Sustainability Division

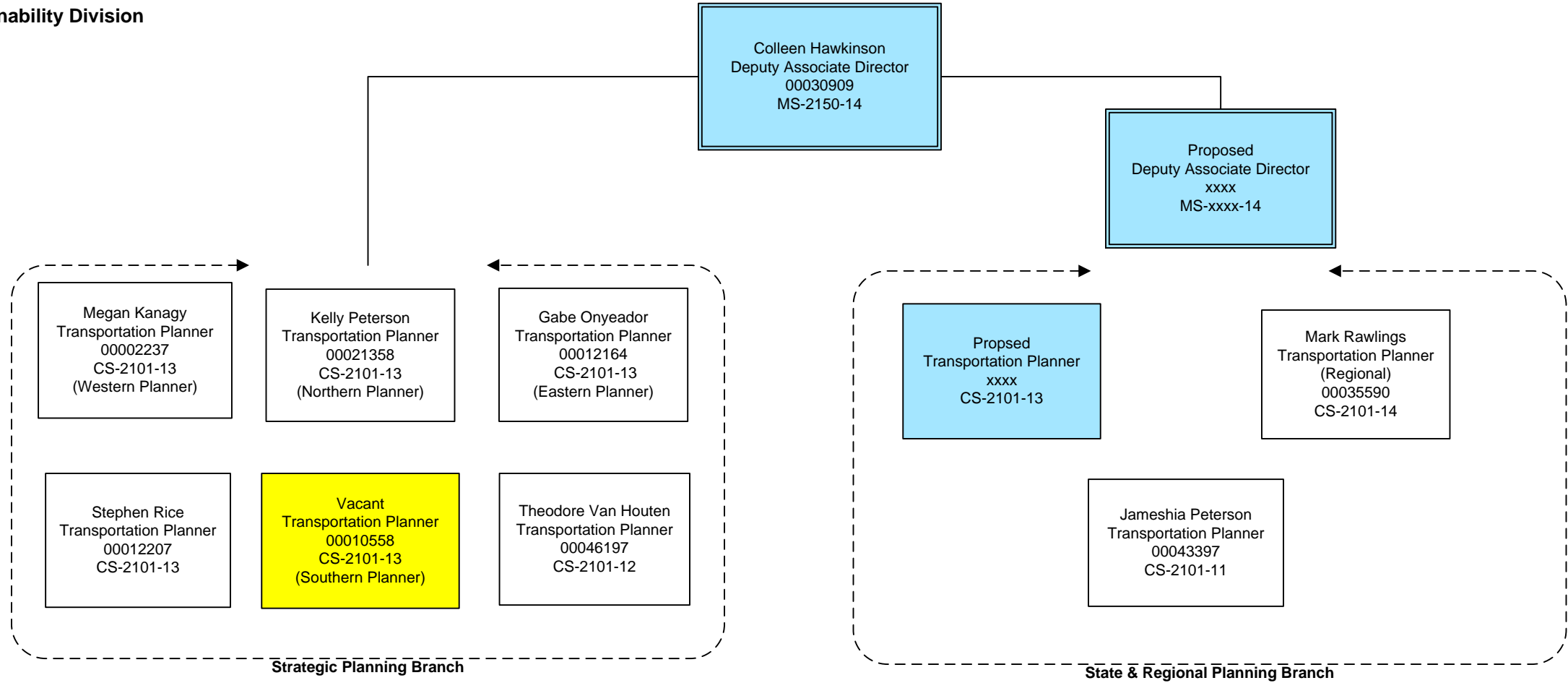

Approved By: Leif A. Dormsjo, Director

Signature: _____ Date: _____

District Department of Transportation
Project Delivery Administration
Office of the Chief Engineer/Project Delivery
Officer
Planning & Sustainability Division

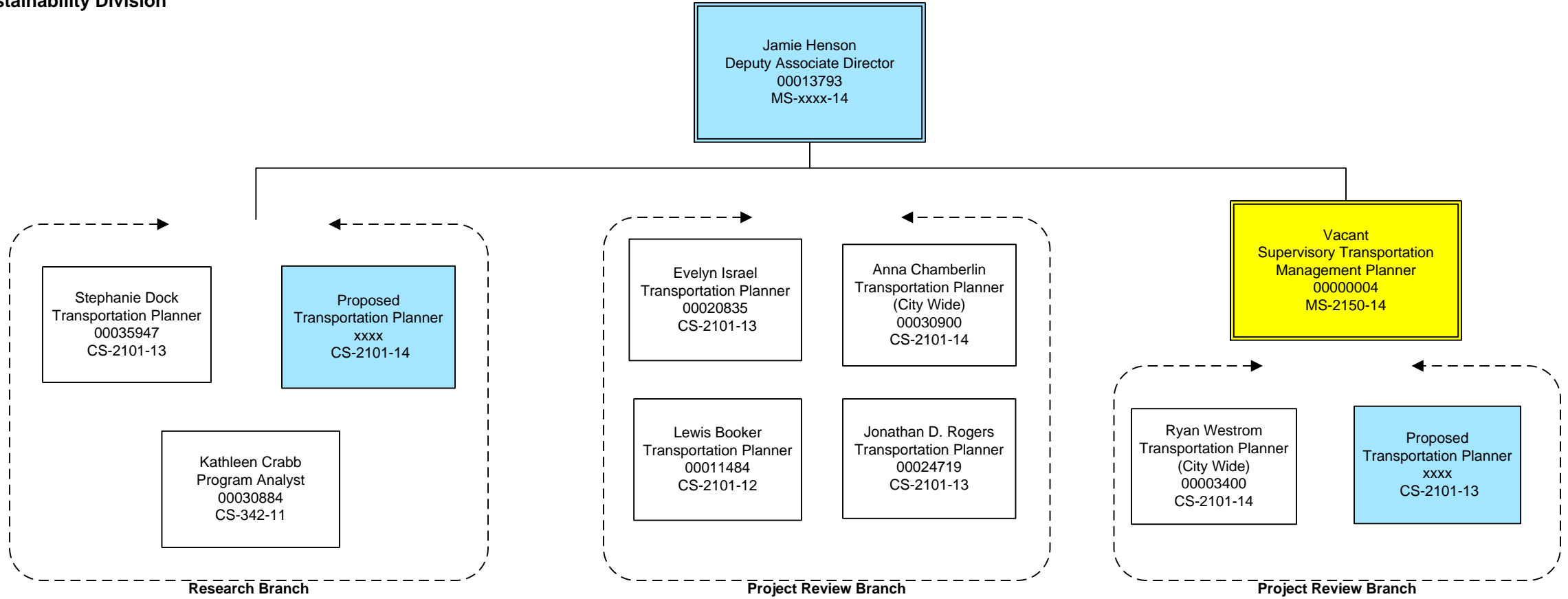

Approved By: Leif A. Dormsjo, Director

Signature: _____ Date: _____

District Department of Transportation
Project Delivery Administration
Office of the Chief Engineer/Project Delivery
Officer
Planning & Sustainability Division

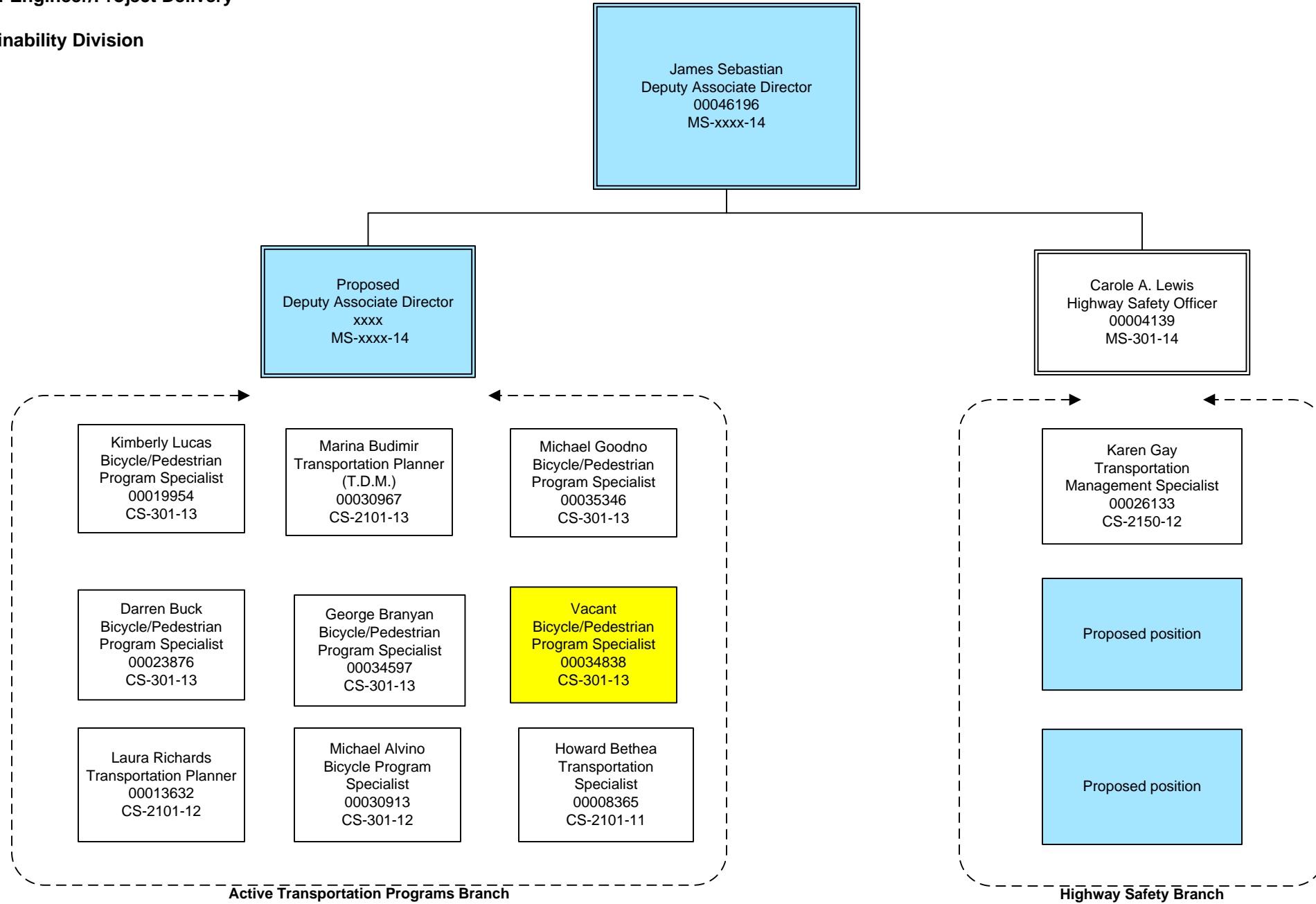

Approved By: Leif A. Dormsjo, Director

Signature: _____ Date: _____

District Department of Transportation
Project Delivery Administration
Office of the Chief Engineer/Project Delivery
Officer
Transit Delivery Division

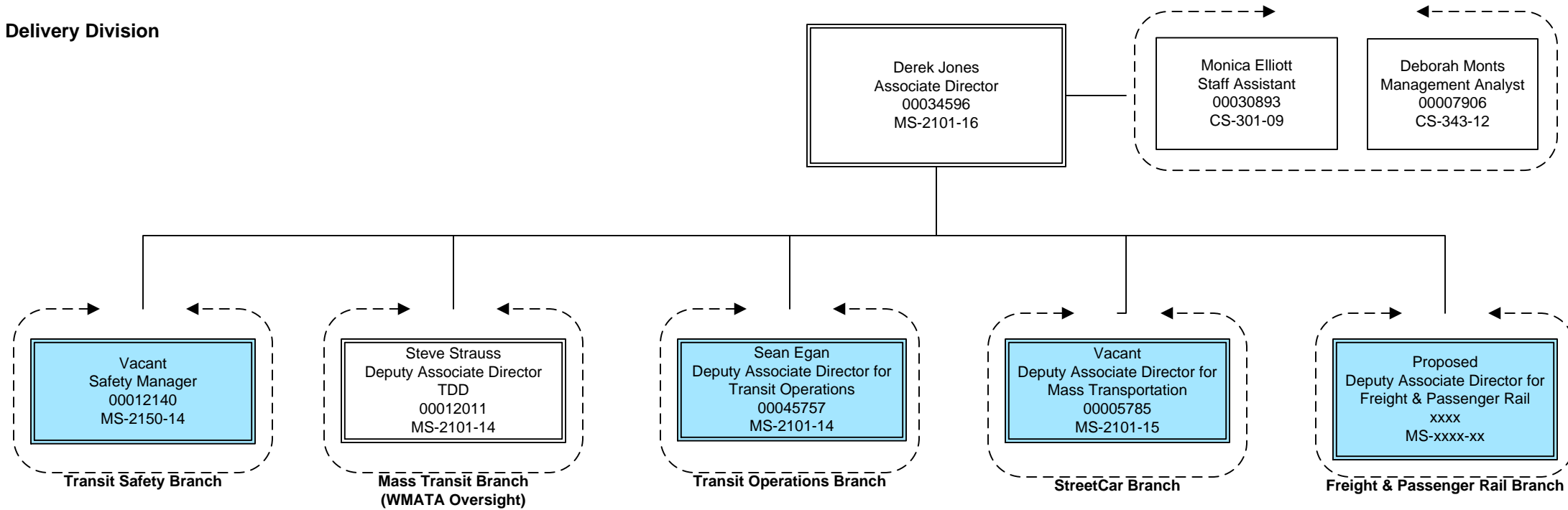

Approved By: Leif A. Dormsjo, Director

Signature: _____ Date: _____

District Department of Transportation
Project Delivery Administration
Office of the Chief Engineer/Project Delivery
Officer
Transit Delivery Division

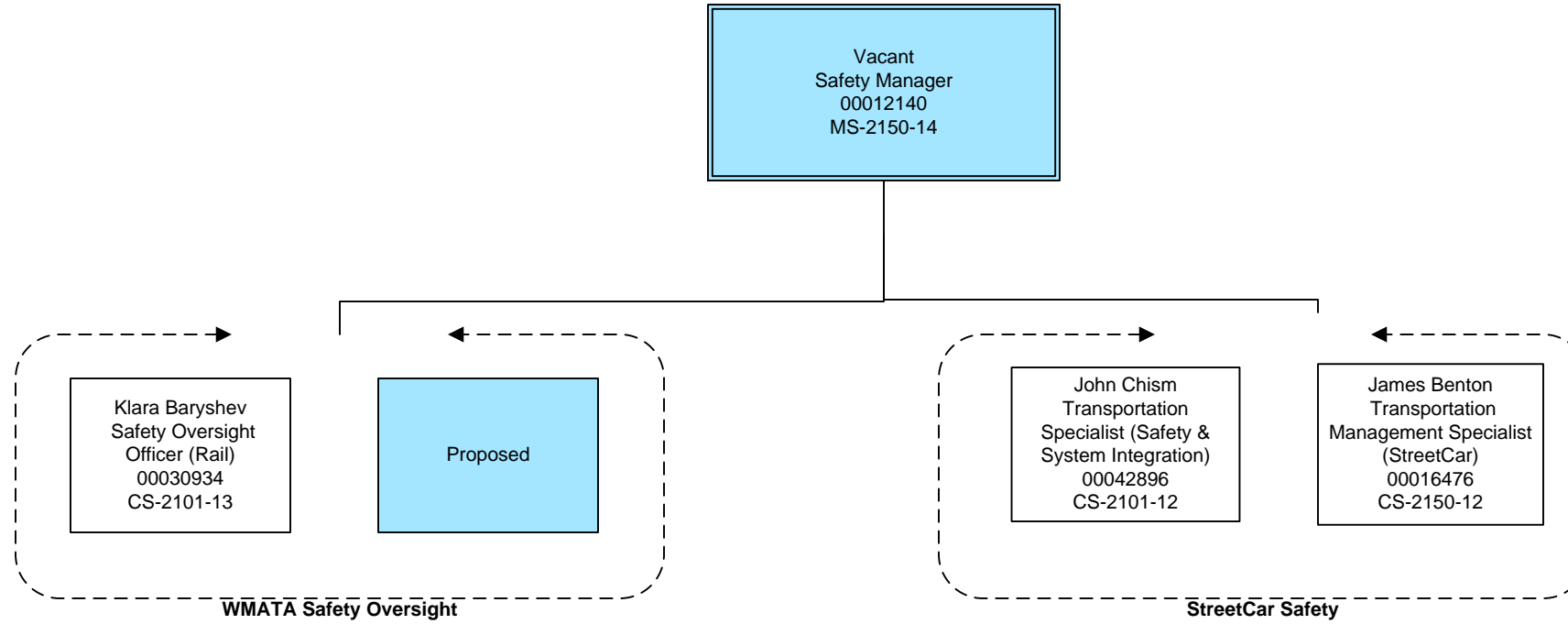

Approved By: Leif A. Dormsjo, Director

Signature: _____ Date: _____

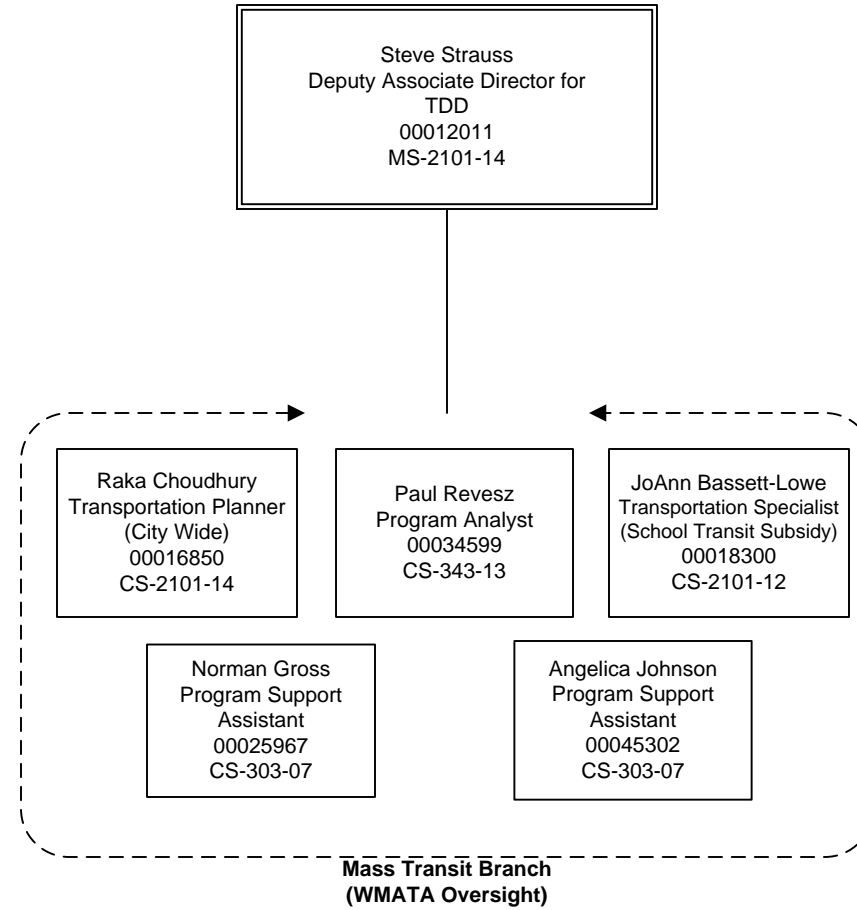

Approved By: Leif A. Dormsjo, Director

Signature: _____ Date: _____

District Department of Transportation
Project Delivery Administration
Office of the Chief Engineer/Project Delivery
Officer
Transit Delivery Division

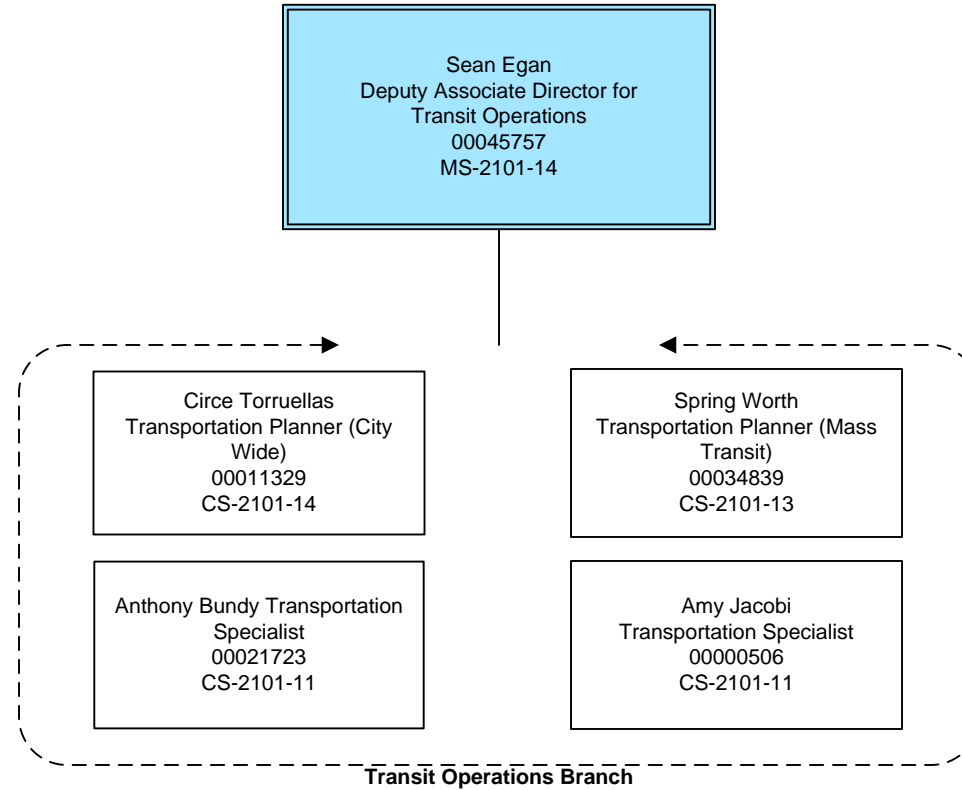

Approved By: Leif A. Dormsjo, Director

Signature: _____ Date: _____

District Department of Transportation
Project Delivery Administration
Office of the Chief Engineer/Project Delivery
Officer
Transit Delivery Division

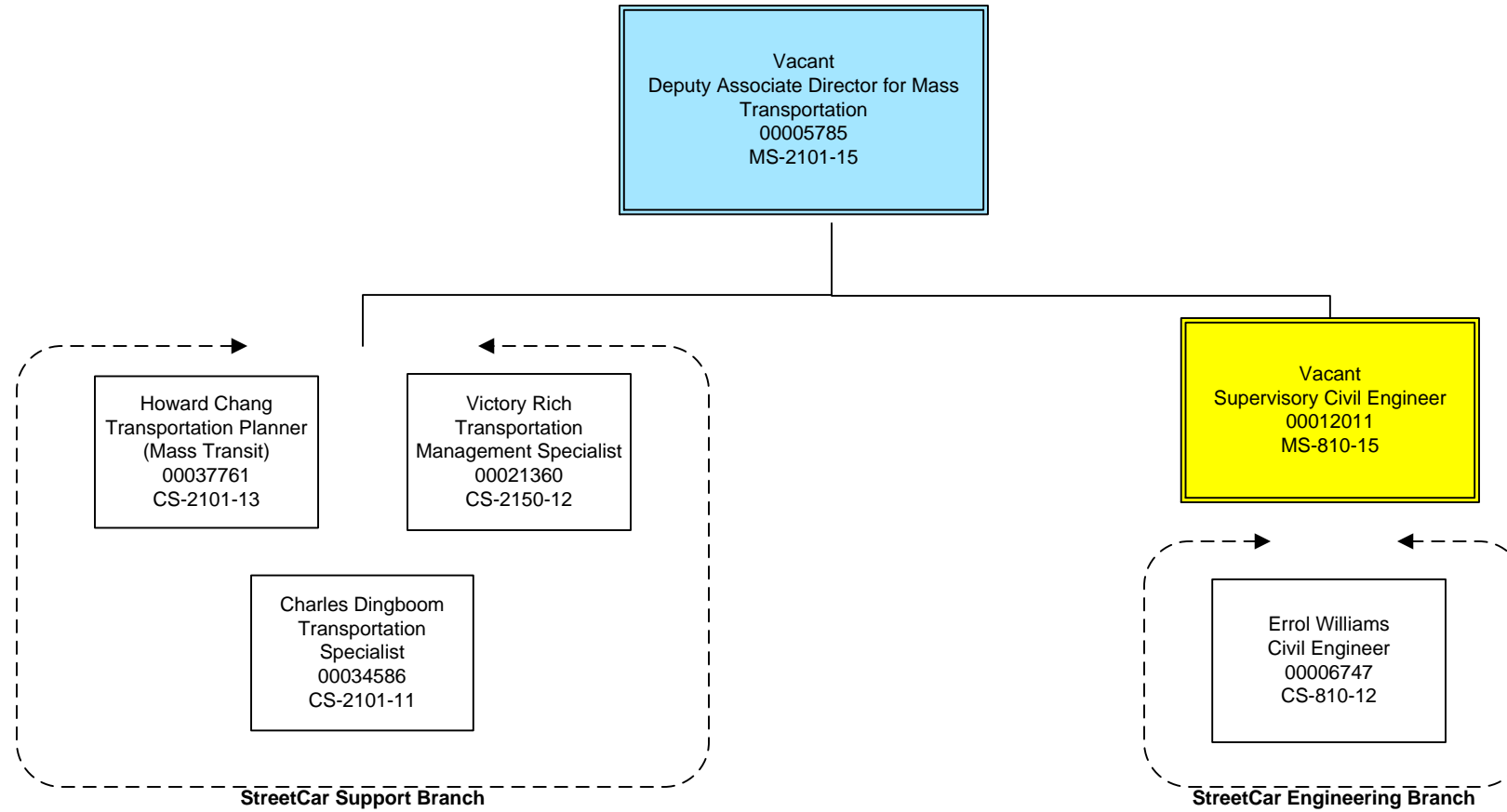

Approved By: Leif A. Dormsjo, Director

Signature: _____ Date: _____

District Department of Transportation
Project Delivery Administration
Office of the Chief Engineer/Project Delivery
Officer
Transit Delivery Division

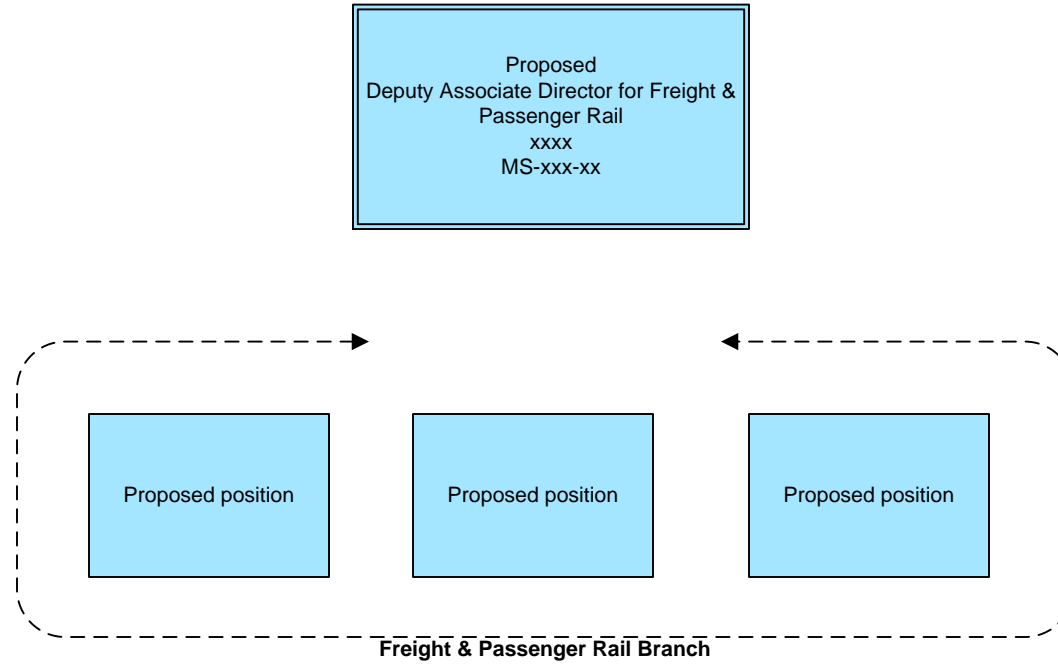

Approved By: Leif A. Dormsjo, Director

Signature: _____ Date: _____

**District Department of Transportation
Project Delivery Administration
Office of the Chief Engineer/Project Development
Officer (CEPDO)
Traffic Engineering and Safety Division**

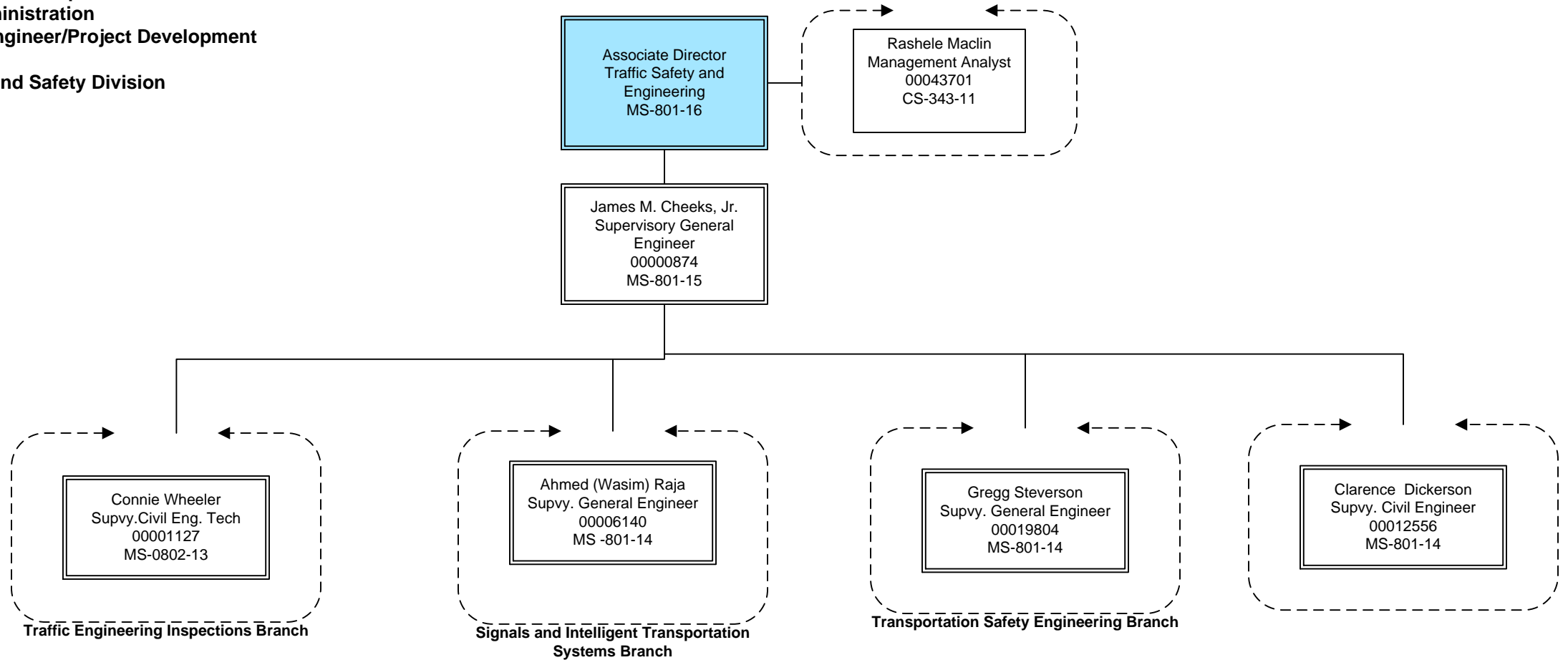

Approved by: Leif A. Dormsjo, Director

Signature: _____ Date: _____

**District Department of Transportation
Project Delivery Administration
Office of the Chief Engineer/Project Development
Officer (CEPDO)
Traffic Engineering and Safety Division**

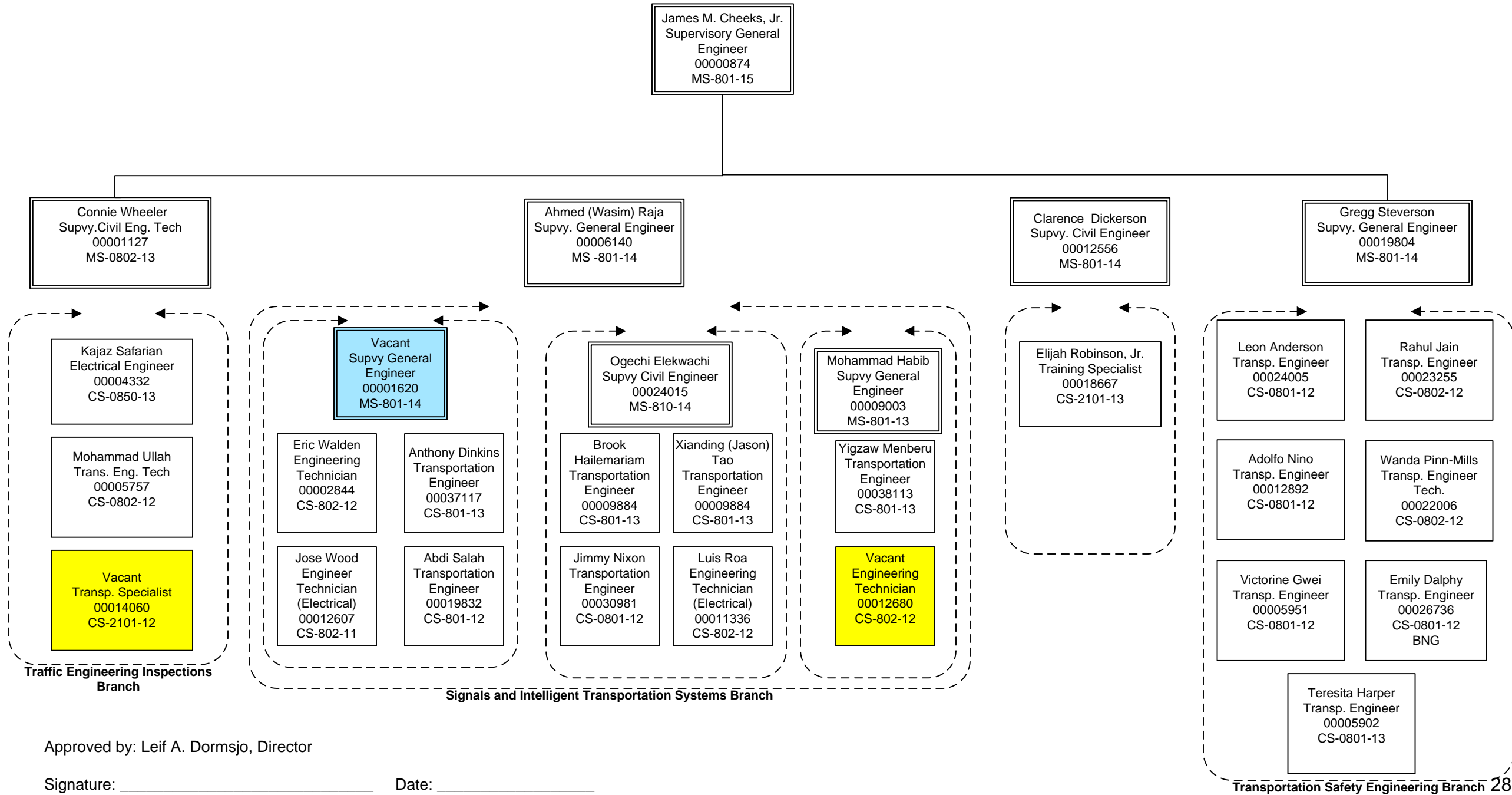

Approved by: Leif A. Dormsjo, Director

Signature: _____

Date: _____

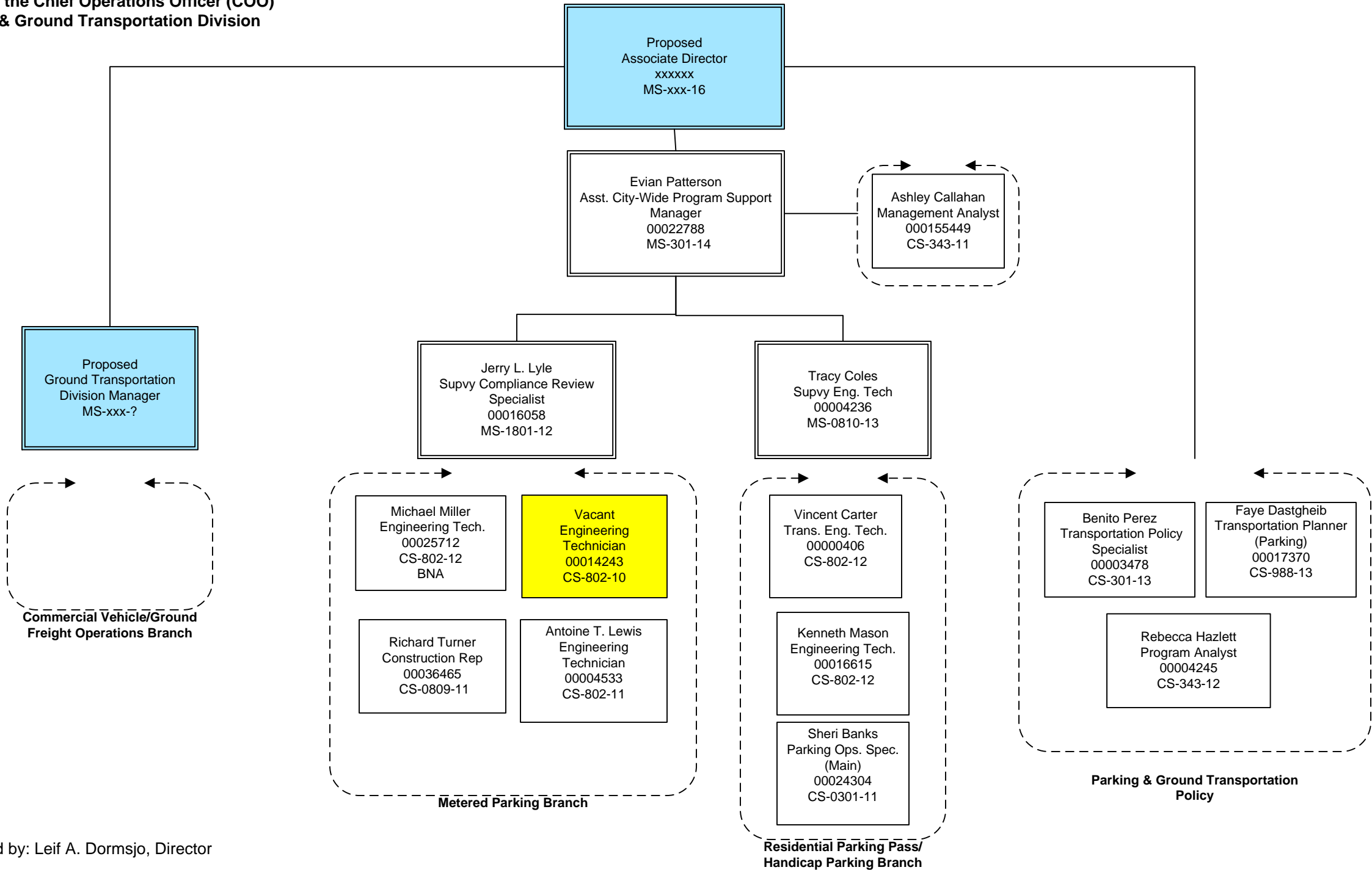

Approved by: Leif A. Dormsjo, Director

Signature: _____

Date: _____

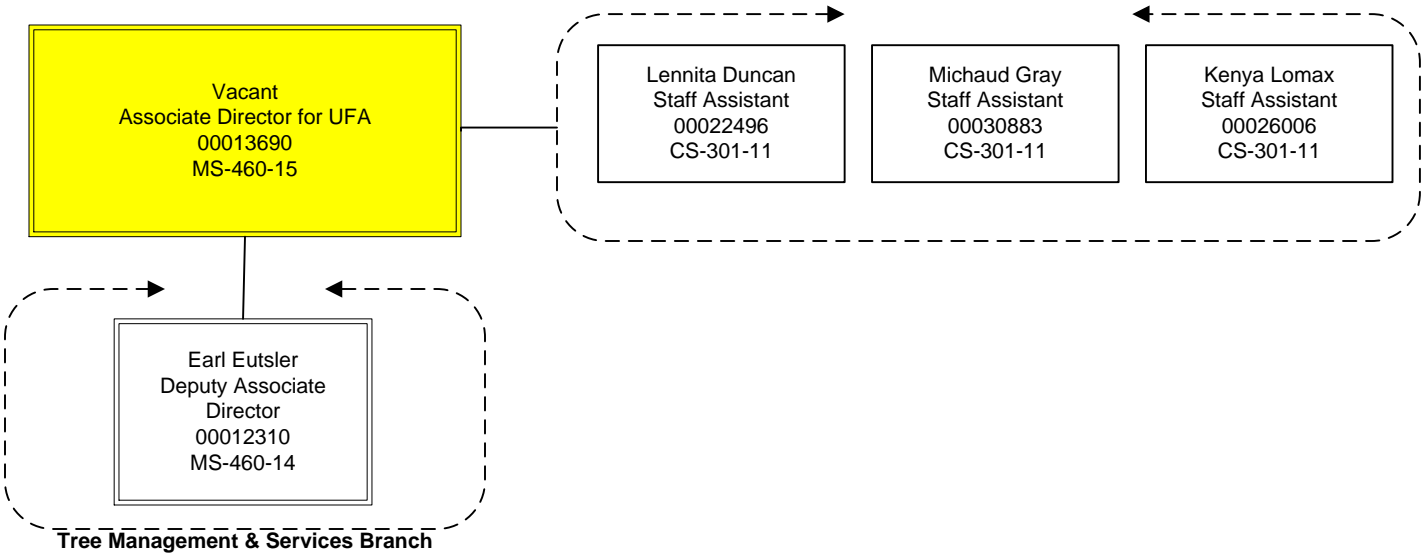

Approved by: Leif A. Dormsjo, Director

Signature: _____ Date: _____

**District Department of Transportation
 Operations Administration
 Office of the Chief Operations Officer
 Urban Forestry Division**

Proposed

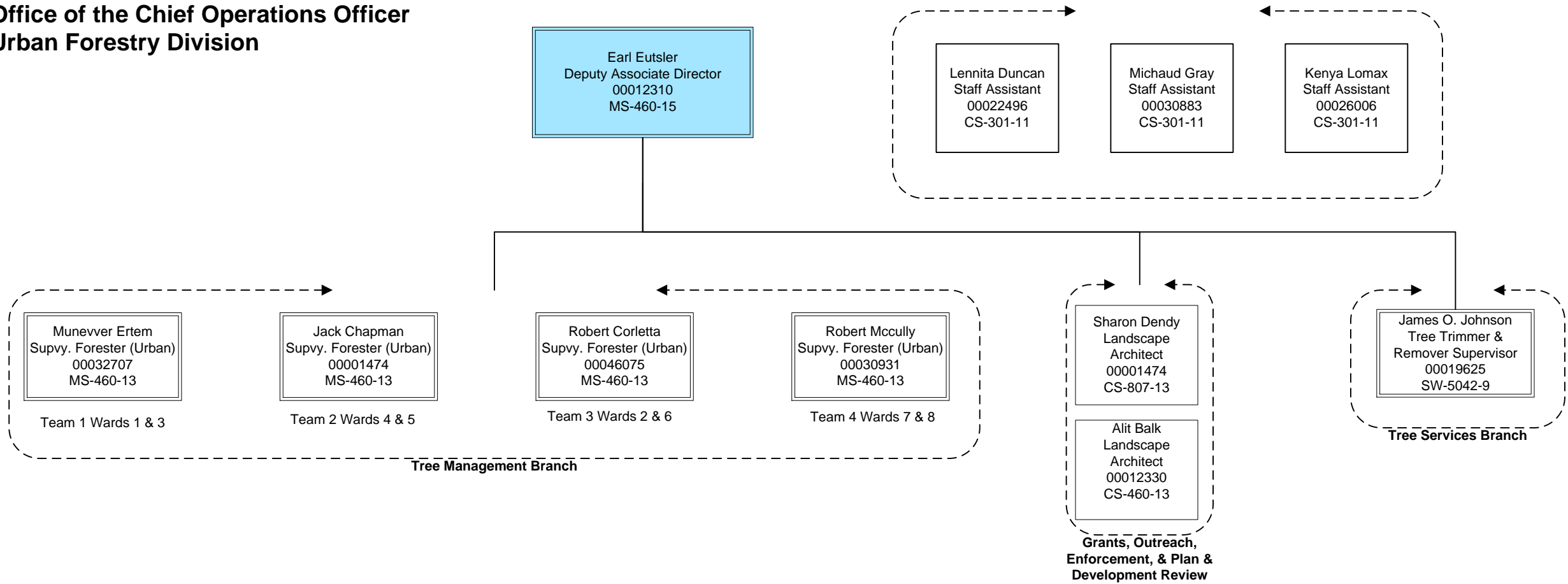

Approved by: Leif A. Dormsjo, Director

Signature: _____ Date: _____

**District Department of Transportation
 Operations Administration
 Office of the Chief Operations Officer
 Urban Forestry Division**

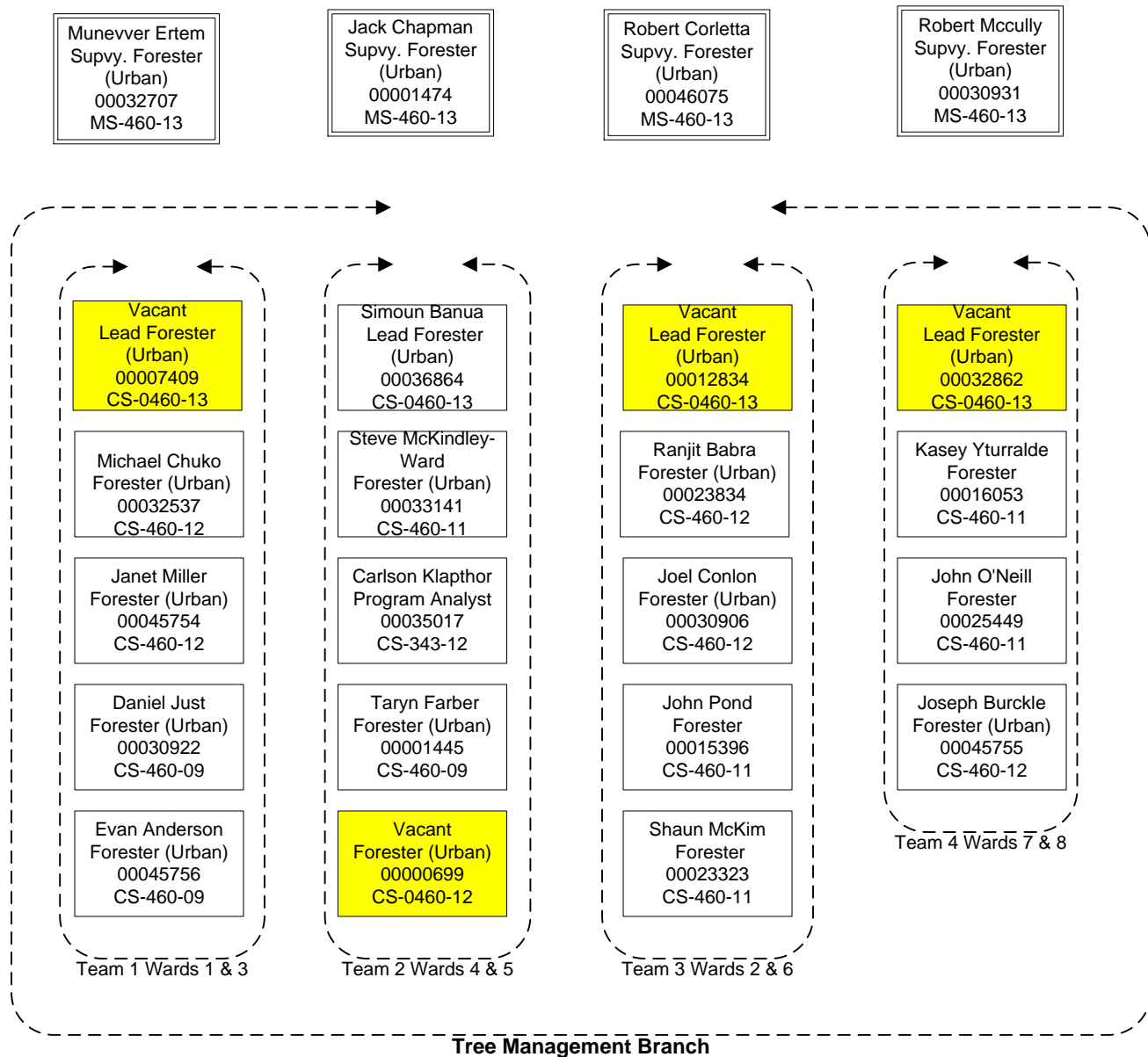

Approved by: Leif A. Dormsjo, Director

Signature: _____ Date: _____

Tree Management Branch

**District Department of Transportation
Operations Administration
Office of the Chief Operations Officer
Urban Forestry Division**

Proposed

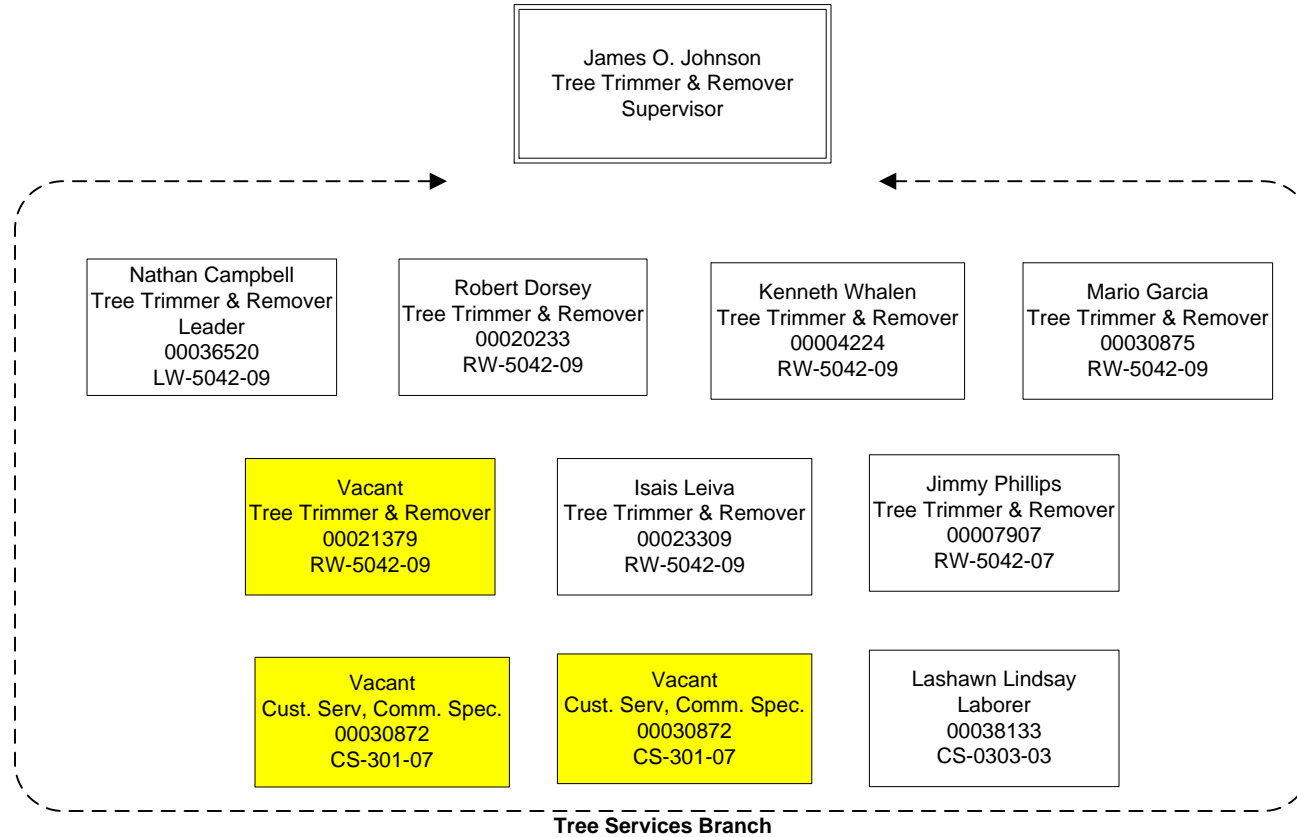

Approved by: Leif A. Dormsjo, Director

Signature: _____ Date: _____

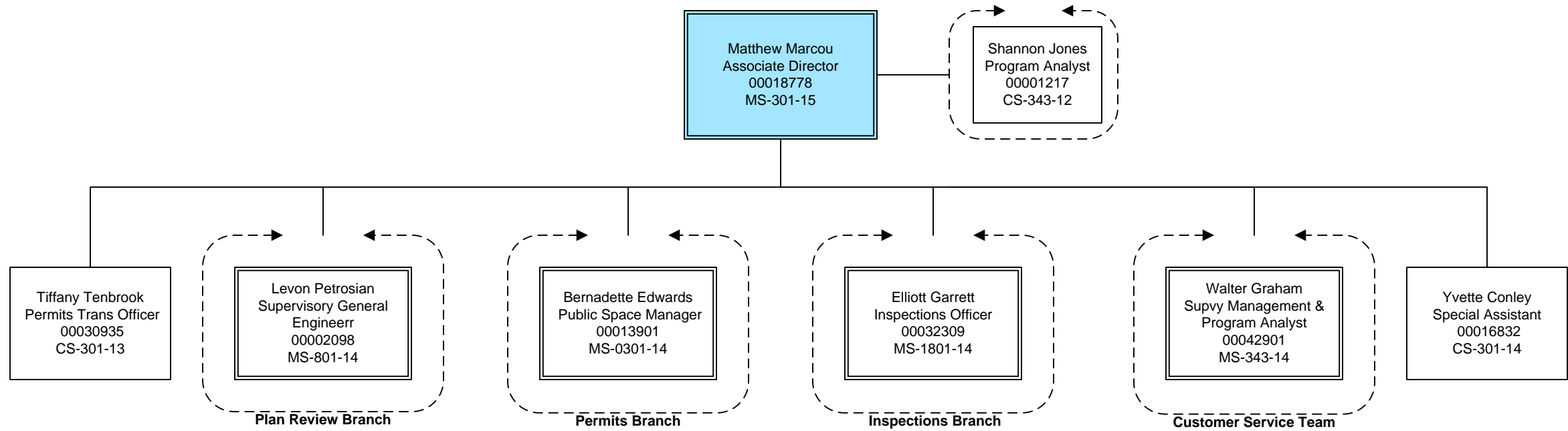

Approved by: Leif A. Dormsjo, Director

Signature: ----- Date: -----

District Department Of Transportation
Operations Administration
Office of the Chief Operations Officer
Public Space Regulation Division
Plan Review Branch

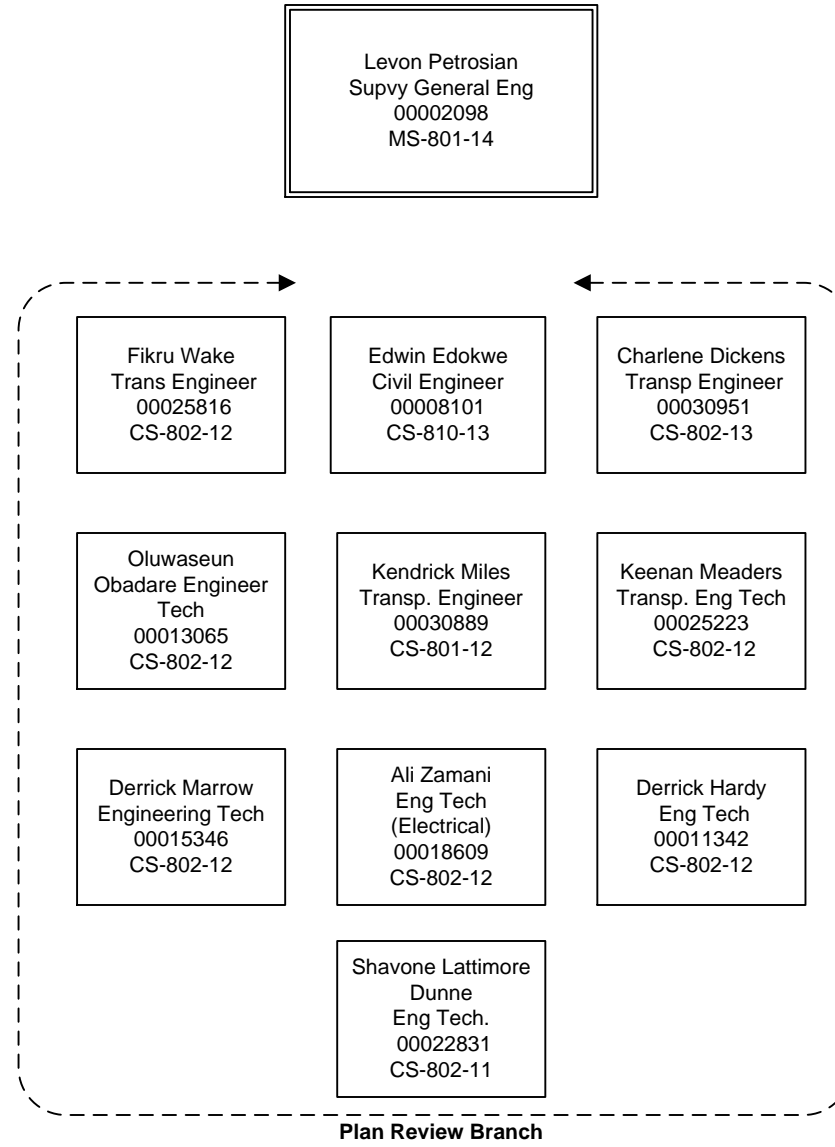

Approved by: Leif A. Dormsjo, Director

Signature: ----- Date: -----

District Department Of Transportation
 Operations Administration
 Office of the Chief Operations Officer
 Public Space Regulation Division
 Permits Branch

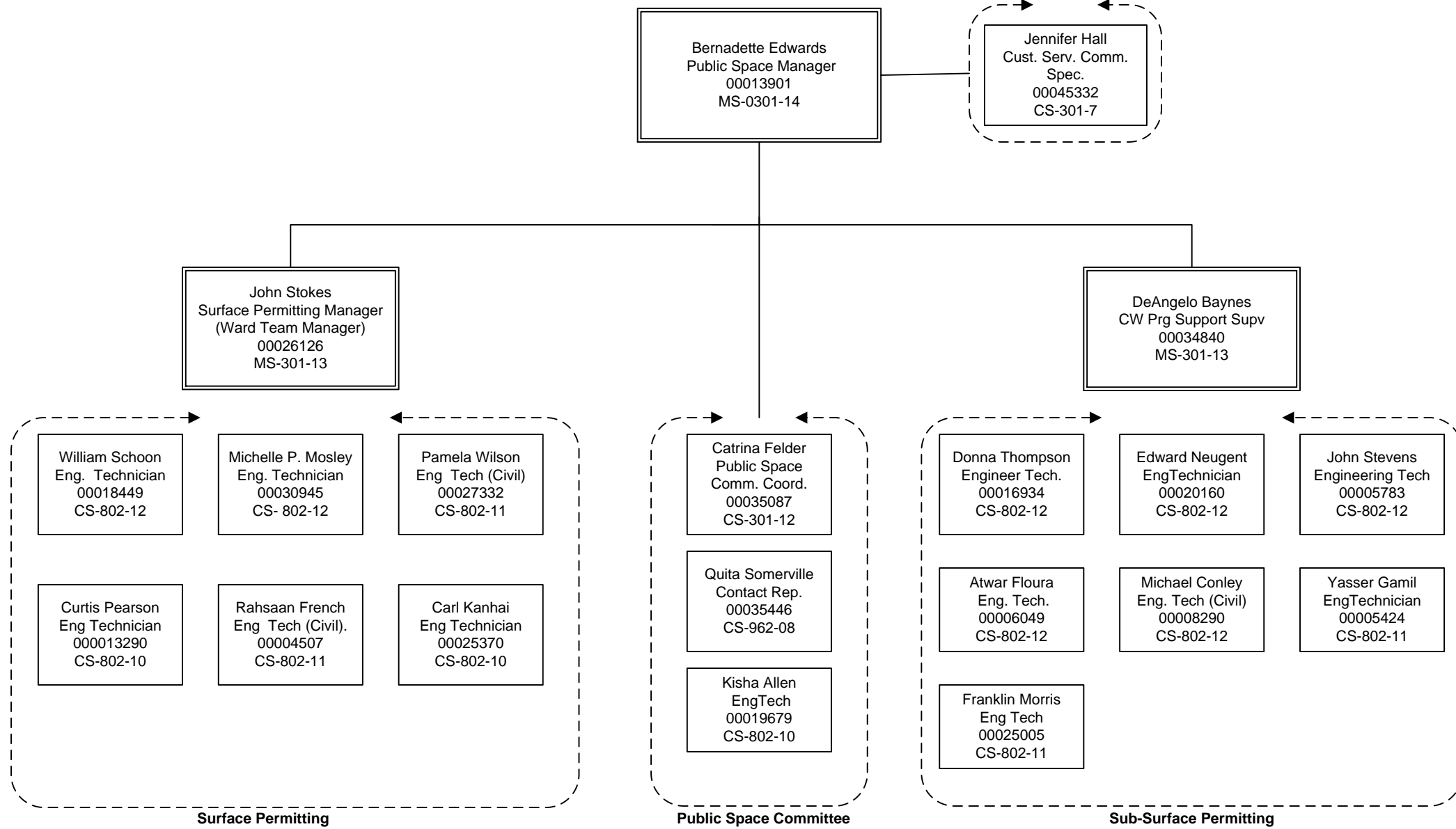

Approved by: Leif A. Dormsjo, Director

Signature: ----- Date: -----

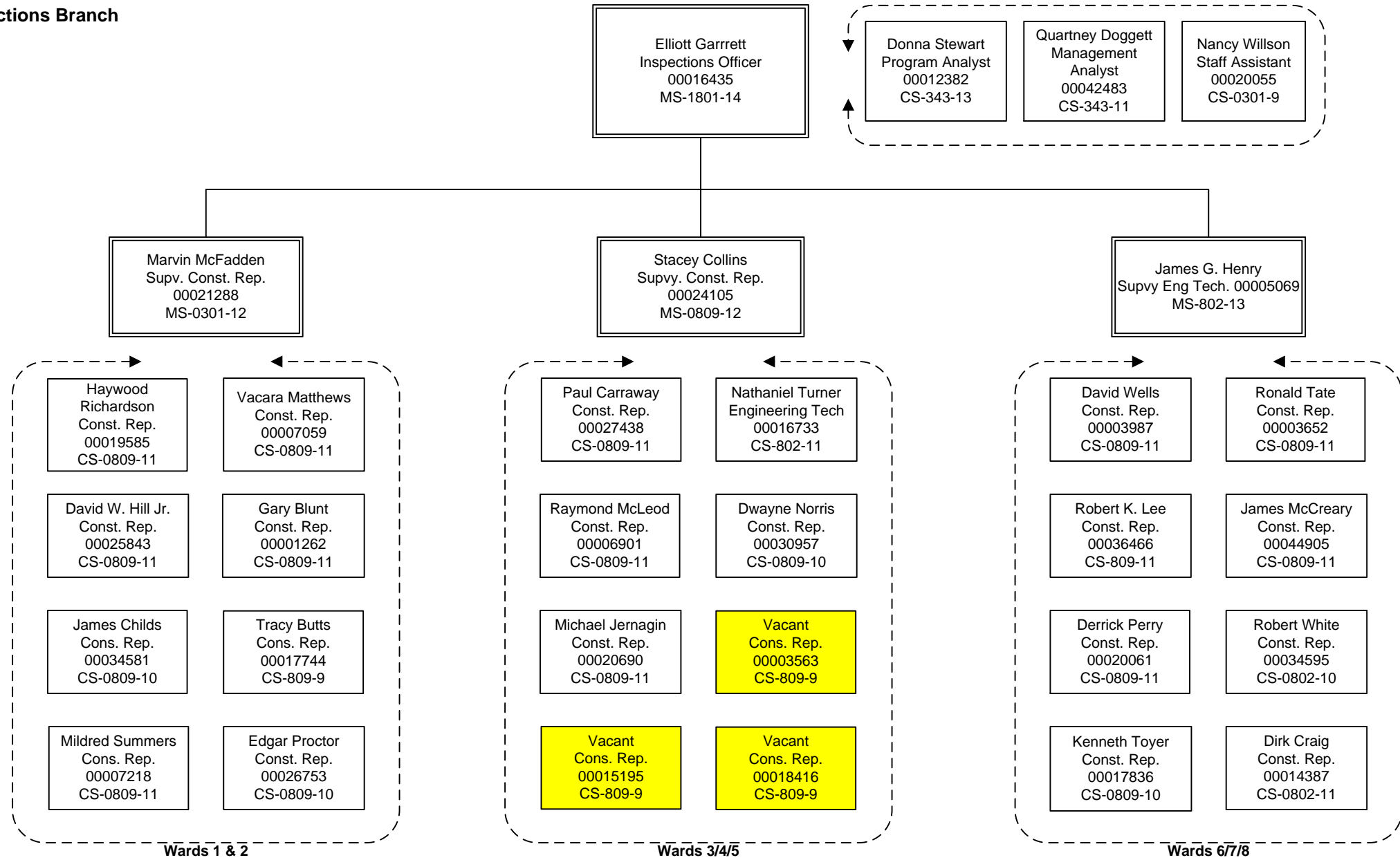

Approved by: Leif A. Dormsjo, Director

Signature: ----- Date: -----

District Department Of Transportation
Operations Administration
Office of the Chief Operations Officer
Public Space Regulation Division
Customer Service Team

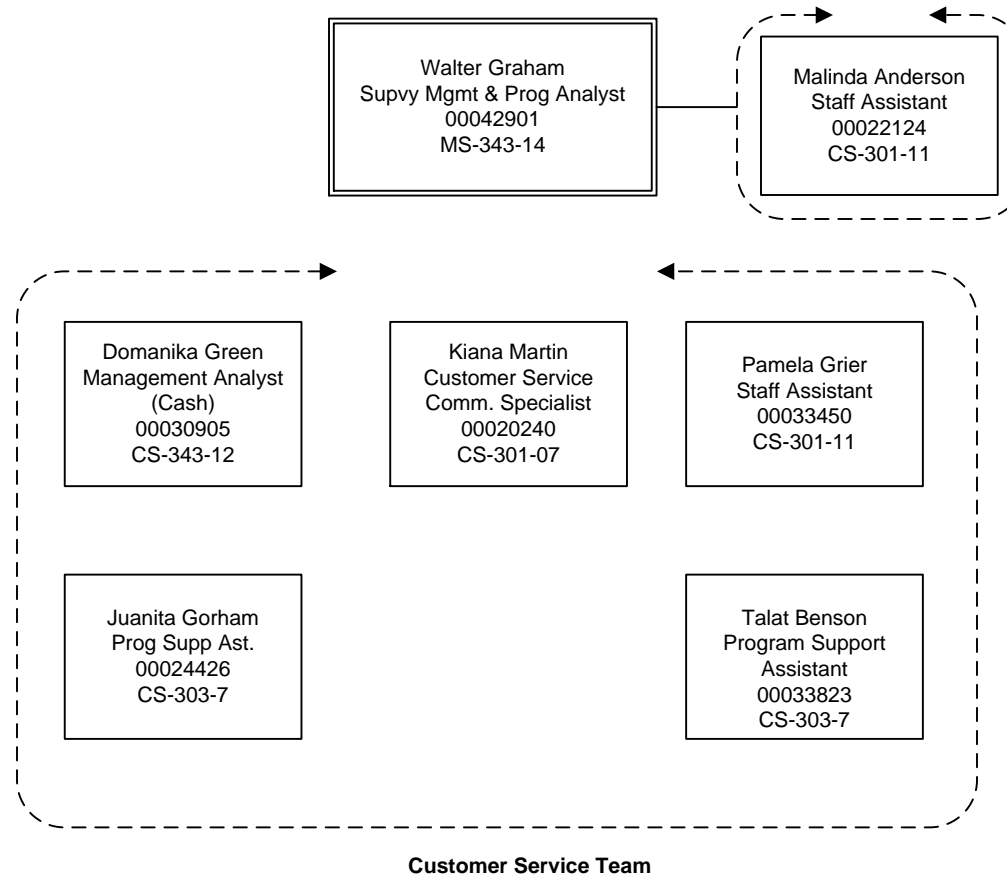

Approved by: Leif A. Dormsjo, Director

Signature: ----- Date: -----

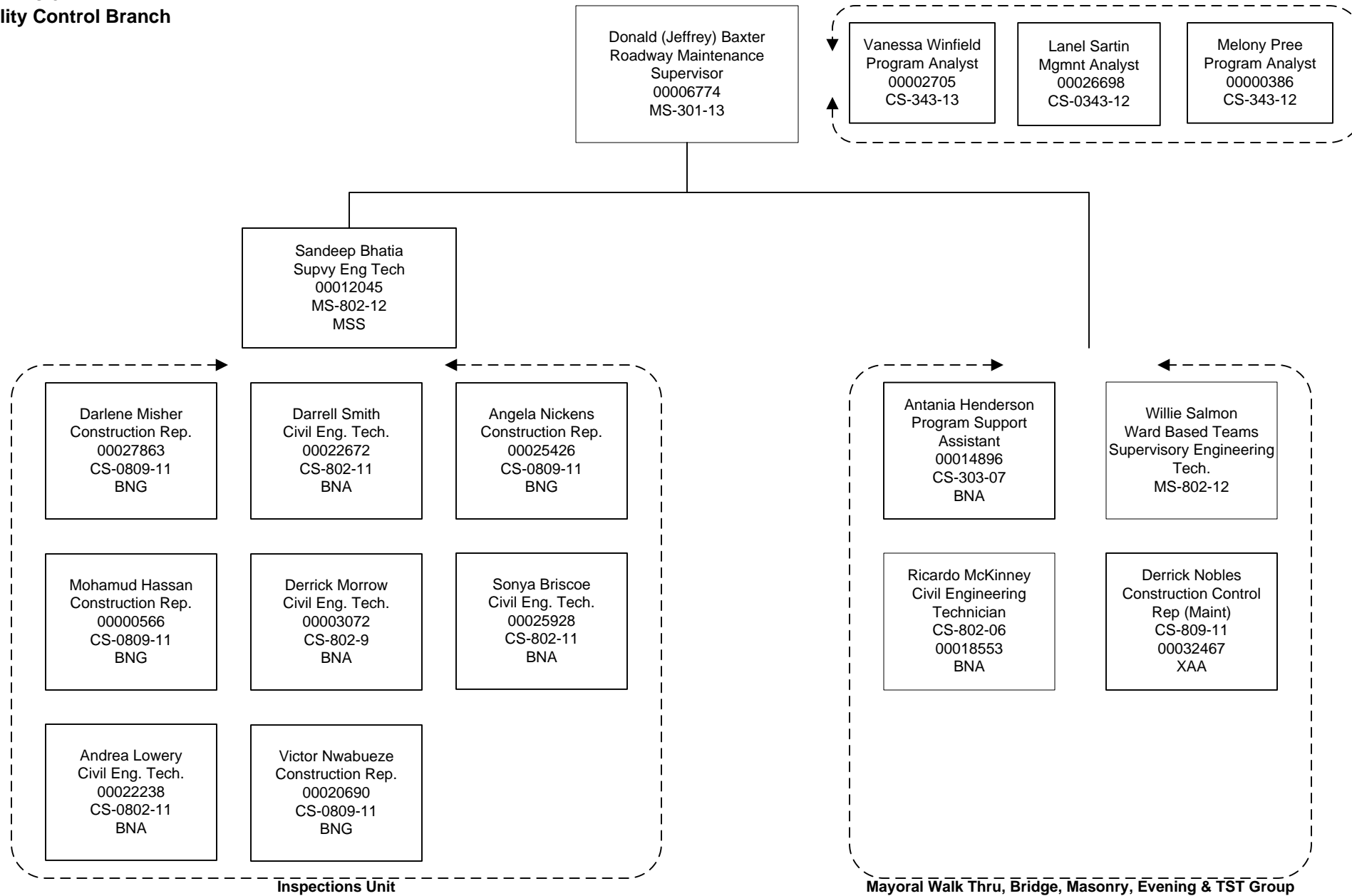

Approved by: Leif A. Dormsjo, Director

Signature: ----- Date: -----

District Department of Transportation
Operations Administration
Office of the Chief Operations Officer (COO)
Maintenance Division

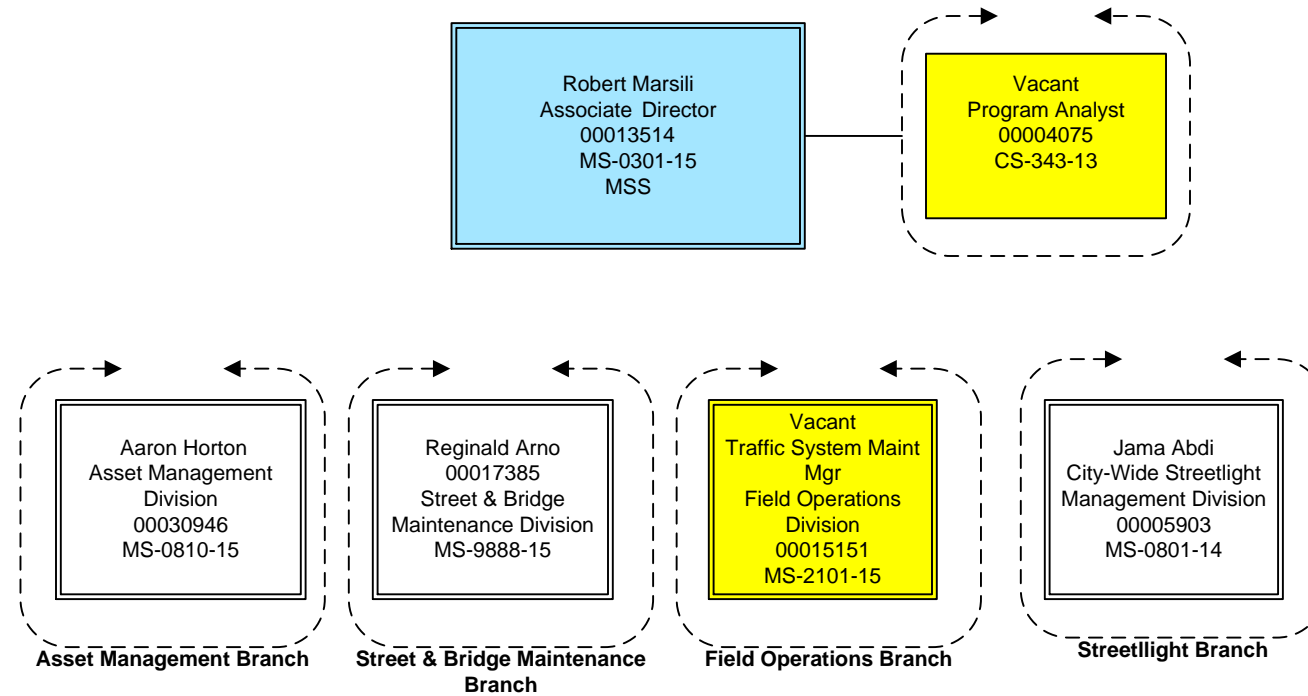

Approved by: Leif A. Dormsjo, Director

Signature: _____ Date: _____

District Department of Transportation
 Operations Administration
 Chief Operations Officer (COO)
 Maintenance Division
 Asset Management Branch

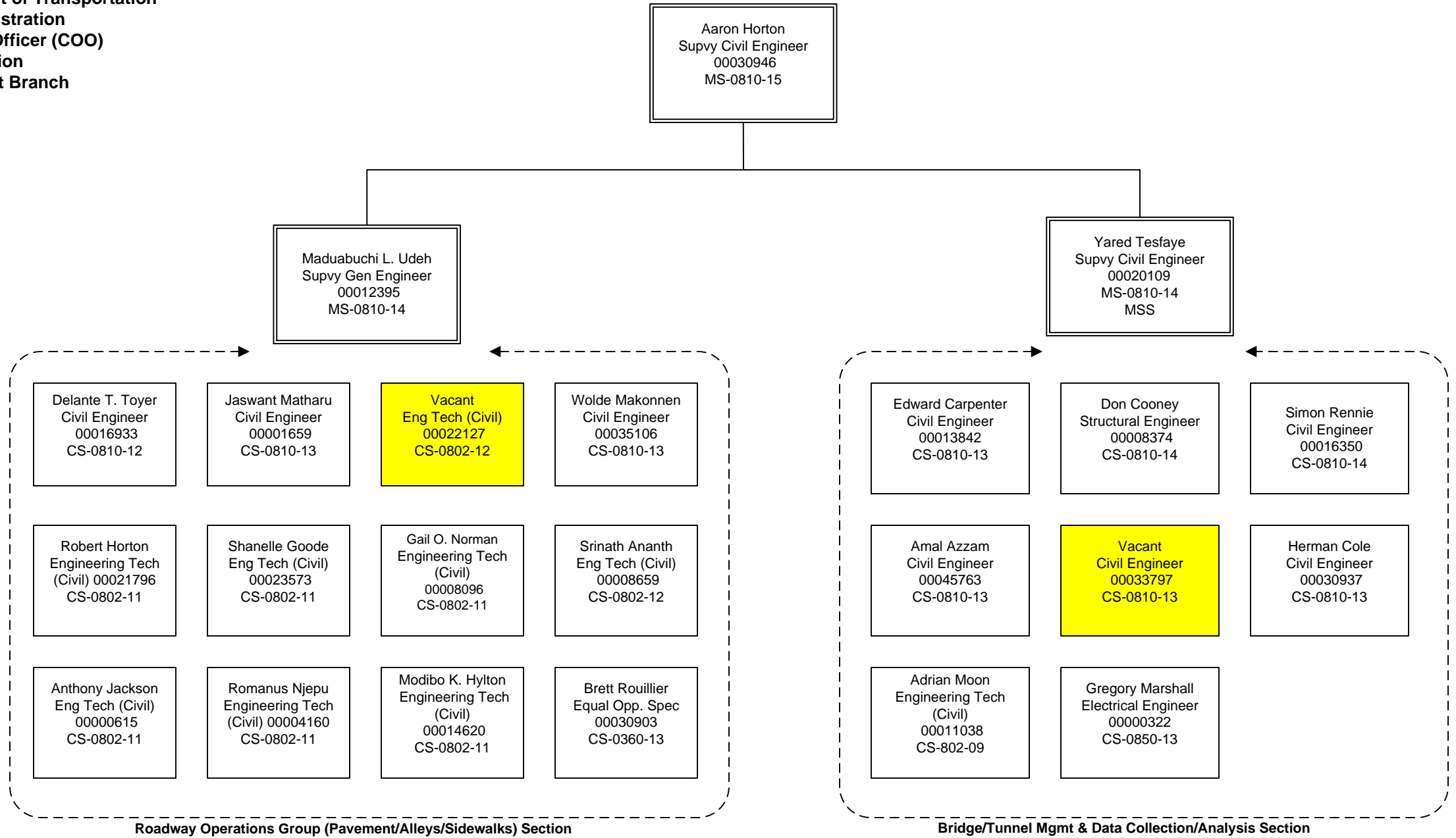

Approved by: Leif A. Dormsjo, Director

Signature: _____ Date: _____

District Department of Transportation
Operations Administration
Office of the Chief Operations Officer (COO)
Maintenance Division
Street and Bridge Maintenance Branch

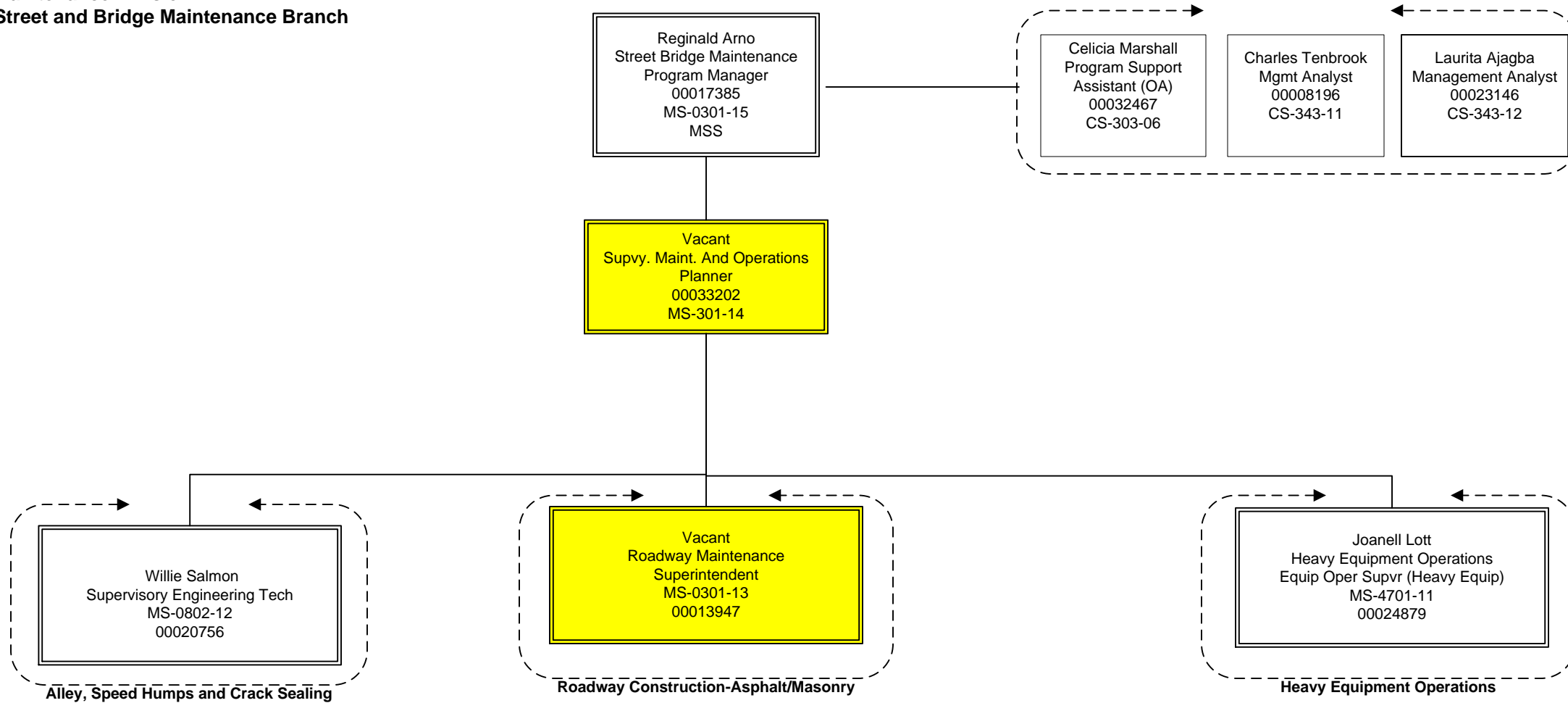

Approved by: Leif A. Dormsjo, Director

99 Active Employees
8 Vacancies

Signature: _____ Date: _____

District Department of Transportation
Operations Administration
Office of the Chief Operations Officer (COO)
Maintenance Division
Field Operations Branch

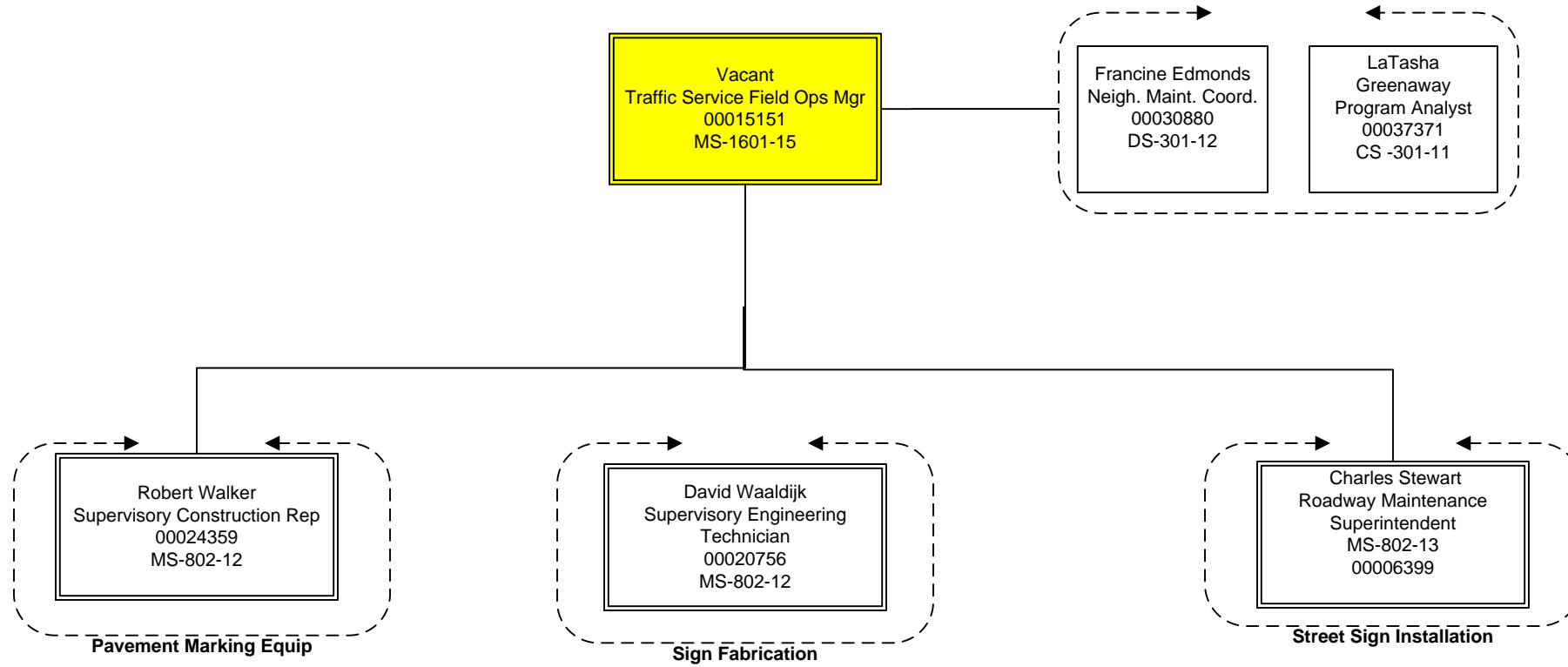

33 Employees FOD Unit

Approved by: Leif A. Dormsjo, Director

Signature: _____ Date: _____

District Department of Transportation
Office of the Operations Administration
Office of the Chief Operations Officer (COO)
Maintenance Division
Street Light Branch

Jama Abdi
Supervisory General
Engineer
00005903
MS-801-14

Fred Akinbolajo
Supervisory General
Engineer
00013347
MS -801-13

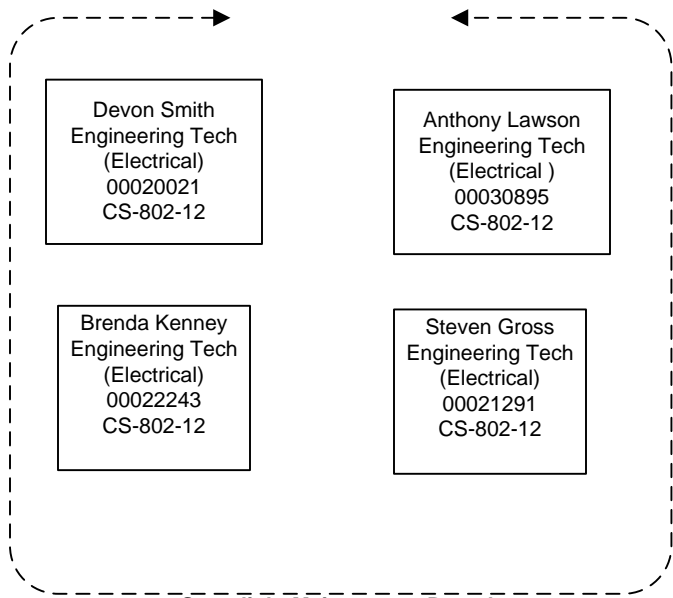

Streetlight Maintenance Branch

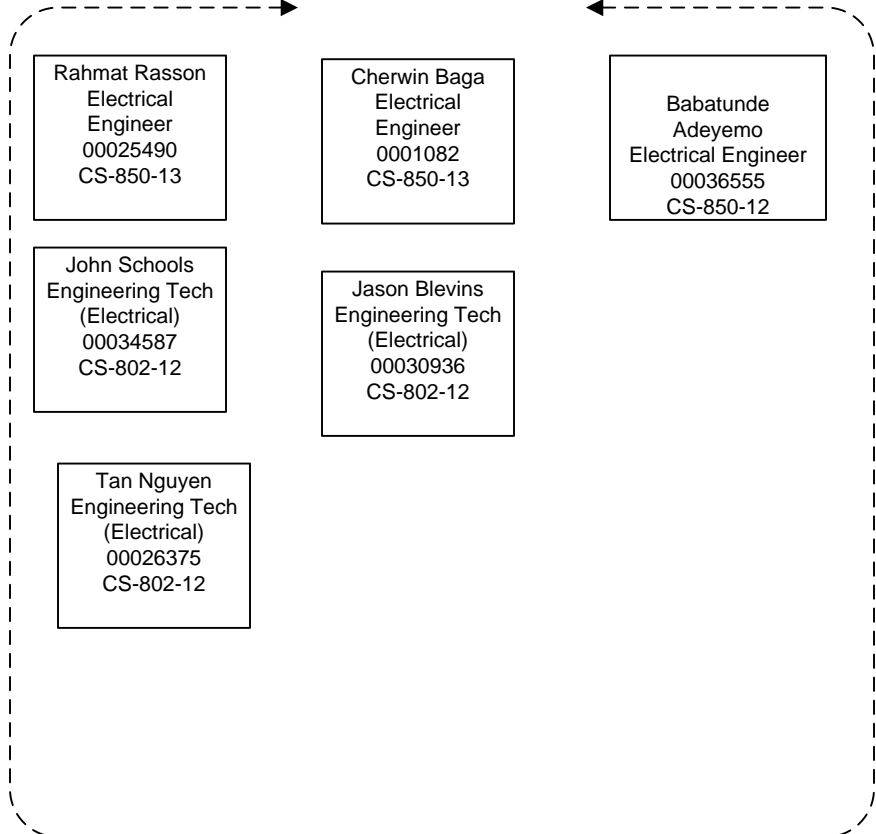

Streetlight Maintenance Branch

Approved by: Leif A. Dormsjo, Director

Signature: _____ Date: _____

District Department of Transportation
Operations Administration
Office of the Chief Operations Officer (COO)
Traffic Operations & Safety Division

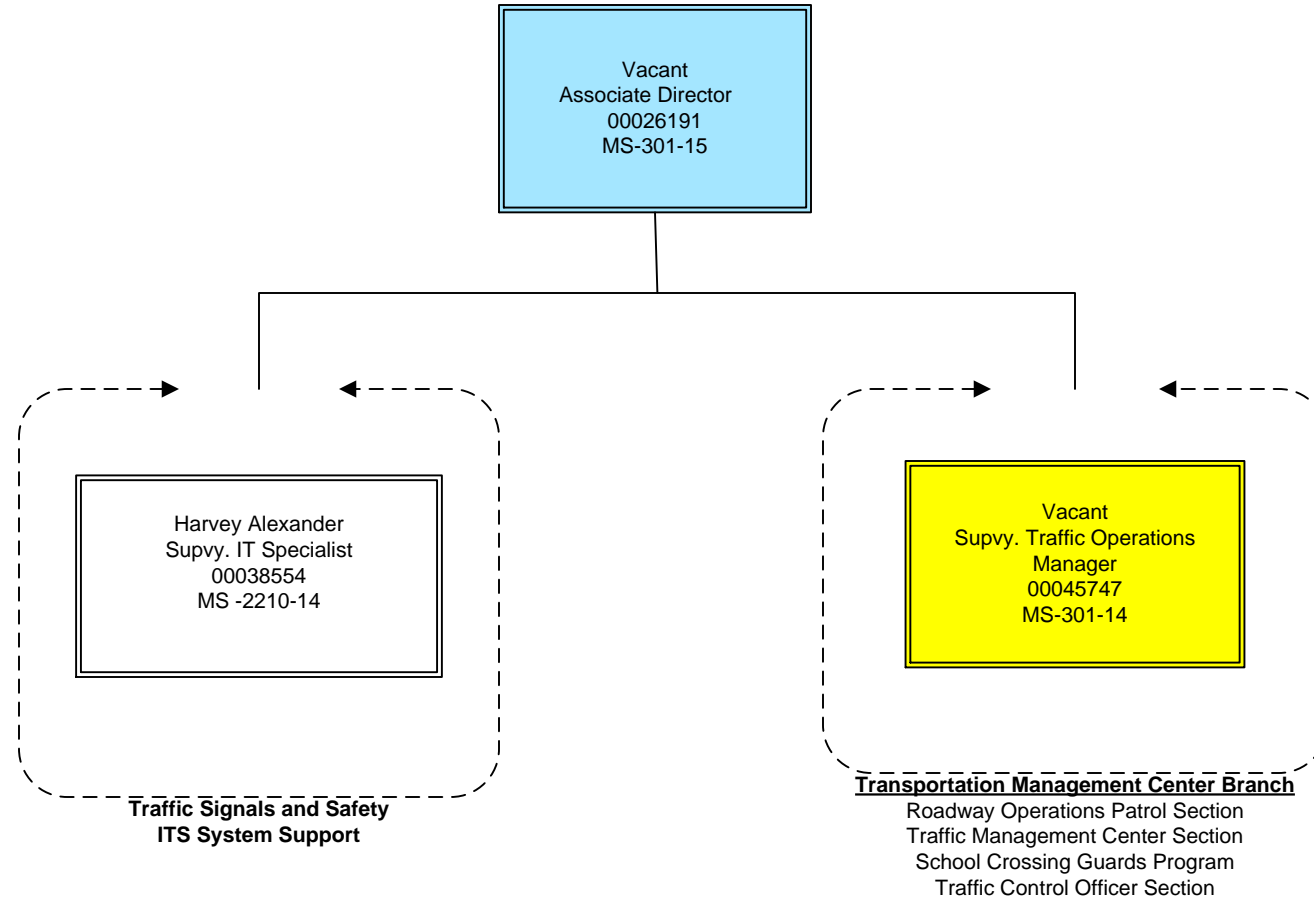

Approved by: Leif A. Dormsjo, Director

Signature: _____ Date: _____

**District Department of Transportation
Operations Administration
Office of the Chief Operations Officer (COO)
Traffic Operations & Safety Division
ITS System Support and Traffic Signals**

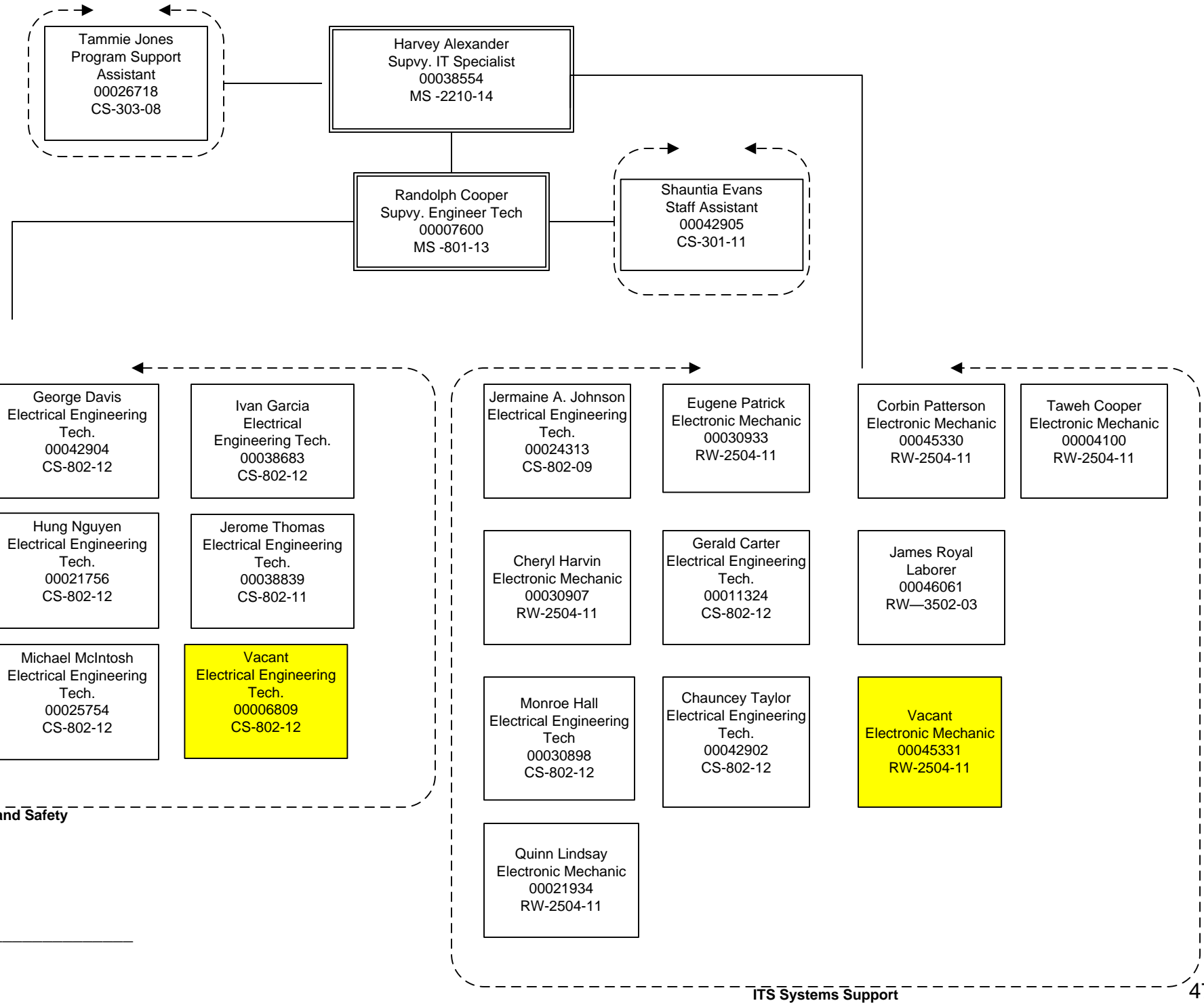

Approved by: Leif A. Dormsjo, Director

Signature: _____ Date: _____

District Department of Transportation
Operations Administration
Office of the Chief Operations Officer (COO)
Traffic Operations & Safety Division
Traffic Operations Branch

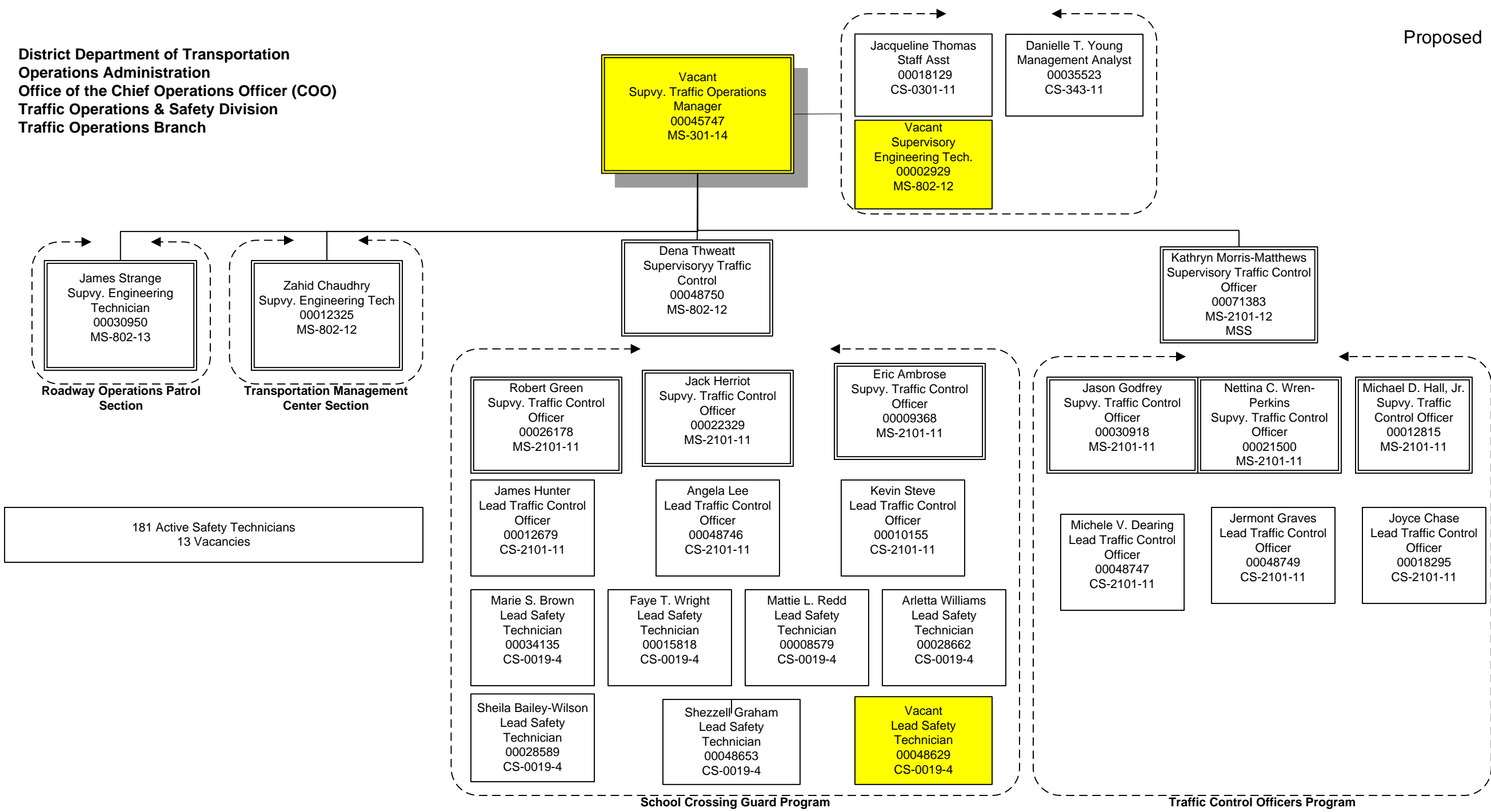

Approved by: Leif A. Dormsjo, Director

Signature: _____ Date: _____

District Department of Transportation
Operations Administration
Office of the Chief Operations Officer (COO)
Traffic Operations & Safety Division
Roadway Operations Patrol

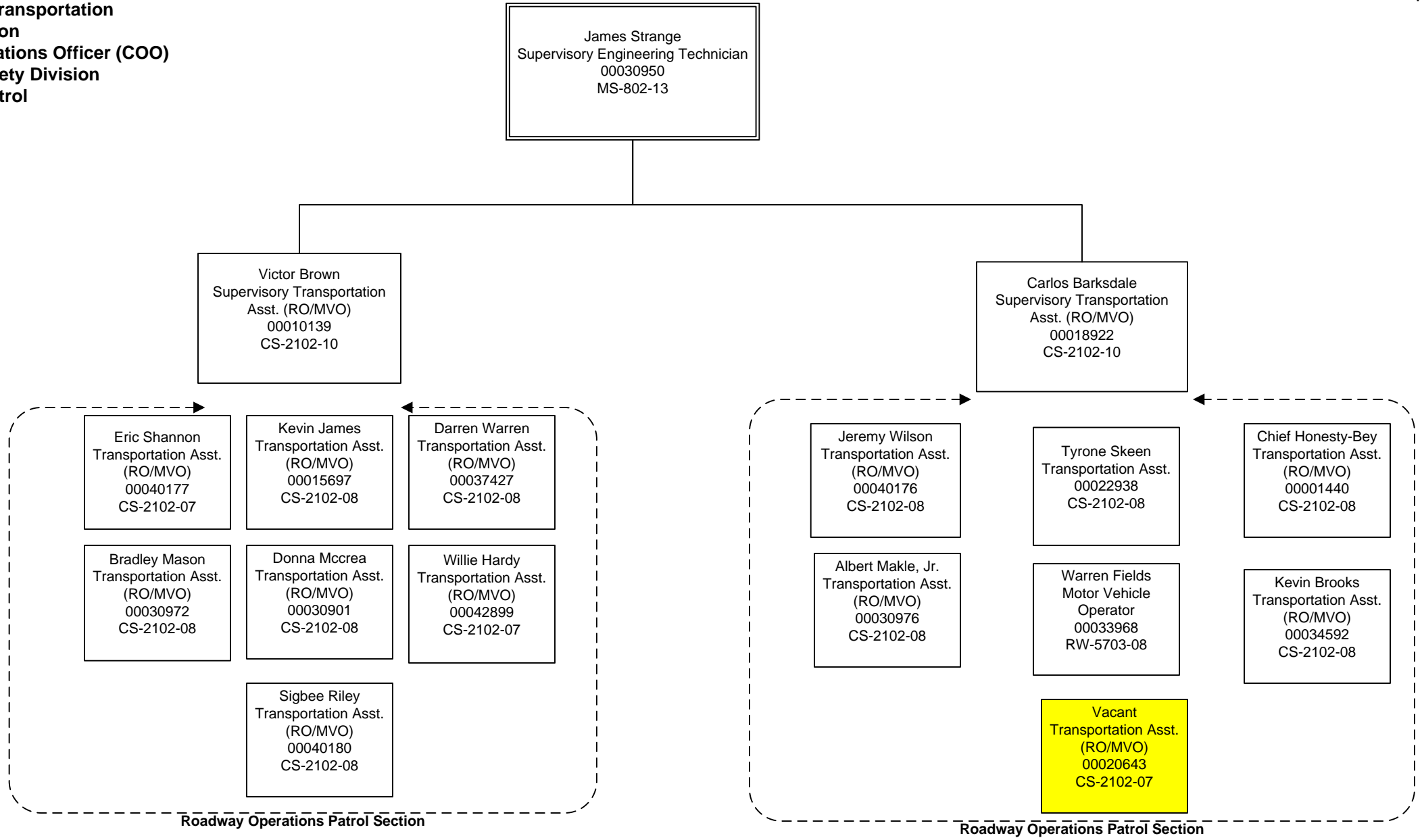

Approved by: Leif A. Dormsjo, Director

Signature: _____ Date: _____

District Department of Transportation
Operations Administration
Office of the Chief Operations Officer (COO)
Traffic Operations & Safety Division
Transportation Management Center

Zahid Chaudhry
Supvy. Engineering Tech
00012325
MS-802-12

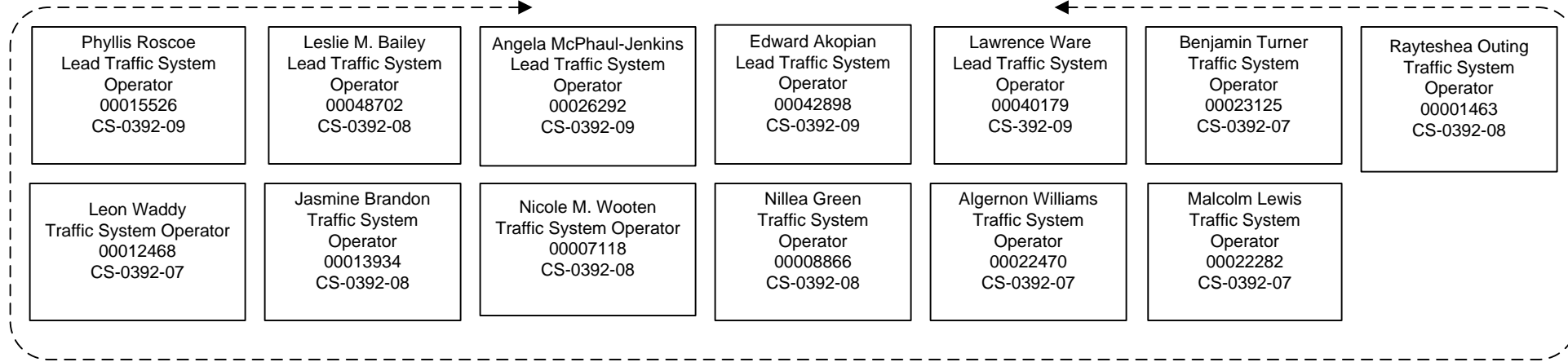

Transportation Management Center Branch
MLK BLDG

Approved by: Leif A. Dormsjo, Director

Signature: _____ Date: _____

School Crossing Guards Program

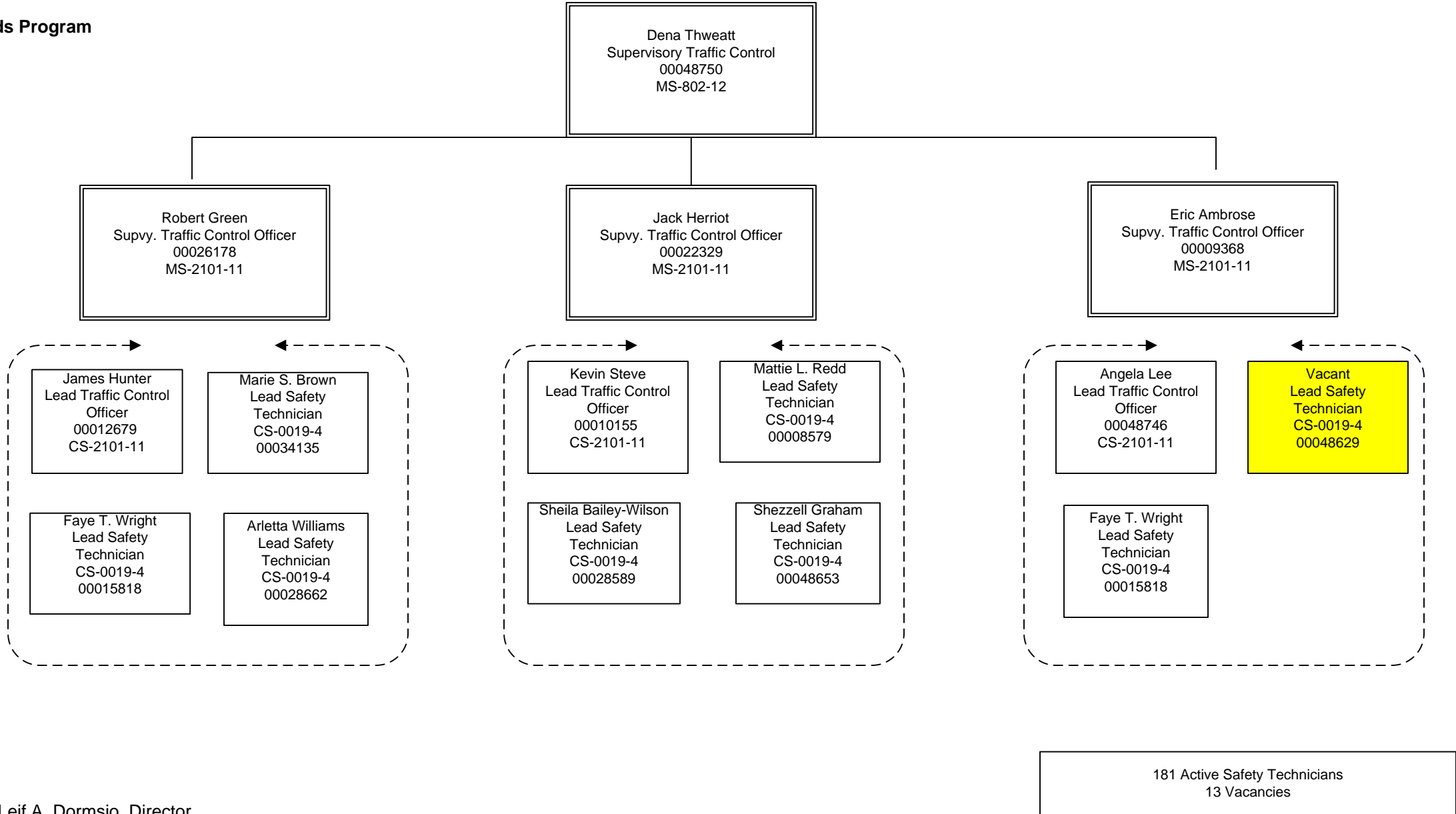

Approved by: Leif A. Dormsjo, Director

Signature: _____ Date: _____

District Department of Transportation
Operations Administration
Office of the Chief Operations Officer (COO)
Transportation Operations Division
Traffic Control Officer Program

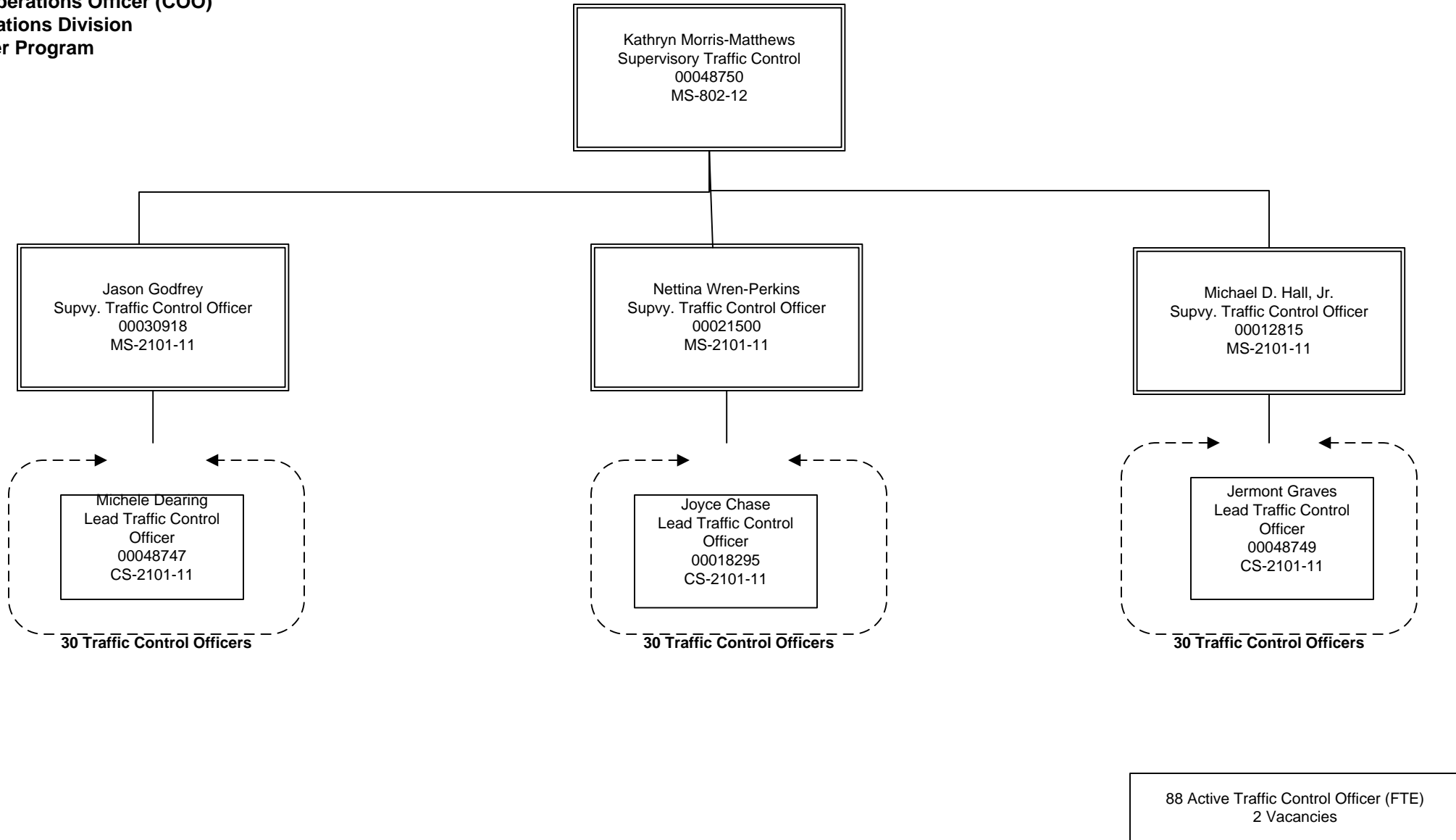

Approved by: Leif A. Dormsjo, Director

Signature: _____ Date: _____

**District Department of Transportation
Office of the Director
Office of the Chief Administrative Officer**

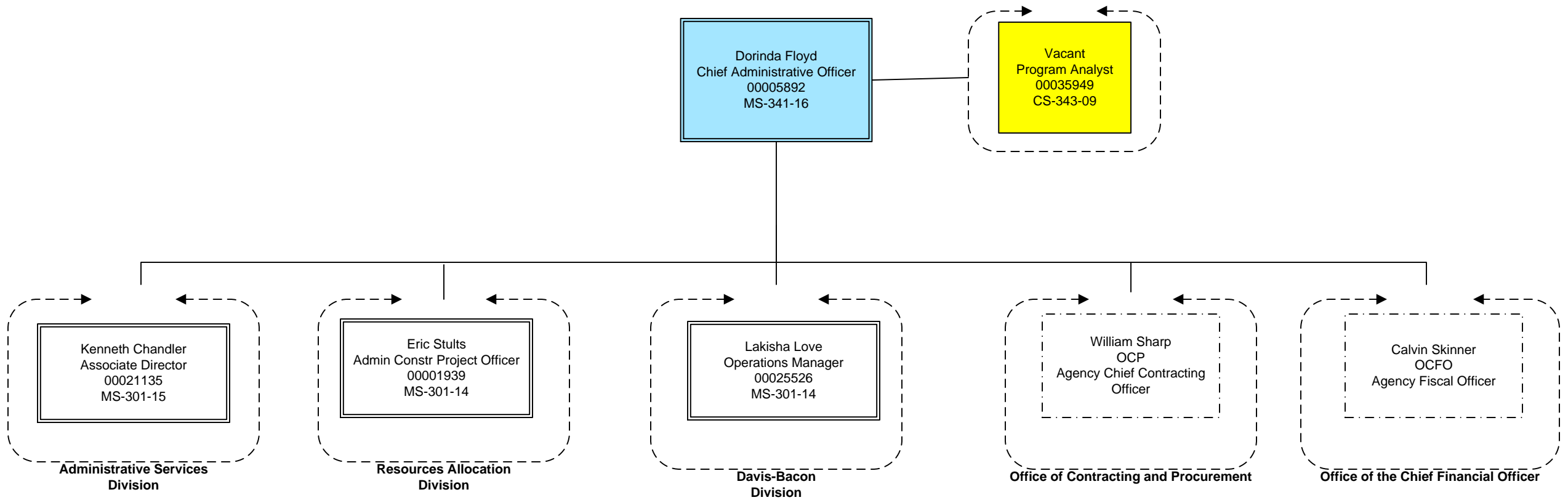

Approved by: Leif A. Dormsjo, Director

Signature: _____ Date: _____

**District Department of Transportation
Office of the Director
Office of the Chief Administrative Officer
Administrative Services Division**

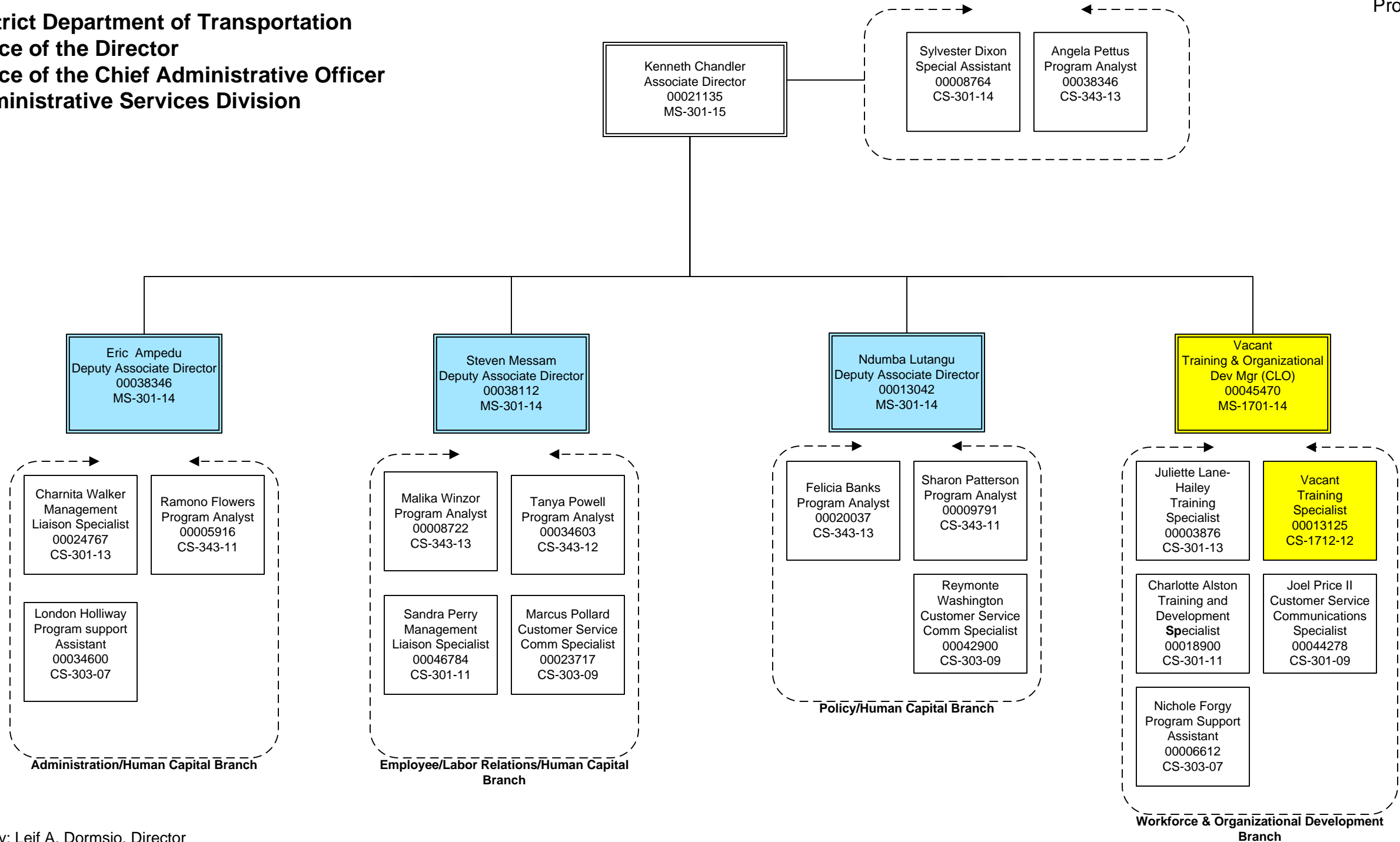

Approved by: Leif A. Dormsjo, Director

Signature: _____ Date: _____

**District Department of Transportation
Office of the Director
Office of the Chief Administrative Officer
Resource Allocation Division**

Eric Stults
Admin Constr Project Officer
00001939
MS-301-14

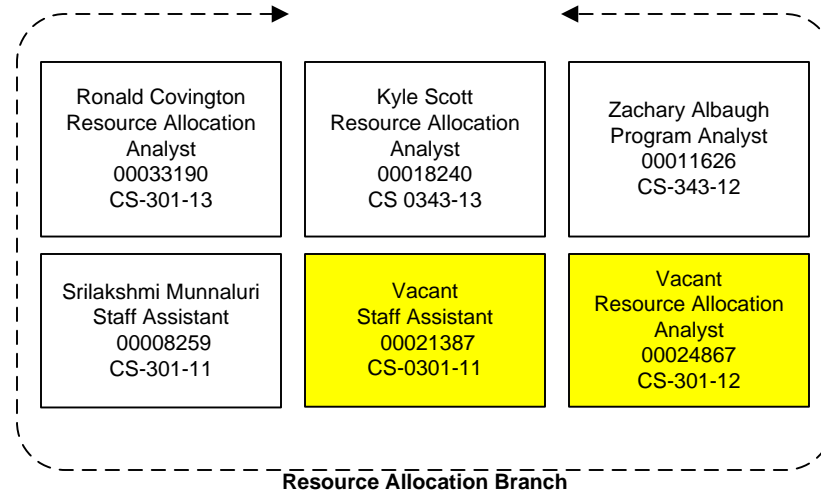

Approved by: Leif A. Dormsjo, Director

Signature: _____ Date: _____

**District Department of Transportation
Office of the Director
Office of the Chief Administrative Officer
Davis Bacon Division**

Proposed

Lakisha Love
Operations Manager
00025526
MS-301-14

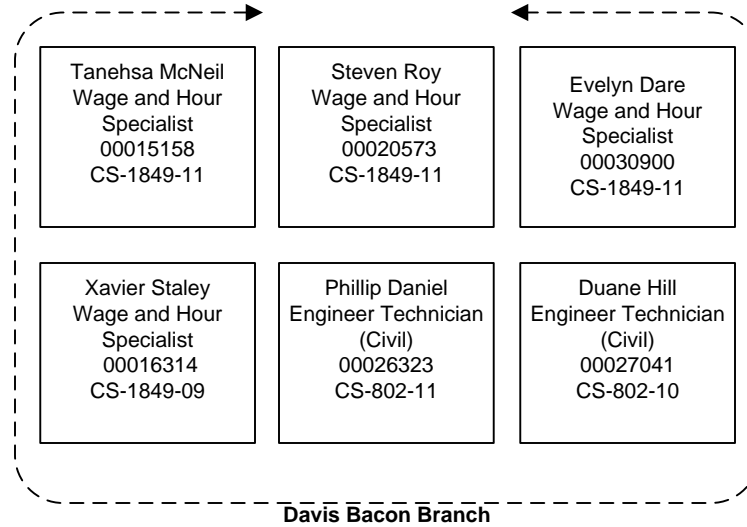

Approved by: Leif A. Dormsjo, Director

Signature: _____ Date: _____

**District Department of Transportation
Office of the Director
Office of the Chief Performance Officer**

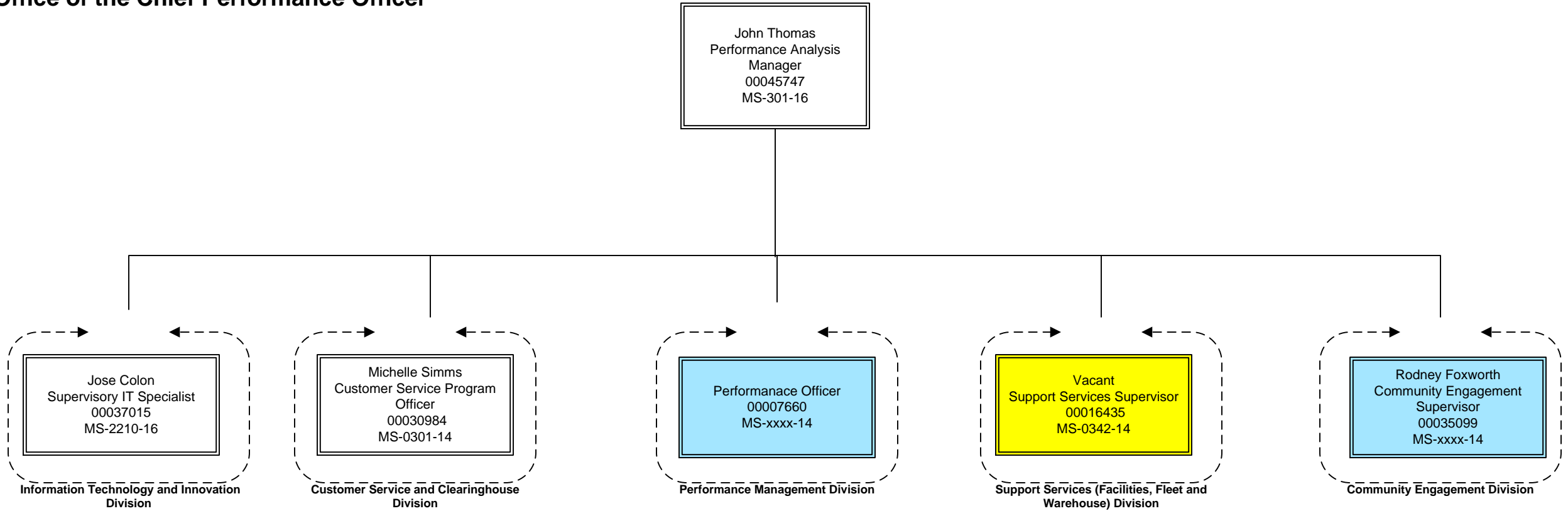

Approved by: Leif A. Dormsjo, Director

Signature: _____ Date: _____

**District Department of Transportation
Performance Administration
Office of the Chief Performance Officer
Information Technology Division**

Proposed

Jose Colon
Supervisory IT Specialist
00037015
MS-2210-16

Greer Hill
Program Analyst
00004580
CS-343-13

George Lejano
Writer-Editor
(Webmaster)
00027692
CS-1082-13

Amanda Ware
Customer Serv Prog
Specialist
00021886
CS-301-13

Cheryl Ball
Transportation
Specialist
00016562
CS-2201-12

Chris Quay
Technical Writer
00001862
CS-1082-12

Project Management Operations

James Graham
Supervisory IT Specialist
(GIS)
00030930
MS-301-15

Baba Bamisaiye
Supvy IT Specialist (Cust
Support)
00035577
MS-2210-15

Leela Shivadhanam
IT Specialist
00002859
CS-2210-14

Ramakrishna
Nimmagadda
IT Specialist
00037014
CS-2210-14

Christopher Faust
IT Specialist
00030944
CS-2210-14

Jon Jones
GIS Developer
00044781
CS-301-14

Faisal Khan
IT Specialist
00020824
CS-2210-14

Washington Karvee
IT Specialist
0008237
CS-2210-12

Applications & Development Support Branch

Isdore Anyanwu
IT Specialist (Program
Manager)
00035020
CS-2210-14

Khalif Hired
Information Technical
Specialist
00007443
CS 2210-14

Elizabeth Lamont
IT Specialist
00023624
CS-2210-11

Marlene Johnson
Telecom Specialist
00030948
CS-301-12

Rasheed Ali
IT Specialist (Network
Services)
00014318
CS-2210-11

Mohamed Said
Computer Engineer
00008690
CS-0854-12

Jonathan Wilson
IT Specialist
00030982
CS-2210-11

Rumon Toatley
Program Support Asst
00046072
CS-301-09

Infrastructure & Customer Support Branch

Approved by: Leif A. Dormsjo, Director

Signature: _____ Date: _____

**District Department of Transportation
 Performance Administration
 Office of the Chief Performance Officer
 Customer Service Clearinghouse Division**

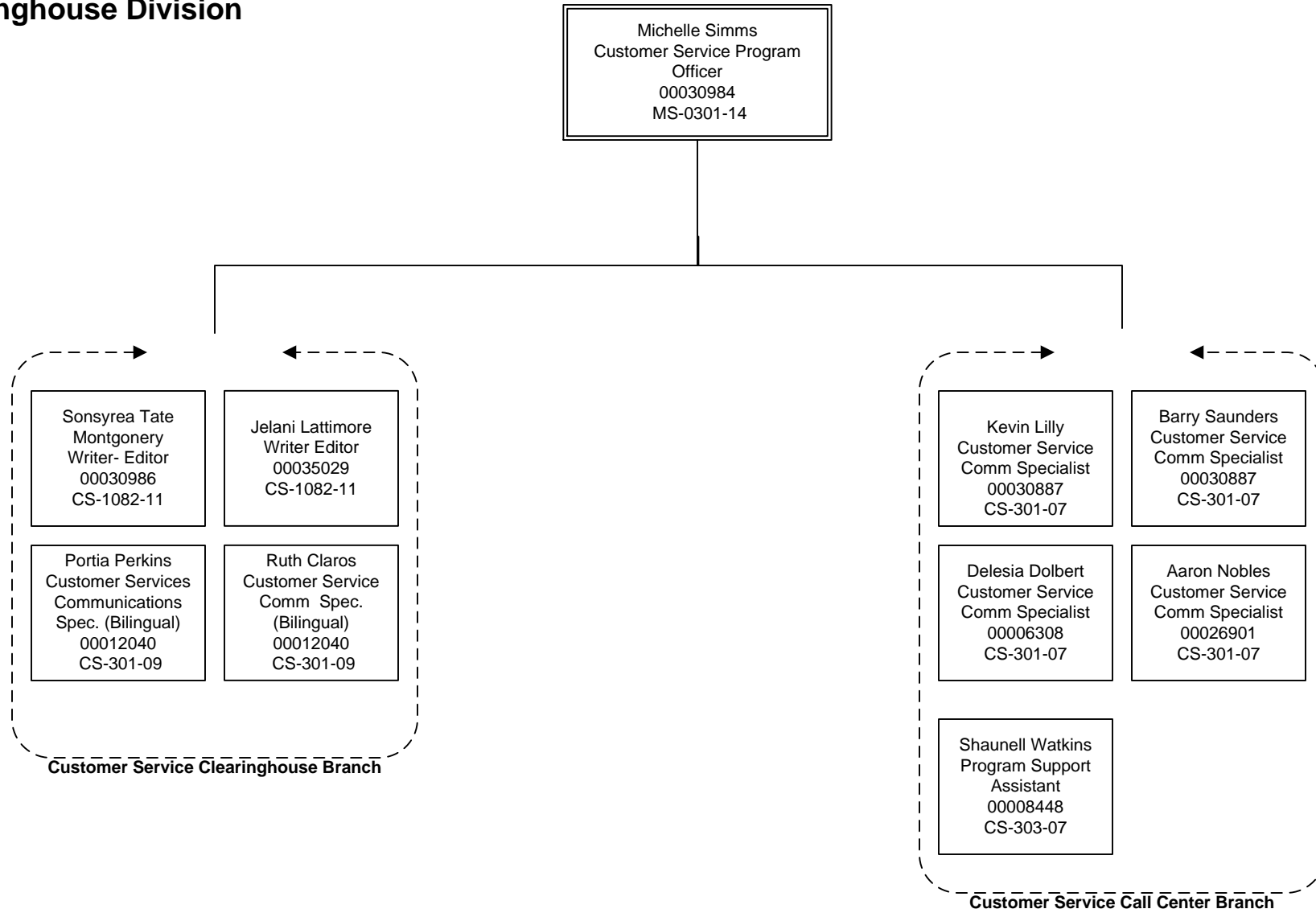

Approved by: Leif A. Dormsjo, Director

Signature: _____ Date: _____

District Department of Transportation
Performance Administration
Office of the Chief Performance Officer
Performance Management Division

Proposed

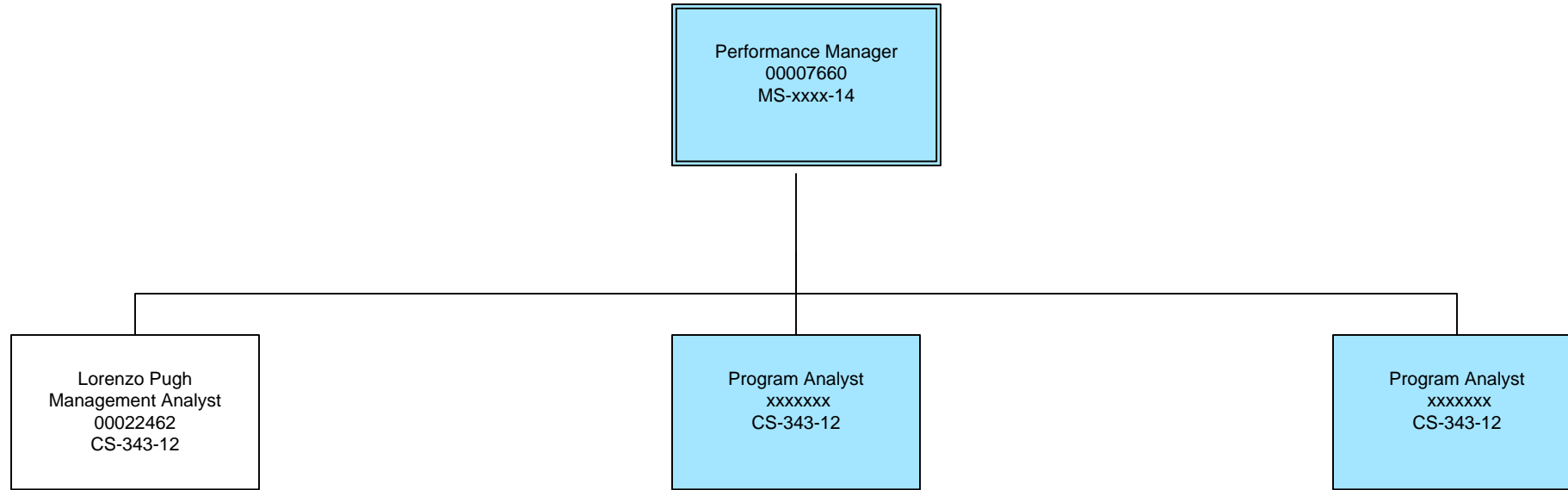

**District Department of Transportation
Performance Administration
Office of the Chief Performance Officer
Support Services Division**

Proposed

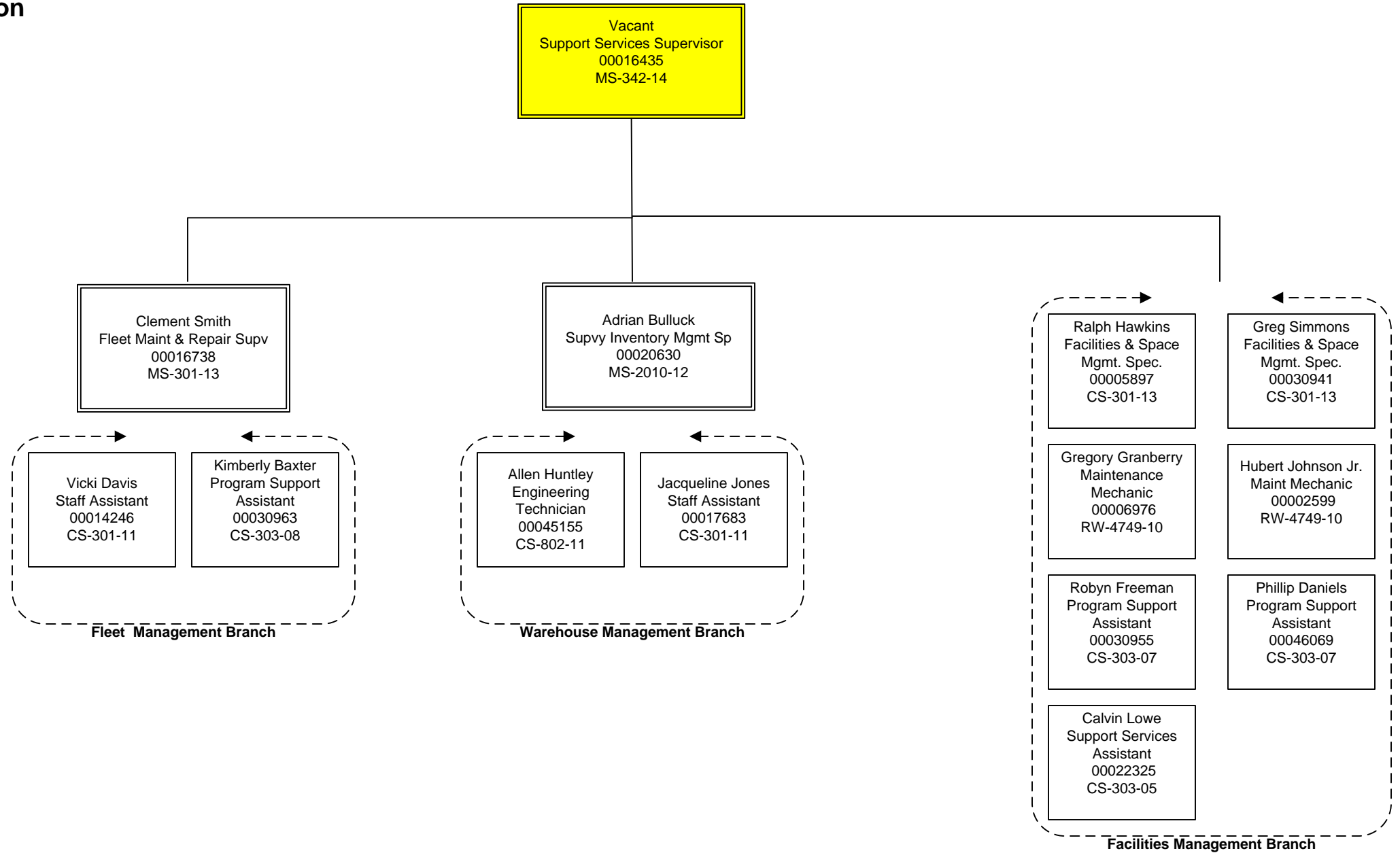

Approved by: Leif A. Dormsjo, Director

Signature: _____ Date: _____

**District Department of Transportation
Performance Administration
Office of the Chief Performance Officer
Community Engagement Division**

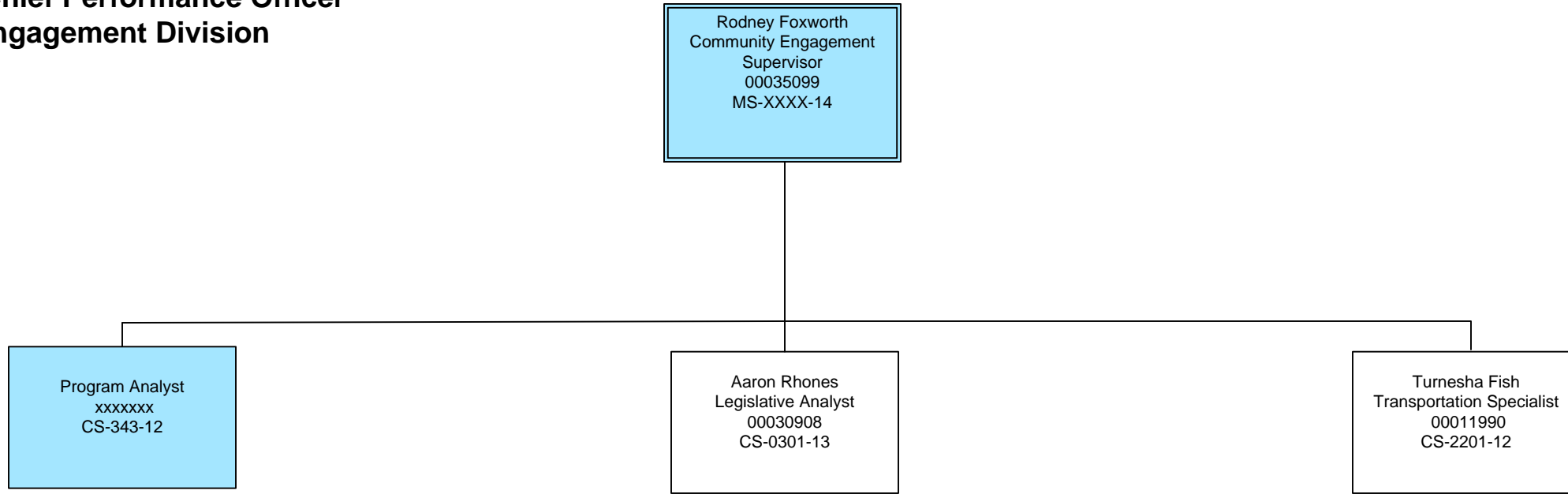

Approved by: Leif A. Dormsjo, Director

Signature: _____ Date: _____

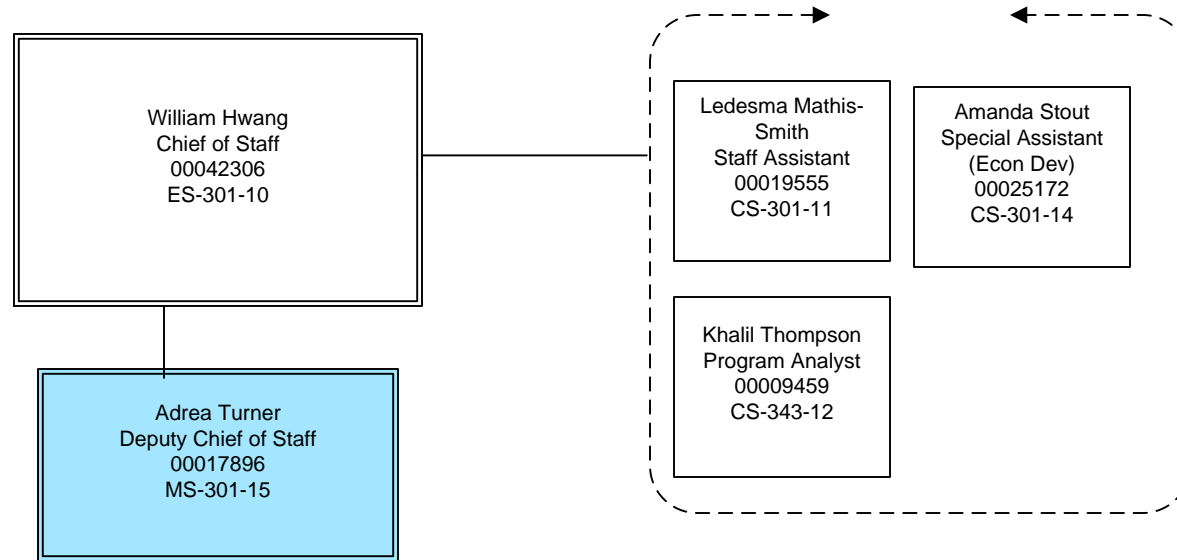

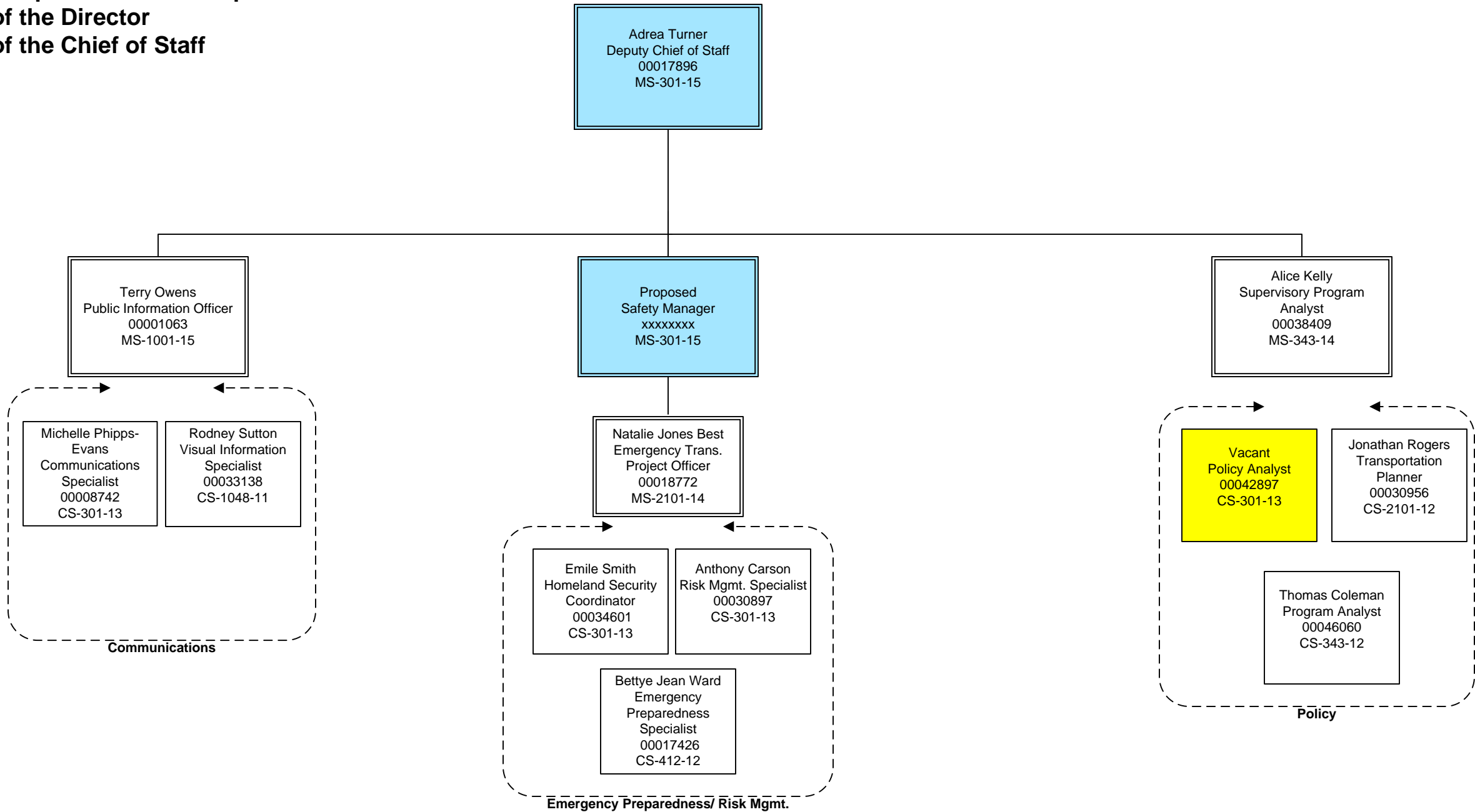

Approved by: Leif A. Dormsjo, Director
Signature: _____ Date: _____

Department ID	Department Name	Job Title	Employee Name	Hire Date	Vacant / Filled Status	Grade	Step	Salary	Series	F/P Time	Reg/Term/Temp	
AA10000000	Office of the Director	Executive Office of the Mayor	Outreach & Service Specialist	Benab,Yasmin	3/2/2015	F	5	0	72534.66	0301	F	Reg
AA18000000	Office of Federal and Regional	STAFF ASSISTANT	Lancaster,Patrice D	2/23/2015	F	9	7	54595	0301	F	Term	
AA19000000	Office of Community Affairs	Outreach & Service Specialist	Felder,Wendell E	2/23/2015	F	5	0	72534.66	0301	F	Reg	
AA19000000	Office of Community Affairs	Outreach & Service Specialist	Rojo,Luis G	2/18/2015	F	5	0	72534.66	0301	F	Reg	
AH10000000	Mayor's Office of Legal Counsel	Associate Director			V	7	0	98482	0301	F	Reg	
AH10000000	Mayor's Office of Legal Counsel	Special Assistant			V	5	0	70344	0301	F	Reg	
KA10000000	OFFICE OF DIRECTOR	Chief Administrative Officer	Floyd,Dorinda	6/29/2015	F	16	0	140945.2	0341	F	Reg	
KA10000000	OFFICE OF DIRECTOR	Chief of Staff	Hwang,William B	1/26/2015	F	10	0	135960	0301	F	Reg	
KA10000000	OFFICE OF DIRECTOR	Deputy Chief of Staff	Turner,Adrea	4/20/2015	F	15	0	107399.1	0301	F	Reg	
KA10000000	OFFICE OF DIRECTOR	Deputy Dir Neighborhood Engage	Foxworth,Rodney	10/13/2015	F	7	0	105000	0301	F	Reg	
KA10000000	OFFICE OF DIRECTOR	Deputy Director	Gillis,Greer J	2/18/2015	F	10	0	159650	0601	F	Reg	
KA10000000	OFFICE OF DIRECTOR	Director, Dist Dept of Transp.	Dormsjo,Leif Anders	1/2/2015	F	E5	0	172010	0301	F	Reg	
KA10000000	OFFICE OF DIRECTOR	Executive Assistant	Barnes,Regina	6/8/2015	F	12	1	68294	0301	F	Reg	
KA10000000	OFFICE OF DIRECTOR	Legislative Analyst	Rhones,Aaron R	6/9/2008	F	13	9	98863	0301	F	Reg	
KA10000000	OFFICE OF DIRECTOR	Management Analyst	Muldrow,Kim L	10/12/2010	F	12	2	70414	0343	F	Reg	
KA10000000	OFFICE OF DIRECTOR	Performance Analysis Manager	Thomas,John P	5/12/2003	F	16	0	151607	0301	F	Reg	
KA10000000	OFFICE OF DIRECTOR	Special Assistant	Conley,Yvette E.	7/29/2013	F	14	10	119811	0301	F	Reg	
KA10000000	OFFICE OF DIRECTOR	Special Assistant	Stout,Amanda	9/8/2015	F	14	2	95979	0301	F	Reg	
KA10000000	OFFICE OF DIRECTOR	STAFF ASSISTANT	Smith-Mathis,Ledesma	10/30/2006	F	11	3	58743	0301	F	Reg	
KA11000000	Resource Management	ADMIN CONSTR PROJECT OFFICER	Stults,Eric W	3/28/2015	F	14	0	126119.3	0301	F	Reg	
KA11000000	Resource Management	Engineering Tech. (Civil)	Daniel,Phillip S	9/8/1992	F	11	7	71212	0802	F	Reg	
KA11000000	Resource Management	Engineering Tech. (Civil)	Hill,Duane A	4/24/2000	F	10	5	61331	0802	F	Reg	
KA11000000	Resource Management	OPERATIONS MGR	Love,Lakisha	1/18/2000	F	14	0	112129.7	0301	F	Reg	
KA11000000	Resource Management	Program Analyst	Albaugh,Zachary M	7/12/2004	F	12	6	78894	0343	F	Reg	
KA11000000	Resource Management	Program Analyst			V	9	1	45811	0343	F	Reg	
KA11000000	Resource Management	Resource Allocation Analyst	Scott,Kyle J	4/23/2012	F	13	2	81209	0301	F	Reg	
KA11000000	Resource Management	Resource Allocation Analyst	Covington,Ronald	4/13/2009	F	13	10	101385	0301	F	Reg	
KA11000000	Resource Management	STAFF ASSISTANT	Munnaluri,Srilakshmi	8/25/2003	F	11	5	67374	0301	F	Reg	
KA11000000	Resource Management	STAFF ASSISTANT			V	11	1	55195	0301	F	Reg	
KA11000000	Resource Management	Wage and Hour Specialist	Staley,Xavier	6/30/2014	F	9	5	51667	1849	F	Term	
KA11000000	Resource Management	Wage and Hour Specialist	Roy,Steven	6/30/2014	F	11	2	56969	1849	F	Term	
KA11000000	Resource Management	Wage and Hour Specialist	Dare,Evelyn	6/30/2014	F	11	2	56969	1849	F	Term	
KA11000000	Resource Management	Wage and Hour Specialist	McNeil,Taneshia R	2/19/2008	F	11	5	62291	1849	F	Term	
KA11100000	Office of the Director Support	Program Analyst	Banks,Felicia L	7/7/2008	F	13	3	83731	0343	F	Reg	
KA11100000	Office of the Director Support	Program Analyst	Coleman,Thomas	12/15/2014	F	12	5	76774	0343	F	Reg	
KA11200000	Office of Emergency Preparedne	EMERGENCY PREPARE SPEC	Ward,Bettye Jean	12/27/2004	F	12	6	78894	0301	F	Reg	
KA11200000	Office of Emergency Preparedne	Emergency Transportation Proje	Jones,Natalie E	6/7/1999	F	14	0	116501.1	2101	F	Reg	
KA11200000	Office of Emergency Preparedne	Risk Management Specialist	Carson,Anthony	7/19/2004	F	13	7	93819	0301	F	Reg	
KA11300000	Communications	Communications Specialist	Phipps Evans,Michelle B	6/19/2013	F	13	2	81209	0301	F	Reg	
KA11300000	Communications	Public Information Officer	Owens,Terry	9/8/2015	F	15	0	140032.6	1001	F	Reg	
KA11300000	Communications	Visual Information Specialist	Sutton,Rodney	9/8/2014	F	11	4	60517	1084	F	Reg	
KA11500000	Administrative Services Branch	Assoc. Dir., Admin. Services	Chandler,Kenneth	3/24/2014	F	15	0	143221.5	0301	F	Reg	
KA11500000	Administrative Services Branch	CUSTOMER SERVICE COMM SPEC	Washington,Reymonte T	9/2/2008	F	9	4	50203	0301	F	Reg	
KA11500000	Administrative Services Branch	Operations Manager	Ampedu,Eric Osei	1/22/2006	F	14	0	96755.14	0301	F	Reg	
KA11500000	Administrative Services Branch	OPERATIONS MGR	LUTANGU,NDUMBA	1/23/2006	F	14	0	96755.51	0301	F	Reg	
KA11500000	Administrative Services Branch	PROGRAM ANALYST	Flowers,Ramono E	5/7/2012	F	11	2	56969	0343	F	Reg	
KA11500000	Administrative Services Branch	Program Support Assistant (OA)	Piper,Nicole	6/2/2014	F	7	2	39244	0303	F	Term	
KA11500000	Administrative Services Branch	Program Support Assistant (OA)	Hollway,London	12/31/2012	F	7	3	40561	0303	F	Reg	
KA11500000	Administrative Services Branch	Program Support Assistant (OA)	Zeroual,Fatima	10/28/2013	F	7	2	39244	0303	F	Term	
KA11500000	Administrative Services Branch	Special Assistant	Dixon,Sylvester J	6/6/1989	F	14	5	104916	0301	F	Reg	
KA11510000	Customer Service Clearinghouse	Customer Services Program Spec	Ware,Amanda H	11/13/2006	F	13	6	91297	0301	F	Reg	
KA11510000	Customer Service Clearinghouse	Customer Svs Comm Spec (Billn)	Clarus,Ruth L	5/8/2000	F	9	7	54595	0301	F	Reg	
KA11510000	Customer Service Clearinghouse	Customer Svs Communications Sp	Dolberry,Delesia	9/9/2013	F	7	7	45829	0301	F	Term	
KA11510000	Customer Service Clearinghouse	Customer Svs Communications Sp	Perkins,Portia C	8/27/2012	F	7	5	43195	0301	F	Reg	
KA11510000	Customer Service Clearinghouse	Customer Svs Program Officer	Simms,Michelle Mccoy	4/9/2012	F	14	0	96755.51	0301	F	Reg	
KA11510000	Customer Service Clearinghouse	Program Support Asst (OA)	Watkins,Shaunell	7/29/2013	F	7	3	40561	0303	F	Reg	
KA11510000	Customer Service Clearinghouse	Special Assistant	Mangum,Larry C	2/28/2011	F	1	1	102170	0301	F	Reg	
KA11510000	Customer Service Clearinghouse	WRITER EDITOR	Lattimore,Jelani	4/22/2013	F	11	5	62291	1082	F	Term	
KA11510000	Customer Service Clearinghouse	Writer-Editor	Montgomery,Sonsyrea T.	1/28/2013	F	11	6	64065	1082	F	Term	
KA11511000	Customer Service Call Center	Customer Svs Communications Sp	Nobles,Aaron	5/4/2015	F	7	1	37927	0301	F	Reg	
KA11511000	Customer Service Call Center	Customer Svs Communications Sp	Saunders Sr.,Barry L	8/2/2010	F	7	7	45829	0301	F	Reg	
KA11511000	Customer Service Call Center	Customer Svs Communications Sp	Lilly,Kevin A	6/4/2012	F	7	3	40561	0301	F	Reg	
KA11511000	Customer Service Call Center	WRITER EDITOR			V	9	1	45811	1082	F	Reg	
KA11530000	Facilities Management	FACILITIES AND SPACE MGT SPEC	Hawkins,Ralph	1/20/1978	F	13	9	98863	0301	F	Reg	
KA11530000	Facilities Management	Maintenance Mechanic	Johnson Jr.,Hubert D.	10/14/2008	F	10	3	54745.6	4749	F	Reg	
KA11530000	Facilities Management	MAINTENANCE MECHANIC	Granberry,Gregory	7/15/2013	F	10	5	58323.2	4749	F	Term	
KA11530000	Facilities Management	Program Support Assistant (OA)	Freeman,Robyn	12/17/2012	F	7	4	41878	0303	F	Reg	
KA11530000	Facilities Management	Program Support Assistant (OA)	Daniel,Phillip	4/13/2009	F	7	5	43195	0303	F	Reg	
KA11530000	Facilities Management	Support Services Assistant	Lowe,Calvin	7/15/2013	F	5	2	34574	0303	F	Reg	
KA11530000	Facilities Management	Support Services Supervisor	Simmons,Gregory	7/10/2006	F	14	0	96756	0342	F	Reg	
KA11530000	Facilities Management	Support Services Supervisor			V	14	1	116107	0342	F	Reg	
KA11550000	Civil Rights	Americans with Disability Act	Barreto Vale,Cesar	1/27/2014	F	13	4	86253	0301	F	Reg	
KA11550000	Civil Rights	Deputy Compliance Officer	Gregory,Lisa M.	1/22/2008	F	14	0	114736.3	1801	F	Reg	
KA11550000	Civil Rights	Equal Employ. Opport. Special.	Nguyen,Luisa Beatriz	5/12/2008	F	12	4	74654	0260	F	Reg	
KA11550000	Civil Rights	Equal Opport. Compliance Spec.	Kabir,Mohammed Bazul	2/11/2013	F	12	3	72534	0360	F	Reg	
KA11550000	Civil Rights	Program Analyst	Randolph,Karen	1/12/2015	F	13	8	96341	0343	F	Reg	
KA11552000	EEO Team	Equal Employ. Opport. Special.	Stills,Leutisha	7/28/2014	F	12	2	70414	0260	F	Reg	
KA11552000	EEO Team	PROGRAM ANALYST	FENNELL,LINDA A	7/23/2007	F	13	6	91297	0343	F	Reg	
KA11560000	Human Capital Management	Cust Svc Communications Spec.	Pollard,Marcus T	6/4/2012	F	9	2	47275	0301	F	Reg	
KA11560000	Human Capital Management	Management Liaison Specialist	WALKER,CHARNITA B	10/26/2009	F	13	2	81209	0301	F	Reg	
KA11560000	Human Capital Management	Management Liaison Specialist	Perry,Sandra W.	10/31/2009	F	11	5	62291	0301	F	Reg	
KA11560000	Human Capital Management	OPERATIONS MGR	Messam,Steven E	5/7/2001	F	14	0	96756.2	0301	F	Reg	
KA11560000	Human Capital Management	Program Analyst	Winzor,Mallika	2/23/2004	F	13	5	88775	0343	F	Reg	
KA11560000	Human Capital Management	PROGRAM ANALYST	Patterson,Sharon	9/9/2013	F	11	3	58743	0343	F	Reg	
KA11560000	Human Capital Management	Program Analyst	Powell,Tanya	12/23/2007	F	12	5	76774	0343	F	Reg	
KA11560000	Human Capital Management	Program Analyst	Pettus,Angela L	5/15/1988	F	13	7	93819	9888	F	Reg	
KA11561000	Training	Cust Svc Communications Spec.	Price II,Joel M	8/2/2010	F	9	5	51667	0301	F	Reg	
KA11561000	Training	Program Specialist (Training)	Aiston,Charlotte C	2/17/1987	F	11	9	69387	0301	F	Reg	
KA11561000	Training	Program Support Assistant	Spencer,Tarita	10/30/2006	F	8	8	50937	0303	F	Reg	
KA11561000	Training	Program Support Assistant (OA)	Forgy,Nichole L	11/5/2001	F	7	9	52420	0303	F	Reg	
KA11561000	Training	Training & Organizational Deve	Lane-Hailey,Juliette	7/13/2015	F	14	0	100427	0301	F	Reg	
KA11561000	Training	Training & Organizational Deve			V	14	1	116107	0301	F	Reg	
KA11561000	Training	Training Specialist			V	12	1	68294	0301	F	Reg	
KA12000000	General Counsel	ATTORNEY ADVISOR	Dubin,Glenn	9/20/2004	F	15	4	138350	0905	F	Reg	
KA12000000	General Counsel	ATTORNEY ADVISOR	O'Connell,Michael Frances	2/10/2014	F	13	3	96516	0905	F	Term	

Department ID	Department Name	Job Title	Employee Name	Hire Date	Vacant / Filled Status	Grade	Step	Salary	Series	F/P Time	Reg/Term/Temp
KA14300000	Permits	Engineering Technician	Mosley,Michelle P	1/6/1980	F	12	6	85332	0802	F	Reg
KA14300000	Permits	Program Analyst	Jones,Shannon Renee	1/2/2007	F	12	6	78894	0343	F	Reg
KA14300000	Permits	PUBLIC SPACE COMMITTEE COOR	Felder,Catrina I	2/5/1989	F	12	7	87625	0301	F	Reg
KA14300000	Permits	PUBLIC SPACE MGR	Edwards,Bernadette	10/25/1986	F	14	0	106430.6	0301	F	Reg
KA14300000	Permits	STAFF ASSISTANT	Harris,Malinda G	5/22/2000	F	11	5	62291	0301	F	Reg
KA14300000	Permits	Surface Permitting Manager	Stokes,John	9/9/2013	F	13	0	84135.55	0301	F	Reg
KA14400000	Customer Service	Customer Svs Communications Sp	Martin,Kiana	4/21/2014	F	7	4	41878	0301	F	Reg
KA14400000	Customer Service	Customer Svs Communications Sp	Hall,Jennifer R	4/22/2013	F	7	2	39244	0301	F	Reg
KA14400000	Customer Service	Management Analyst	Green,Domanika	9/9/2013	F	12	2	70414	0343	F	Reg
KA14400000	Customer Service	Management Analyst	Doggett,Quartney R	10/4/2004	F	11	5	62291	0343	F	Reg
KA14400000	Customer Service	Outreach and Service Specialis	Wood,Brian	5/26/2015	F	12	3	72534	0301	F	Term
KA14400000	Customer Service	Program Support Assistant (OA)	Gorham,Juanita	1/12/2009	F	7	3	40561	0303	F	Reg
KA14400000	Customer Service	Program Support Assistant (OA)	Benson,Talat	11/19/2012	F	7	2	39244	0303	F	Reg
KA14400000	Customer Service	STAFF ASSISTANT	Grier,Pamela P	3/6/2005	F	11	4	60517	0301	F	Reg
KA14400000	Customer Service	Supv Mgmt and Program Analyst	Graham,Walter K.	5/27/2008	F	14	0	106521.8	0343	F	Reg
IPMA											
KA16000000	IPMA	Chief Engineer/Project Deliver			V	16	1	143009.5	801	F	Reg
KA16000000	IPMA	Civil Engineer	El-Hamri,Jamel	9/8/2014	F	11	3	63536	0810	F	Reg
KA16000000	IPMA	Civil Engineer	Williams II,Errol G	11/4/2013	F	12	5	83039	0810	F	Reg
KA16000000	IPMA	Civil Engineer	Chebli,Othman	8/12/2013	F	12	2	76160	0810	F	Reg
KA16000000	IPMA	Civil Engineer	Habtariam,Aklilu	7/2/2012	F	12	4	80746	0810	F	Reg
KA16000000	IPMA	COMM SPEC	Paul,Alberta L.	7/10/2006	F	13	7	101478	0301	F	Reg
KA16000000	IPMA	Environmental Program Supervis	Plano,Stephen	11/2/2015	F	14	0	120000	0301	F	Reg
KA16000000	IPMA	EQUAL OPPORTUNITY SPEC	Rouillier,Brett J	7/24/1978	F	13	8	96341	0360	F	Reg
KA16000000	IPMA	Landscape Architect			V	13	1	78687	807	F	Reg
KA16000000	IPMA	Program Analyst	Brogden,Troy	6/28/2004	F	13	10	101385	0343	F	Reg
KA16000000	IPMA	Program Analyst	Bembry,Jessica I	12/8/2008	F	12	2	70414	0343	F	Reg
KA16000000	IPMA	Public Space Coordinator	Fulton,Thomas E	11/13/2006	F	12	7	87625	0301	F	Reg
KA16000000	IPMA	Right of Way Program Coordinat	Duel,John	10/6/2014	F	14	2	95979	0301	F	Reg
KA16000000	IPMA	STAFF ASSISTANT	Washington,Theresa A	4/13/1987	F	11	7	65839	0301	F	Reg
KA16000000	IPMA	STAFF ASSISTANT	Nichols,Monique	11/23/1998	F	11	5	62291	0301	F	Reg
KA16000000	IPMA	STAFF ASST	Hymes,Kristy L	9/24/2001	F	11	7	65839	0301	F	Reg
KA16000000	IPMA	Supervisory Civil Engineer	Muluneh,Dawit G	10/22/2001	F	16	0	142322.1	0810	F	Reg
KA16000000	IPMA	Supervisory Civil Engineer	Ganvir,Ravindra	7/18/2011	F	16	0	144200	0810	F	Reg
KA16000000	IPMA	Supv Civil Engineer	Foxx,Keith	3/26/2012	F	15	0	132453.4	0810	F	Reg
KA16000000	IPMA	Supv Civil Engineer			V	15	1	128879	0810	F	Reg
KA16000000	IPMA	SUPV GEN ENGINEER	Udeh,Maduabuchi L	7/3/1989	F	14	0	110516.6	0801	F	Reg
KA16000000	IPMA	Supvy Civil Engineer	Simie,Ejigineh	9/9/2002	F	14	0	110422.7	0810	F	Reg
KA16000000	IPMA	Supvy Civil Engineer	Dickerson,Clarence L.	11/14/2005	F	14	0	103966.4	0810	F	Reg
KA16000000	IPMA	Supvy Civil Engineer	Bozkurt,Diyar	6/15/2015	F	14	0	123600	0810	F	Reg
KA16000000	IPMA	Transportation Spec (Traff Op)	Robinson,Elijah	3/5/1984	F	13	6	98749	2101	F	Reg
KA16100000	Design & Project Management Di	Interim Deputy Chief Transport			V	15	0	128879	801	F	Reg
KA16101000	Anacostia Waterfront Initiati	Civil Engineer	Eskender,Konjit	10/22/2001	F	14	7	119923	0810	F	Reg
KA16101000	Anacostia Waterfront Initiati	CIVIL ENGINEER	D'Arbela,Denis	12/22/2008	F	12	10	94504	0810	F	Reg
KA16101000	Anacostia Waterfront Initiati	Civil Engineer	Asfaw,Etayenesh	12/1/2014	F	12	6	85332	0810	F	Reg
KA16101000	Anacostia Waterfront Initiati	CIVIL ENGINEER	Okechukwu,Alexander O	11/10/2008	F	12	9	92211	0810	F	Reg
KA16101000	Anacostia Waterfront Initiati	CIVIL ENGINEER	Dorsey,Joseph D	5/12/2008	F	13	6	98749	0810	F	Reg
KA16101000	Anacostia Waterfront Initiati	CIVIL ENGINEER	Oladokun,Abiodun Adedayo	4/8/2002	F	12	7	87625	0810	F	Reg
KA16101000	Anacostia Waterfront Initiati	Engineering Tech. (Civil)	Johnson,Damon S	1/19/2000	F	11	7	71212	0802	F	Reg
KA16101000	Anacostia Waterfront Initiati	Engineering Tech. (Civil)	Fields,Lacrecia	1/31/2000	F	11	7	71212	0802	F	Reg
KA16101000	Anacostia Waterfront Initiati	Engineering Tech. (Civil)	Lowery,Clifford J	5/31/2012	F	11	9	75050	0802	F	Reg
KA16101000	Anacostia Waterfront Initiati	Supv Civil Engineer	Lytle,Delmar	9/8/2014	F	15	0	143221.5	0810	F	Reg
KA16101000	Anacostia Waterfront Initiati	Supvy Civil Engineer			V	14	1	116107	0810	F	Reg
KA16101000	Anacostia Waterfront Initiati	Transportation Spec (Traff Op)	Cloyd,Ra'Adia K	6/3/2002	F	13	3	90562	2101	F	Reg
KA16102000	Storm Water Management Branch	Civil Engineer	Nunez,Danilo	9/8/2015	F	12	1	73867	0810	F	Term
KA16102000	Storm Water Management Branch	Civil Engineer	Pike,Julie	1/25/2016	F	12	2	76160	0810	F	Term
KA16102000	Storm Water Management Branch	Civil Engineer	Tekle,Tesfalem	2/8/2016	F	12	1	73867	0810	F	Term
KA16102000	Storm Water Management Branch	Landscape Architect	Upchurch,Meredith C	9/2/2008	F	13	7	93819	0807	F	Reg
KA16110000	Asset Management Analysis Divi	CIVIL ENGINEER	Rennie,Simon A	5/27/1986	F	14	10	119811	0810	F	Reg
KA16110000	Asset Management Analysis Divi	CIVIL ENGINEER	Matharu,Jaswant S	4/27/1998	F	13	7	101478	0810	F	Reg
KA16110000	Asset Management Analysis Divi	CIVIL ENGINEER	Carpenter,Edward A	10/10/2000	F	13	7	101478	0810	F	Reg
KA16110000	Asset Management Analysis Divi	CIVIL ENGINEER	Toyer,Delante T	10/15/1982	F	12	8	89918	0810	F	Reg
KA16110000	Asset Management Analysis Divi	CIVIL ENGINEER	Makonnen,Wolde M	9/8/2003	F	13	8	104207	0810	F	Reg
KA16110000	Asset Management Analysis Divi	CIVIL ENGINEER			V	13	1	85104	0810	F	Reg
KA16110000	Asset Management Analysis Divi	Engineering Tech. (Civil)	Moon,Adrian S	12/10/2007	F	9	2	51134	0802	F	Reg
KA16110000	Asset Management Analysis Divi	Engineering Tech. (Civil)	Arno,Tianeka P	4/24/2000	F	11	6	69293	0802	F	Reg
KA16110000	Asset Management Analysis Divi	Engineering Tech. (Civil)	Horton Jr.,Robert J	4/3/1983	F	11	10	76969	0802	F	Reg
KA16110000	Asset Management Analysis Divi	Supv Civil Engineer	Horton,Aaron	5/3/2004	F	15	0	126367.3	0810	F	Reg
KA16110000	Asset Management Analysis Divi	Supvy Civil Engineer	Tesfaye,Yared	7/26/2004	F	14	0	120632	0810	F	Reg
KA16111000	Bridge and Tunnel Branch	CIVIL ENGINEER	Cole,Herman E	11/27/2006	F	13	7	101478	0810	F	Reg
KA16111000	Bridge and Tunnel Branch	STRUCTURAL ENGINEER	Cooney,L Donald	12/23/1966	F	14	10	129592	0810	F	Reg
KA16120000	Team 1	CIVIL ENGINEER	Sellers,James O	8/27/1973	F	13	10	109665	0802	F	Reg
KA16120000	Team 1	CIVIL ENGINEER	Ayeva,Kadijatou	12/24/2007	F	12	6	85332	0810	F	Reg
KA16120000	Team 1	Civil Engineer	Ohlson P.E,Kyle N.	4/23/2012	F	13	3	90562	0810	F	Reg
KA16120000	Team 1	CIVIL ENGINEER	Ayodele,Samuel O	4/26/1989	F	13	8	104207	0810	F	Reg
KA16120000	Team 1	Civil Engineer	Rizvi,Mohammed A	9/24/2012	F	13	8	104207	0810	F	Reg
KA16120000	Team 1	Civil Engineer	Sarabi,Aidin Rezaei	12/17/2012	F	12	2	76160	0810	F	Reg
KA16120000	Team 1	CUSTOMER SERVICE COMM SPEC			V	9	1	45811	0301	F	Reg
KA16120000	Team 1	Engineering Tech. (Civil)	Hackney,Jerome G	5/1/1985	F	11	8	73131	0802	F	Reg
KA16120000	Team 1	Engineering Tech. (Civil)	Burns,Kevin C	1/16/1990	F	11	10	76969	0802	F	Reg
KA16120000	Team 1	Engineering Tech. (Civil)	Prince,Maurice	5/11/1998	F	11	8	73131	0802	F	Reg
KA16120000	Team 1	HIGHWAY ENGINEER	Agahi,Ghulam A	10/5/1981	F	13	10	109665	0810	F	Reg
KA16120000	Team 1	STAFF ASSISTANT	Brown,Tarifa M	3/19/2007	F	11	2	56969	0301	F	Reg
KA16120000	Team 1	Supervisory Civil Engineer	Peckham,Wendy L	10/24/2011	F	15	0	107398.7	0810	F	Reg
KA16120000	Team 1	Supv Civil Engineer	Kenney Jr.,Richard William	7/16/2012	F	15	0	141836.2	0810	F	Reg
KA16120000	Team 1	SUPV CIVIL ENGINEER	Clabaugh,Mark R	3/31/2008	F	13	0	117789.4	0810	F	Reg
KA16121000	Federal Bridge Project	ELECTRICAL ENGINEER	Rasson,Rahmat	1/7/1985	F	13	9	106936	0850	F	Reg
KA16121000	Federal Bridge Project	Engineering Tech. (Civil)	Hugh,Mandy M	4/27/1998	F	11	10	76969	0802	F	Reg
KA16123000	Local Roadway Projects	CIVIL ENGINEER	Mirchandani,Ramesh	2/3/1990	F	13	10	109665	0810	F	Reg
KA16123000	Local Roadway Projects	CIVIL ENGINEER	Jamabo,Deinma Adolphus	2/26/1990	F	13	9	106936	0810	F	Reg
KA16123000	Local Roadway Projects	SUPVY CIVIL ENGINEER	Olaore,Olusegun	8/25/2003	F	13	0	92317.95	0810	F	Reg
KA16130000	Team 2	CIVIL ENGINEER	Wilson,Wayne Kamaya	9/8/2003	F	12	8	89918	0810	F	Reg
KA16130000	Team 2	Civil Engineer	Tesfamichael,Ghirmay Sibhatleab	5/6/2013	F	12	3	78453	0810	F	Reg
KA16130000	Team 2	CIVIL ENGINEER	Freeman,Stanley Z	3/13/1989	F	13	8	104207	0810	F	Reg

Department ID	Department Name	Job Title	Employee Name	Hire Date	Vacant / Filled Status	Grade	Step	Salary	Series	F/P Time	Reg/Temp/Term
KA18130000	Policy Branch	TRANSPORTATION PLANNER	Rogers,Jonathan M.	4/23/2012	F	12	6	78894	2101	F	Reg
KA18130000	Policy Branch	Transportation Planner (Prkg.)	Dastgheib,Fakhteh	1/12/2015	F	13	7	93819	9888	F	Reg
KA18200000	Strategic Planning Branch	Supvy Transp. Mgmt Planner	Henson,Jamie	3/16/2009	F	14	0	103333	2150	F	Reg
KA18200000	Strategic Planning Branch	Trans Planner (Citywide)	Westrom,Ryan	7/28/2014	F	14	8	113853	2101	F	Reg
KA18200000	Strategic Planning Branch	Trans Planner (Citywide)	Chamberlin,Anna C.	7/23/2007	F	14	2	95979	2101	F	Reg
KA18200000	Strategic Planning Branch	TRANSPORTATION PLANNER	Booker,Lewis C	12/4/2000	F	12	7	81014	2101	F	Reg
KA18200000	Strategic Planning Branch	TRANSPORTATION PLANNER	Israel,Evelyn Jesse	6/17/2013	F	13	3	83731	2101	F	Reg
KA18200000	Strategic Planning Branch	TRANSPORTATION PLANNER	Rogers,Jonathan D.	3/11/2013	F	13	3	83731	2101	F	Reg
KA18210000	Community & Development Review	Supvy Transp. Mgmt Planner	Hawkinson,Colleen Smith	8/5/2002	F	14	0	115407.3	2150	F	Reg
KA18210000	Community & Development Review	TRANSPORTATION PLANNER	Kanagy,Megan R	1/26/2015	F	13	5	88775	2101	F	Reg
KA18210000	Community & Development Review	TRANSPORTATION PLANNER	Onyeador,Gabriel O	5/11/2009	F	13	5	88775	2101	F	Reg
KA18210000	Community & Development Review	TRANSPORTATION PLANNER	Rice,Stephen	10/31/2005	F	13	5	88775	2101	F	Reg
KA18210000	Community & Development Review	TRANSPORTATION PLANNER	Peterson,Kelly E.	5/7/2012	F	13	3	83731	2101	F	Reg
KA18210000	Community & Development Review	TRANSPORTATION PLANNER	Van Houten,Theodore J	1/27/2014	F	12	2	70414	2101	F	Reg
KA18210000	Community & Development Review	TRANSPORTATION PLANNER			V	13	1	78687	2101	F	Reg
KA18300000	Plan Review & Compliance Divis	Bicycle Program Specialist	Alvino,Michael	11/2/2015	F	12	3	72534	0301	F	Reg
KA18300000	Plan Review & Compliance Divis	Bicycle/Pedestrian Program Spe	Buck,Darren	1/13/2014	F	13	7	93819	0301	F	Reg
KA18300000	Plan Review & Compliance Divis	Supvy Transp. Mgmt Planner	Sebastian,James R	4/9/2001	F	14	0	108180	2150	F	Reg
KA18300000	Plan Review & Compliance Divis	Transportation Equity and Incl			V	15	1	128879	0301	F	Reg
KA18300000	Plan Review & Compliance Divis	Transportation Special Project	Bazile,Reginald P	9/4/2007	F	15	0	139287.7	2101	F	Reg
KA18320000	State Planning Branch	Supvy Transp. Mgmt Planner			V	14	1	116107	2150	F	Reg
KA18320000	State Planning Branch	TRANSPORTATION PLANNER	Richards,Laura	12/2/2013	F	12	3	72534	2101	F	Reg
KA18320000	State Planning Branch	TRANSPORTATION PLANNER	Solano Jr.,Gilberto E.	8/6/2007	F	12	10	87374	2101	F	Reg
KA18320000	State Planning Branch	Transportation Planner	Peterson,Jamesshia	11/18/2013	F	11	5	62291	2101	F	Reg
KA18320000	State Planning Branch	Transportation Planner (Region	Rawlings,Mark D	10/2/2006	F	14	8	113853	2101	F	Reg
KA18320000	State Planning Branch	Transportation Program Spec	Bell,Deneane E	11/6/1989	F	13	7	93819	2101	F	Reg
KA18320000	State Planning Branch	Transportation Specialist	BETHEA,HOWARD	7/23/2007	F	11	8	73131	2101	F	Reg
KA18321000	Highway Safety, Research & Tec	Supervisory Highway Safety Spe	Lewis,Carole A	10/26/1963	F	14	0	119707.2	2125	F	Reg
KA18321000	Highway Safety, Research & Tec	Transportation Management Spec	Gay,Karen M	11/12/1985	F	12	7	81014	2150	F	Reg
KA18321000	Highway Safety, Research & Tec	TRANSPORTATION PLANNER	Dock,Stephanie Pecore	6/4/2012	F	13	2	81209	2101	F	Reg
KA18330000	Compliance Branch	ENVIRONMENT PGM COOR			V	14	1	93000	0301	F	Reg
TOA											
KA19000000	TOA	Deputy Associate Director for	Marsili Jr.,Robert L	3/21/2005	F	15	0	143142.2	0301	F	Reg
KA19000000	TOA	Deputy Associate Director for			V	15	1	128879	0301	F	Reg
KA19000000	TOA	Supvy. Inventory Management Sp	Bulluck,Adrian	8/23/2013	F	12	0	73161.79	2010	F	Reg
KA19010000	Office of the Associate Direct	Chief Operations Officer	Robinson,Suzette	11/2/2015	F	16	0	155000	0301	F	Reg
KA19010000	Office of the Associate Direct	Program Support Assistant (OA)	Grant-Jones,Sterling	11/19/2012	F	7	7	45829	0303	F	Reg
KA19100000	Transportation Operations Divi	Electronic Mechanic	Patrick,Eugene P	10/31/2009	F	11	8	66892.8	2604	F	Reg
KA19100000	Transportation Operations Divi	Engineering Tech. (Electrical)	Hall,Monroe D.	10/17/2005	F	12	7	87625	0802	F	Reg
KA19100000	Transportation Operations Divi	Management Analyst	Maclin,Rashele A.	2/19/2008	F	12	2	70414	0343	F	Reg
KA19100000	Transportation Operations Divi	Program Analyst			V	12	1	68294	0343	F	Reg
KA19100000	Transportation Operations Divi	SUPERVISORY GENERAL ENGINEER	Cheeks,James	11/24/2008	F	15	0	125600.2	0801	F	Reg
KA19100000	Transportation Operations Divi	SUPV GEN ENGINEER	Raja,Ahmed W	2/16/2010	F	14	0	135457.7	0801	F	Reg
KA19100000	Transportation Operations Divi	Supv Traffic Operations Mngr,			V	14	0	116107	0301	F	Reg
KA19100000	Transportation Operations Divi	Transportation Engineer	Hailemariam,Brook A	4/3/2006	F	13	7	101478	0801	F	Reg
KA19100000	Transportation Operations Divi	Transportation Engineer	Tao,Xiangding	4/30/2006	F	13	10	109665	0801	F	Reg
KA19110000	Transportation Management Cent	Lead Traffic System Oper	Roscoe,Phyllis Y	6/24/2002	F	9	10	63798	0392	F	Reg
KA19110000	Transportation Management Cent	Lead Traffic System Oper	Mcphaul Jenkins,Angela D	8/15/1988	F	9	8	60632	0392	F	Reg
KA19110000	Transportation Management Cent	Lead Traffic System Oper	Ware Jr.,Lawrence J	11/17/2003	F	9	6	57466	0392	F	Reg
KA19110000	Transportation Management Cent	Lead Traffic System Oper	Akopian,Edward	7/29/2002	F	9	10	63798	0392	F	Reg
KA19110000	Transportation Management Cent	Lead Traffic System Oper	Bailey,Leslie M	6/24/2002	F	9	7	59049	0392	F	Reg
KA19110000	Transportation Management Cent	Program Analyst	Pree,Melony A	12/26/2006	F	12	2	70414	0343	F	Reg
KA19110000	Transportation Management Cent	Program Analyst	Winfield,Vanessa	1/22/2007	F	13	6	91297	0343	F	Reg
KA19110000	Transportation Management Cent	Supervisory Transportation Ass	Brown,Victor C.	7/21/2008	F	10	9	63148	2102	F	Reg
KA19110000	Transportation Management Cent	Supervisory Transportation Ass	Barksdale,Carlos	5/15/2006	F	10	5	56704	2102	F	Reg
KA19110000	Transportation Management Cent	SUPV ENGINEERING TECH	Chaudhry,Zahid	12/2/2013	F	12	0	73161.79	0802	F	Reg
KA19110000	Transportation Management Cent	TRAFFIC SYSTEM OPERATOR	Outing,Raytessha C	6/16/2003	F	8	7	53657	0392	F	Reg
KA19110000	Transportation Management Cent	TRAFFIC SYSTEM OPERATOR	Wooten,Nicole M	3/23/1999	F	8	8	55092	0392	F	Reg
KA19110000	Transportation Management Cent	TRAFFIC SYSTEM OPERATOR	Green,Nillea D	2/19/2008	F	8	10	57962	0392	F	Reg
KA19110000	Transportation Management Cent	TRAFFIC SYSTEM OPERATOR	Waddy,Leon E	1/14/2013	F	8	3	47917	0392	F	Reg
KA19110000	Transportation Management Cent	TRAFFIC SYSTEM OPERATOR	Brandon,Jasmine D	7/29/2002	F	8	8	55092	0392	F	Reg
KA19110000	Transportation Management Cent	TRAFFIC SYSTEM OPERATOR	Lewis,Malcolm A	11/5/2012	F	8	4	49352	0392	F	Reg
KA19110000	Transportation Management Cent	TRAFFIC SYSTEM OPERATOR	Williams,Algermon R	11/5/2012	F	8	4	49352	0392	F	Reg
KA19110000	Transportation Management Cent	TRAFFIC SYSTEM OPERATOR	Turner,Benjamin	1/22/2008	F	8	6	52222	0392	F	Reg
KA19110000	Transportation Management Cent	Transpor Asst (RO/MVO)	James,Kevin L	10/3/2005	F	8	7	53657	2102	F	Reg
KA19120000	Roadway Operations Branch	MOTOR VEHICLE OPERATOR	Fields,Warren L.	10/1/2007	F	8	7	56014.4	5703	F	Reg
KA19120000	Roadway Operations Branch	SUPV ENGINEERING TECH			V	12	1	56050	0802	F	Reg
KA19120000	Roadway Operations Branch	Transpor Asst (RO/MVO)			V	7	1	41020	2102	F	Reg
KA19120000	Roadway Operations Branch	Transpor Asst (RO/MVO)	Honesty-Bey,Chief	2/19/2008	F	8	10	57962	2102	F	Reg
KA19120000	Roadway Operations Branch	Transpor Asst (RO/MVO)	Skeen,Tyrone	12/10/2007	F	8	5	50787	2102	F	Reg
KA19120000	Roadway Operations Branch	Transpor Asst (RO/MVO)	Mccrea,Donna J	4/23/2001	F	8	9	56527	2102	F	Reg
KA19120000	Roadway Operations Branch	Transpor Asst (RO/MVO)	Mason,Bradley Leon	3/6/2006	F	8	7	53657	2102	F	Reg
KA19120000	Roadway Operations Branch	Transpor Asst (RO/MVO)	Makle Jr.,Albert B.	9/24/2012	F	8	4	49352	2102	F	Reg
KA19120000	Roadway Operations Branch	Transpor Asst (RO/MVO)	Brooks,Kevin L	2/19/2008	F	8	10	57962	2102	F	Reg
KA19120000	Roadway Operations Branch	Transpor Asst (RO/MVO)	Warren,Darren R	10/14/2008	F	8	3	47917	2102	F	Reg
KA19120000	Roadway Operations Branch	Transpor Asst (RO/MVO)	Wilson,Jeremy B.	2/5/2007	F	8	8	55092	2102	F	Reg
KA19120000	Roadway Operations Branch	Transpor Asst (RO/MVO)	Shannon,Eric A	4/23/2012	F	8	3	47917	2102	F	Reg
KA19120000	Roadway Operations Branch	Transpor Asst (RO/MVO)	Riley,Sigbee D	10/1/2007	F	8	9	56527	2102	F	Reg
KA19120000	Roadway Operations Branch	Transpor Asst (RO/MVO)	Hardy Jr.,Willie A	8/4/2008	F	8	5	50787	2102	F	Reg
KA19130000	Traffic Control Officers & Sch	Management Analyst	Young,Danielle T	10/30/2006	F	12	3	72534	0343	F	Reg
KA19130000	Traffic Control Officers & Sch	STAFF ASSISTANT	Davis Thomas,Jacquelyn	5/13/1985	F	11	7	65839	0301	F	Reg
KA19130000	Traffic Control Officers & Sch	Supvy Traffic Control Officer	Thweatt,Dena R	5/6/2002	F	12	0	80478.81	2101	F	Reg
KA19130000	Traffic Control Officers & Sch	Traffic Control Officer	Ramirez,Roberto	1/27/2014	F	7	3	43870	2101	F	Term
KA19130000	Traffic Control Officers & Sch	Traffic Control Officer	Butler,Sarah	10/27/2008	F	9	2	51134	2101	F	Reg
KA19130000	Traffic Control Officers & Sch	Traffic Control Officer	Burns,Ceray	1/13/2014	F	7	3	43870	2101	F	Term
KA19130000	Traffic Control Officers & Sch	Traffic Control Officer	Ellis,Geneva E	10/14/2008	F	9	5	55883	2101	F	Reg
KA19130000	Traffic Control Officers & Sch	Traffic Control Officer	Dial,Lamont	7/29/2013	F	7	3	43870	2101	F	Reg
KA19130000	Traffic Control Officers & Sch	Traffic Control Officer	Morgan,Kenita N	1/12/2009	F	9	3	52717	2101	F	Reg
KA19131000	Traffic Control Officers Progr	Community Engagement Director			V	7	1	98482	0301	F	Reg
KA19131000	Traffic Control Officers Progr	Lead Traffic Control Officer	Chase,Joyce H	9/7/2004	F	11	5	62291	2101	F	Reg
KA19131000	Traffic Control Officers Progr	Lead Traffic Control Officer	Dearing,Michele V	10/18/2011	F	11	2	56969	2101	F	Reg
KA19131000	Traffic Control Officers Progr	Lead Traffic Control Officer	Graves,Jermont D	5/20/2013	F	11	1	55195	2101	F	Reg
KA19131000	Traffic Control Officers Progr	PARKING & TRAFFIC ENFR OFR	Kollie,George S	7/26/2008	F	9	7	59049	1801	F	Reg
KA19131000	Traffic Control Officers Progr	Supervisory Traffic Control Of	Hall,Michael D	8/16/2010	F	11	0	62001.12	2101	F	Reg

Department ID	Department Name	Job Title	Employee Name	Hire Date	Vacant / Filled Status	Grade	Step	Salary	Series	F/P Time	Reg/Term/Temp
KA19131000	Traffic Control Officers Progr	Supervisory Traffic Control Of	Wren-Perkins,Nettina C	3/27/2000	F	11	0	62001.12	2101	F	Reg
KA19131000	Traffic Control Officers Progr	Supervisory Traffic Control Of	Godfrey,Jason G	5/10/2010	F	11	0	68958.5	2101	F	Reg
KA19131000	Traffic Control Officers Progr	Supvy Traffic Control Officer	Morris Matthews,Kathryn M	2/14/2011	F	12	0	73161.93	2101	F	Reg
KA19131000	Traffic Control Officers Progr	Traffic Control Officer	Russell,Gail H	7/19/2010	F	9	2	51134	2101	F	Reg
KA19131000	Traffic Control Officers Progr	Traffic Control Officer	Tillman,Darnell P	7/19/2010	F	9	2	51134	2101	F	Reg
KA19131000	Traffic Control Officers Progr	Traffic Control Officer	Mattox Jr.,Anthony C	3/2/2009	F	9	2	51134	2101	F	Reg
KA19131000	Traffic Control Officers Progr	Traffic Control Officer	Davis,Ronetta	6/11/2001	F	9	7	59049	2101	F	Reg
KA19131000	Traffic Control Officers Progr	Traffic Control Officer	Rosario,Yunior	6/29/2015	F	7	1	41020	2101	F	Reg
KA19131000	Traffic Control Officers Progr	Traffic Control Officer	McIntyre,Lamar	6/29/2015	F	7	1	41020	2101	F	Reg
KA19131000	Traffic Control Officers Progr	Traffic Control Officer	Hargrove,Robert E	11/19/2012	F	9	2	51134	2101	F	Reg
KA19131000	Traffic Control Officers Progr	Traffic Control Officer	Graham,LaQuanta	11/10/2008	F	9	3	52717	2101	F	Reg
KA19131000	Traffic Control Officers Progr	Traffic Control Officer	Johnson,Pamela A	8/18/2008	F	9	3	52717	2101	F	Reg
KA19131000	Traffic Control Officers Progr	Traffic Control Officer	Graham,Marcus	12/31/2012	F	9	2	51134	2101	F	Reg
KA19131000	Traffic Control Officers Progr	Traffic Control Officer	Gray,Yetta F	10/14/2008	F	9	2	51134	2101	F	Reg
KA19131000	Traffic Control Officers Progr	Traffic Control Officer	Baumgardner,Arielle	3/11/2013	F	9	2	51134	2101	F	Reg
KA19131000	Traffic Control Officers Progr	Traffic Control Officer	Morton,Deborah J	9/22/1996	F	9	7	59049	2101	F	Reg
KA19131000	Traffic Control Officers Progr	Traffic Control Officer	Robinson,Timothy E	7/15/2002	F	9	7	59049	2101	F	Reg
KA19131000	Traffic Control Officers Progr	Traffic Control Officer	Jones,Tywan	2/4/2008	F	9	9	62215	2101	F	Reg
KA19131000	Traffic Control Officers Progr	Traffic Control Officer	Nickelson,Charlotte J	8/26/2013	F	7	3	43870	2101	F	Reg
KA19131000	Traffic Control Officers Progr	Traffic Control Officer	Cato,Preston L	9/12/1988	F	9	8	60632	2101	F	Reg
KA19131000	Traffic Control Officers Progr	Traffic Control Officer	Franks-Dunbar,Sharon	11/23/2009	F	9	2	51134	2101	F	Term
KA19131000	Traffic Control Officers Progr	Traffic Control Officer	Dennis,Wayne	2/10/2014	F	7	2	42445	2101	F	Term
KA19131000	Traffic Control Officers Progr	Traffic Control Officer	Adkins,Tionna	12/30/2013	F	7	3	43870	2101	F	Term
KA19131000	Traffic Control Officers Progr	Traffic Control Officer	Harris,Milicent	9/2/2008	F	9	3	52717	2101	F	Reg
KA19131000	Traffic Control Officers Progr	Traffic Control Officer	Summers,Cheryl D	2/29/1988	F	9	3	52717	2101	F	Reg
KA19131000	Traffic Control Officers Progr	Traffic Control Officer	Tolbert,Tasha	12/30/2013	F	7	3	43870	2101	F	Term
KA19131000	Traffic Control Officers Progr	Traffic Control Officer	Mccane,Deirdre M	1/11/2016	F	7	4	45295	2101	F	Reg
KA19131000	Traffic Control Officers Progr	Traffic Control Officer	Boardley,Ramona J	3/3/2008	F	9	1	49551	2101	F	Term
KA19131000	Traffic Control Officers Progr	Traffic Control Officer	Lancaster,Anthony L	7/14/2003	F	9	7	59049	2101	F	Reg
KA19131000	Traffic Control Officers Progr	Traffic Control Officer	Mobley,Monique A	7/1/2002	F	9	7	59049	2101	F	Reg
KA19131000	Traffic Control Officers Progr	Traffic Control Officer	Hailey,Shanika C	6/16/2003	F	9	7	59049	2101	F	Reg
KA19131000	Traffic Control Officers Progr	Traffic Control Officer	Ellington,Tracey K	5/20/2002	F	9	7	59049	2101	F	Reg
KA19131000	Traffic Control Officers Progr	Traffic Control Officer	Britton,Coneice J	6/17/2002	F	9	7	59049	2101	F	Reg
KA19131000	Traffic Control Officers Progr	Traffic Control Officer	Wise,Michael	12/10/2007	F	9	5	55883	2101	F	Reg
KA19131000	Traffic Control Officers Progr	Traffic Control Officer	Dyson,Dimitri	9/10/2012	F	9	2	51134	2101	F	Term
KA19131000	Traffic Control Officers Progr	Traffic Control Officer	Tolson,Sharon L	9/22/2014	F	7	5	46720	2101	F	Term
KA19131000	Traffic Control Officers Progr	Traffic Control Officer	Claggett,Delonte	12/30/2013	F	7	3	43870	2101	F	Term
KA19131000	Traffic Control Officers Progr	Traffic Control Officer	Smith,Bianca	12/3/2012	F	9	2	51134	2101	F	Reg
KA19131000	Traffic Control Officers Progr	Traffic Control Officer	Watkins,Lorrice A	10/24/2011	F	9	2	51134	2101	F	Reg
KA19131000	Traffic Control Officers Progr	Traffic Control Officer	Green,Angelina L	5/20/2002	F	9	7	59049	2101	F	Reg
KA19131000	Traffic Control Officers Progr	Traffic Control Officer	Daniel,Isaiah	1/13/2014	F	7	3	43870	2101	F	Term
KA19131000	Traffic Control Officers Progr	Traffic Control Officer	Johnson,Janita	1/2/2007	F	9	2	51134	2101	F	Reg
KA19131000	Traffic Control Officers Progr	Traffic Control Officer	Perez,Neuris	12/31/2012	F	9	2	51134	2101	F	Reg
KA19131000	Traffic Control Officers Progr	Traffic Control Officer	Porter,Gina	8/22/2005	F	9	2	51134	2101	F	Reg
KA19131000	Traffic Control Officers Progr	Traffic Control Officer	Blanding,Ashley N	6/3/2002	F	9	6	57466	2101	F	Reg
KA19131000	Traffic Control Officers Progr	Traffic Control Officer	Brooks,Shaheda	8/2/2010	F	9	2	51134	2101	F	Reg
KA19131000	Traffic Control Officers Progr	Traffic Control Officer	Butler,Kemeisha A	8/18/2008	F	9	5	55883	2101	F	Reg
KA19131000	Traffic Control Officers Progr	Traffic Control Officer	Johnson,Marques J	9/13/2010	F	9	5	55883	2101	F	Reg
KA19131000	Traffic Control Officers Progr	Traffic Control Officer	Bailey,Tyreesse M	3/11/2002	F	9	7	59049	2101	F	Reg
KA19131000	Traffic Control Officers Progr	Traffic Control Officer	Fleming,Janet L	4/15/1996	F	9	7	59049	2101	F	Reg
KA19131000	Traffic Control Officers Progr	Traffic Control Officer	Owens,Andre	8/25/2014	F	9	2	51134	2101	F	Term
KA19131000	Traffic Control Officers Progr	Traffic Control Officer	Addison,Ethel N	5/10/1999	F	9	7	59049	2101	F	Reg
KA19131000	Traffic Control Officers Progr	Traffic Control Officer	Barnes,Jerome	9/22/2014	F	7	2	42445	2101	F	Term
KA19131000	Traffic Control Officers Progr	Traffic Control Officer	Donaldson,David D	6/2/2014	F	7	2	42445	2101	F	Term
KA19131000	Traffic Control Officers Progr	Traffic Control Officer	Ford,Rayshawn	1/13/2014	F	7	3	43870	2101	F	Term
KA19131000	Traffic Control Officers Progr	Traffic Control Officer	Jones,Derrick C	8/8/2009	F	9	7	59049	2101	F	Reg
KA19131000	Traffic Control Officers Progr	Traffic Control Officer	Reeder,Darlene E	10/14/2008	F	9	2	51134	2101	F	Reg
KA19131000	Traffic Control Officers Progr	Traffic Control Officer	Johnson,Wendell R	8/25/2014	F	7	2	42445	2101	F	Term
KA19131000	Traffic Control Officers Progr	Traffic Control Officer	Haggins Jr., Arpell	8/2/2010	F	9	2	51134	2101	F	Reg
KA19131000	Traffic Control Officers Progr	Traffic Control Officer	Hill,Gregory C.	7/27/2015	F	7	1	41020	2101	F	Reg
KA19131000	Traffic Control Officers Progr	Traffic Control Officer	Walker,Ameka L	12/19/2011	F	9	2	51134	2101	F	Reg
KA19131000	Traffic Control Officers Progr	Traffic Control Officer	Walker,Glen A	10/25/2010	F	9	3	52717	2101	F	Reg
KA19131000	Traffic Control Officers Progr	Traffic Control Officer	Ward,Vernard	12/10/2013	F	9	7	59049	2101	F	Reg
KA19131000	Traffic Control Officers Progr	Traffic Control Officer	Moon,Devon	9/15/2008	F	9	5	55883	2101	F	Reg
KA19131000	Traffic Control Officers Progr	Traffic Control Officer	Weaver,Lawrence A	2/17/2009	F	9	5	55883	2101	F	Reg
KA19131000	Traffic Control Officers Progr	Traffic Control Officer	Laster,Ronnie J	8/2/2010	F	9	3	52717	2101	F	Reg
KA19131000	Traffic Control Officers Progr	Traffic Control Officer	Wilson,LaShawn N	10/27/2008	F	7	3	43870	2101	F	Term
KA19131000	Traffic Control Officers Progr	Traffic Control Officer	Hoyle,Robert Barry	7/27/2015	F	7	1	41020	2101	F	Reg
KA19131000	Traffic Control Officers Progr	Traffic Control Officer	West,Traci D	2/25/2002	F	9	6	57466	2101	F	Reg
KA19131000	Traffic Control Officers Progr	Traffic Control Officer	Watkins,Kendra A	5/6/2002	F	9	6	57466	2101	F	Reg
KA19131000	Traffic Control Officers Progr	Traffic Control Officer	Fields,Amber Marie	11/5/2012	F	9	2	51134	2101	F	Reg
KA19131000	Traffic Control Officers Progr	Traffic Control Officer	Tapp,Merika L	10/22/2001	F	9	6	57466	2101	F	Reg
KA19131000	Traffic Control Officers Progr	Traffic Control Officer	Wheatley,Marvaughn	7/27/2015	F	7	1	41020	2101	F	Reg
KA19131000	Traffic Control Officers Progr	Traffic Control Officer	Schools,Akia	4/22/2013	F	9	2	51134	2101	F	Reg
KA19131000	Traffic Control Officers Progr	Traffic Control Officer	Beeks,Wanda	8/2/2010	F	9	2	51134	2101	F	Reg
KA19131000	Traffic Control Officers Progr	Traffic Control Officer	Bell,Dawnetta L	7/27/2015	F	7	1	41020	2101	F	Reg
KA19131000	Traffic Control Officers Progr	Traffic Control Officer	Butler,Quintina R	7/1/2002	F	9	7	59049	2101	F	Reg
KA19131000	Traffic Control Officers Progr	Traffic Control Officer	Hooks,Beverly A	9/7/2004	F	9	6	57466	2101	F	Reg
KA19131000	Traffic Control Officers Progr	Traffic Control Officer	Craig,Cierra M	3/3/2008	F	9	5	55883	2101	F	Reg
KA19131000	Traffic Control Officers Progr	Traffic Control Officer	Middleton,Comontae C	1/14/2013	F	9	2	51134	2101	F	Reg
KA19131000	Traffic Control Officers Progr	Traffic Control Officer	Roa,Lucia	3/2/2009	F	9	3	52717	2101	F	Reg
KA19131000	Traffic Control Officers Progr	Traffic Control Officer	Bailey,LaCresha N.	1/14/2013	F	9	2	51134	2101	F	Reg
KA19131000	Traffic Control Officers Progr	Traffic Control Officer	Durham,Alvin C	3/3/2008	F	9	5	55883	2101	F	Reg
KA19131000	Traffic Control Officers Progr	Traffic Control Officer	Lewis,John D	2/19/2008	F	9	5	55883	2101	F	Reg
KA19131000	Traffic Control Officers Progr	Traffic Control Officer	Lucas,EDWARD	3/2/2009	F	9	3	52717	2101	F	Reg
KA19131000	Traffic Control Officers Progr	Traffic Control Officer	Green,Carla D	2/4/2008	F	9	5	55883	2101	F	Reg
KA19131000	Traffic Control Officers Progr	Traffic Control Officer	Williams,Roman M.	8/18/2008	F	9	5	55883	2101	F	Reg
KA19131000	Traffic Control Officers Progr	Traffic Control Officer	Davis,Ruqayya R	7/19/2010	F	9	2	51134	2101	F	Reg
KA19131000	Traffic Control Officers Progr	Traffic Control Officer	Hudson,Ikea E.	8/18/2008	F	9	3	52717	2101	F	Reg
KA19131000	Traffic Control Officers Progr	Traffic Control Officer	Brice,George M	8/27/2012	F	9	2	51134	2101	F	Reg
KA19131000	Traffic Control Officers Progr	Traffic Control Officer	Simpson,Lajuan A	10/14/2008	F	9	5	55883	2101	F	Reg
KA19131000	Traffic Control Officers Progr	Traffic Control Officer	Blount Jr.,Milton	6/21/2010	F	9	2	51134	2101	F	Reg
KA19131000	Traffic Control Officers Progr	Traffic Control Officer			V	7	0	41020	2101	F	Reg
KA19131000	Traffic Control Officers Progr	Traffic Control Officer			V	7	1	41020	2101	F	Reg
KA19131000	Traffic Control Officers Progr	Traffic Control Officer			V	9	1	49551	2101	F	Reg

Department ID	Department Name	Job Title	Employee Name	Hire Date	Vacant / Filled Status	Grade	Step	Salary	Series	F/P Time	Reg/Temp/Term
KA19131000	Traffic Control Officers Progr	Traffic Control Officer			V	9	1	49551	2101	F	Reg
KA19132000	School Crossing Control Progra	Lead Safety Technician	Redd,Mattie L	10/12/1999	F	4	8	28678.5	0019	P	Reg
KA19132000	School Crossing Control Progra	Lead Safety Technician	Wright,Faye T	11/9/1998	F	4	7	27891.75	0019	P	Reg
KA19132000	School Crossing Control Progra	Lead Safety Technician	Bailey Wilson,Sheila D	5/16/1989	F	4	10	30252	0019	P	Reg
KA19132000	School Crossing Control Progra	Lead Safety Technician	Williams,Arietta M	9/8/1981	F	4	10	30252	0019	P	Reg
KA19132000	School Crossing Control Progra	Lead Safety Technician	Brown,Marie S	8/22/2005	F	4	8	28678.5	0019	P	Reg
KA19132000	School Crossing Control Progra	Lead Safety Technician	Graham,Shezell	10/25/1999	F	4	6	27105	0019	P	Reg
KA19132000	School Crossing Control Progra	Lead Safety Technician			V	4	1	30895	0019	P	Reg
KA19132000	School Crossing Control Progra	Lead Traffic Control Officer	Steve,Kevin E	8/18/2008	F	11	2	56969	2101	F	Reg
KA19132000	School Crossing Control Progra	Lead Traffic Control Officer	Hunter,James	10/14/2008	F	11	2	56969	2101	F	Reg
KA19132000	School Crossing Control Progra	Lead Traffic Control Officer	Lee,Angela	11/5/2012	F	11	2	56969	2101	F	Reg
KA19132000	School Crossing Control Progra	Safety Tech (Trainee)	Ross,DaVonda	5/19/2014	F	2	5	16176.3	0019	P	Term
KA19132000	School Crossing Control Progra	Safety Tech (Trainee)	Jackson,Daniell	1/13/2014	F	2	3	14460	0019	P	Term
KA19132000	School Crossing Control Progra	Safety Tech (Trainee)	Reed,Holly	11/4/2013	F	2	4	15679.65	0019	P	Term
KA19132000	School Crossing Control Progra	Safety Tech (Trainee)	Sutton,Renice	6/30/2014	F	2	4	15679.65	0019	P	Term
KA19132000	School Crossing Control Progra	Safety Tech (Trainee)	Boggs,Jackie D	11/4/2013	F	2	4	15679.65	0019	P	Term
KA19132000	School Crossing Control Progra	Safety Tech (Trainee)	Gooding,Erickeda	2/10/2014	F	2	3	15183	0019	P	Term
KA19132000	School Crossing Control Progra	Safety Tech (Trainee)	Blowe,Alicia	8/11/2014	F	2	4	15679.65	0019	P	Term
KA19132000	School Crossing Control Progra	Safety Tech (Trainee)	Schools,Alisha	5/5/2014	F	2	4	15679.65	0019	P	Term
KA19132000	School Crossing Control Progra	Safety Tech (Trainee)	Nickens,April L	11/4/2013	F	2	4	15679.65	0019	P	Reg
KA19132000	School Crossing Control Progra	Safety Tech (Trainee)	Dunbar,Symra	5/5/2014	F	2	4	15679.65	0019	P	Term
KA19132000	School Crossing Control Progra	Safety Tech (Trainee)	Greene,Regina	6/30/2014	F	2	4	15679.65	0019	P	Term
KA19132000	School Crossing Control Progra	Safety Tech (Trainee)	Holmes,Sharon	8/26/2013	F	2	3	14460	0019	P	Reg
KA19132000	School Crossing Control Progra	Safety Tech (Trainee)	Nicks,India	5/5/2014	F	2	4	14933	0019	P	Term
KA19132000	School Crossing Control Progra	Safety Tech (Trainee)	Horne,Errol	6/30/2014	F	2	3	14460	0019	P	Term
KA19132000	School Crossing Control Progra	Safety Tech (Trainee)	Chapman,Linda P	6/30/2014	F	2	4	14933	0019	F	Term
KA19132000	School Crossing Control Progra	Safety Tech (Trainee)	Watts,Tachelle	6/30/2014	F	2	3	14460	0019	P	Term
KA19132000	School Crossing Control Progra	Safety Tech (Trainee)	Casey,Jacqueline Y	11/4/2013	F	2	4	14933	0019	P	Reg
KA19132000	School Crossing Control Progra	Safety Tech (Trainee)	Farewell,Monroe	7/14/2014	F	2	4	14933	0019	P	Term
KA19132000	School Crossing Control Progra	Safety Tech (Trainee)	Kashif,Otis A	11/4/2013	F	2	4	14933	0019	P	Reg
KA19132000	School Crossing Control Progra	Safety Tech (Trainee)	Hill,George V	7/14/2014	F	2	4	14933	0019	F	Term
KA19132000	School Crossing Control Progra	Safety Tech (Trainee)	Baucum,Barry	8/12/2013	F	2	4	14933	0019	F	Term
KA19132000	School Crossing Control Progra	Safety Tech (Trainee)	Ambrose,Kendra L	11/4/2013	F	2	4	14933	0019	P	Reg
KA19132000	School Crossing Control Progra	Safety Tech (Trainee)	Miller,Adrienne	8/25/2014	F	2	4	14933	0019	P	Term
KA19132000	School Crossing Control Progra	Safety Tech (Trainee)	Alford,Karyn	8/25/2014	F	2	4	14933	0019	P	Term
KA19132000	School Crossing Control Progra	Safety Tech (Trainee)	O'Neal,Taniesha	8/12/2013	F	2	4	14933	0019	P	Reg
KA19132000	School Crossing Control Progra	Safety Tech (Trainee)			V	2	1	27028	0019	P	Reg
KA19132000	School Crossing Control Progra	Safety Tech (Trainee)			V	2	1	27028	0019	P	Reg
KA19132000	School Crossing Control Progra	Safety Technician	Gibson,Rayne	6/29/2015	F	3	1	15464.4	0019	P	Reg
KA19132000	School Crossing Control Progra	Safety Technician	Warren,Steven	6/29/2015	F	3	1	14728	0019	P	Reg
KA19132000	School Crossing Control Progra	Safety Technician	Muschette,Samantha	3/11/2013	F	3	3	16537.5	0019	P	Reg
KA19132000	School Crossing Control Progra	Safety Technician	Wilder,Daniel N	7/19/2010	F	3	5	16772	0019	P	Reg
KA19132000	School Crossing Control Progra	Safety Technician	Pyles,Sharon D	5/8/2000	F	3	8	19220.25	0019	P	Reg
KA19132000	School Crossing Control Progra	Safety Technician	Brinson,Eula M	8/22/1994	F	3	8	19220.25	0019	P	Reg
KA19132000	School Crossing Control Progra	Safety Technician	Thomas,April C	8/25/2014	F	3	1	15464.4	0019	P	Term
KA19132000	School Crossing Control Progra	Safety Technician	Millard,Antoinette D.	1/3/2012	F	3	5	17610.6	0019	P	Reg
KA19132000	School Crossing Control Progra	Safety Technician	Larry,Sharion R	2/24/2014	F	3	5	17610.6	0019	P	Term
KA19132000	School Crossing Control Progra	Safety Technician	Deal,Candace	9/24/2012	F	3	4	21139.3	0019	P	Term
KA19132000	School Crossing Control Progra	Safety Technician	Miller,Jasmine	9/22/2014	F	3	2	16000.95	0019	P	Reg
KA19132000	School Crossing Control Progra	Safety Technician	Scott,Mary L	8/23/1971	F	3	10	20293.35	0019	P	Reg
KA19132000	School Crossing Control Progra	Safety Technician	Ward,Robbin	5/11/2009	F	3	5	17610.6	0019	P	Reg
KA19132000	School Crossing Control Progra	Safety Technician	Jones,Tara N	4/10/2000	F	3	5	17610.6	0019	P	Reg
KA19132000	School Crossing Control Progra	Safety Technician	Perry,Annie Kathryn	9/17/2007	F	3	7	17794	0019	P	Reg
KA19132000	School Crossing Control Progra	Safety Technician	Dudley,Andria	4/7/2014	F	3	2	16000.95	0019	P	Term
KA19132000	School Crossing Control Progra	Safety Technician	Lindsey,Reacie W	1/17/1989	F	3	9	19756.8	0019	P	Reg
KA19132000	School Crossing Control Progra	Safety Technician	Blount,Jennifer	8/31/2009	F	3	5	17610.6	0019	P	Reg
KA19132000	School Crossing Control Progra	Safety Technician	Crosby,Barbara	8/18/2008	F	3	6	18147.15	0019	P	Reg
KA19132000	School Crossing Control Progra	Safety Technician	Washington,Jordan D	9/22/2014	F	3	2	16000.95	0019	P	Term
KA19132000	School Crossing Control Progra	Safety Technician	Jones,Merial	4/6/2015	F	3	1	15464.4	0019	P	Reg
KA19132000	School Crossing Control Progra	Safety Technician	Anthony,Shirley H	8/20/2007	F	3	6	22467.9	0019	P	Reg
KA19132000	School Crossing Control Progra	Safety Technician	Donley,Shaughn	10/22/2012	F	3	4	16261	0019	P	Reg
KA19132000	School Crossing Control Progra	Safety Technician	Harrod,Gregory A	8/31/2009	F	3	5	17610.6	0019	P	Reg
KA19132000	School Crossing Control Progra	Safety Technician	ROYSTER,EMMA J	9/26/2011	F	3	5	17610.6	0019	P	Reg
KA19132000	School Crossing Control Progra	Safety Technician	Holloman,Latoya K	9/24/2012	F	3	5	17610.6	0019	P	Reg
KA19132000	School Crossing Control Progra	Safety Technician	Dorsey,Sara	6/29/2015	F	3	1	15464.4	0019	P	Reg
KA19132000	School Crossing Control Progra	Safety Technician	Garvin,Thomasine	4/10/2000	F	3	9	19756.8	0019	P	Reg
KA19132000	School Crossing Control Progra	Safety Technician	Butler,Donna M	4/23/2012	F	3	5	21803.6	0019	P	Reg
KA19132000	School Crossing Control Progra	Safety Technician	Coleman,Yolanda Denise	10/14/2008	F	3	7	18683.7	0019	P	Reg
KA19132000	School Crossing Control Progra	Safety Technician	Gray,Edwina R	8/21/2006	F	3	6	18147.15	0019	P	Reg
KA19132000	School Crossing Control Progra	Safety Technician	Gantt,Machelle L	12/19/2011	F	3	5	17610.6	0019	P	Reg
KA19132000	School Crossing Control Progra	Safety Technician	Henson,Dovona S	9/28/1998	F	3	7	18683.7	0019	P	Reg
KA19132000	School Crossing Control Progra	Safety Technician	Brown,Jerome	6/29/2015	F	3	1	15464.4	0019	P	Reg
KA19132000	School Crossing Control Progra	Safety Technician	Atkinson,Anna K	8/20/2007	F	3	7	18683.7	0019	P	Reg
KA19132000	School Crossing Control Progra	Safety Technician	Brinkley,Joann	3/14/1999	F	3	7	18683.7	0019	P	Reg
KA19132000	School Crossing Control Progra	Safety Technician	Pratt,Rhonda D	3/27/2000	F	3	6	18147.15	0019	P	Reg
KA19132000	School Crossing Control Progra	Safety Technician	Thorpe,Eric	3/3/2008	F	3	5	17610.6	0019	P	Reg
KA19132000	School Crossing Control Progra	Safety Technician	Powell,Crystal M	12/7/1998	F	3	7	18683.7	0019	P	Reg
KA19132000	School Crossing Control Progra	Safety Technician	Conner,Towanda A	9/24/2012	F	3	5	17610.6	0019	P	Reg
KA19132000	School Crossing Control Progra	Safety Technician	Williams,Marquett	4/8/2013	F	3	5	17610.6	0019	P	Reg
KA19132000	School Crossing Control Progra	Safety Technician	Hillian,Mary	3/31/2008	F	3	6	18147.15	0019	P	Reg
KA19132000	School Crossing Control Progra	Safety Technician	Hall,Danielle	3/16/2009	F	3	6	17283	0019	P	Reg
KA19132000	School Crossing Control Progra	Safety Technician	Holley,Carol	4/8/2013	F	3	5	17610.6	0019	P	Reg
KA19132000	School Crossing Control Progra	Safety Technician	Gibbs,Kevin	6/29/2015	F	3	1	15464.4	0019	P	Reg
KA19132000	School Crossing Control Progra	Safety Technician	Alvin,Claudia M	1/30/1980	F	3	10	20293.35	0019	P	Reg
KA19132000	School Crossing Control Progra	Safety Technician	Foster,Tamia L	1/3/2012	F	3	5	17610.6	0019	P	Reg
KA19132000	School Crossing Control Progra	Safety Technician	Cook,Kim A	9/8/1992	F	3	7	18683.7	0019	P	Reg
KA19132000	School Crossing Control Progra	Safety Technician	Hargrove,Michelle	1/28/2013	F	3	5	17610.6	0019	P	Reg
KA19132000	School Crossing Control Progra	Safety Technician	Smith,Carolyn R	1/11/1993	F	3	7	18683.7	0019	P	Reg
KA19132000	School Crossing Control Progra	Safety Technician	Blake,Pheisha	9/24/2012	F	3	5	17610.6	0019	P	Reg
KA19132000	School Crossing Control Progra	Safety Technician	Thompson,Jamele Jean	4/8/2013	F	3	5	17610.6	0019	P	Reg
KA19132000	School Crossing Control Progra	Safety Technician	Young,Princeton	7/27/2015	F	3	1	15464.4	0019	P	Reg
KA19132000	School Crossing Control Progra	Safety Technician	Howard,Melissa A	9/28/1998	F	3	7	18683.7	0019	P	Reg
KA19132000	School Crossing Control Progra	Safety Technician	Williams,Monica	10/5/1998	F	3	8	19220.25	0019	P	Reg
KA19132000	School Crossing Control Progra	Safety Technician	Allen,Felicia R	9/8/1992	F	3	9	19756.8	0019	P	Reg

Department ID	Department Name	Job Title	Employee Name	Hire Date	Vacant / Filled Status	Grade	Step	Salary	Series	F/P Time	Reg/Temp/Term
KA19132000	School Crossing Control Progra	Safety Technician	Carter, Tracy D	10/13/1998	F	3	7	18683.7	0019	P	Reg
KA19132000	School Crossing Control Progra	Safety Technician	Mornot, Marie	6/29/2015	F	3	1	15464.4	0019	P	Reg
KA19132000	School Crossing Control Progra	Safety Technician	Robinson, Diane D	8/18/2008	F	3	6	18147.15	0019	P	Reg
KA19132000	School Crossing Control Progra	Safety Technician	Kennedy, Shunell	8/21/2006	F	3	6	18147.15	0019	P	Reg
KA19132000	School Crossing Control Progra	Safety Technician	Pearson, Alberta	9/25/1989	F	3	9	19756.8	0019	P	Reg
KA19132000	School Crossing Control Progra	Safety Technician	White, Sharlene	4/6/2015	F	3	1	15464.4	0019	P	Reg
KA19132000	School Crossing Control Progra	Safety Technician	Jones-Taylor, Darlene G	10/13/1998	F	3	10	20293.35	0019	P	Reg
KA19132000	School Crossing Control Progra	Safety Technician	Hinson, Darlene E	1/19/1988	F	3	9	19756.8	0019	P	Reg
KA19132000	School Crossing Control Progra	Safety Technician	Morrobel, Antonio J	1/11/1993	F	3	8	19220.25	0019	P	Reg
KA19132000	School Crossing Control Progra	Safety Technician	Reynolds, Jacqueline	1/3/2012	F	3	5	17610.6	0019	P	Reg
KA19132000	School Crossing Control Progra	Safety Technician	Morton, Patricia A	1/4/2010	F	3	5	17610.6	0019	P	Reg
KA19132000	School Crossing Control Progra	Safety Technician	Clark, Darlene P	10/13/1998	F	3	9	19756.8	0019	P	Reg
KA19132000	School Crossing Control Progra	Safety Technician	Gibson, Cheryl	11/21/2011	F	3	5	17610.6	0019	P	Reg
KA19132000	School Crossing Control Progra	Safety Technician	Wright Hodo, Pamela M	9/29/2008	F	3	6	17283	0019	P	Reg
KA19132000	School Crossing Control Progra	Safety Technician	Edwards, Robert L	6/21/2010	F	3	5	17610.6	0019	P	Reg
KA19132000	School Crossing Control Progra	Safety Technician	Rogers, Yugenia	5/8/2000	F	3	6	18147.15	0019	P	Reg
KA19132000	School Crossing Control Progra	Safety Technician	Barnes, Leslie	5/8/2006	F	3	6	18147.15	0019	P	Reg
KA19132000	School Crossing Control Progra	Safety Technician	Jones, Shawntice	4/6/2015	F	3	1	15464.4	0019	P	Reg
KA19132000	School Crossing Control Progra	Safety Technician	Robinson, Edward	2/25/2013	F	3	5	16772	0019	P	Reg
KA19132000	School Crossing Control Progra	Safety Technician	Prather-Wilson, Carole D	8/21/2006	F	3	6	18147.15	0019	P	Reg
KA19132000	School Crossing Control Progra	Safety Technician	Smallwood, Cassandra R	8/20/2007	F	3	6	18147.15	0019	P	Reg
KA19132000	School Crossing Control Progra	Safety Technician	West, Gerel	6/29/2015	F	3	1	14728	0019	P	Reg
KA19132000	School Crossing Control Progra	Safety Technician	Harris Jr., Thomas	4/7/2014	F	3	2	16000.95	0019	P	Term
KA19132000	School Crossing Control Progra	Safety Technician	Gray, Bobby	9/10/2012	F	3	5	17610.6	0019	P	Reg
KA19132000	School Crossing Control Progra	Safety Technician	Brown, Dwane A	8/27/2012	F	3	4	17074.05	0019	P	Reg
KA19132000	School Crossing Control Progra	Safety Technician	Morgan, Lolita	8/18/2008	F	3	5	16772	0019	P	Reg
KA19132000	School Crossing Control Progra	Safety Technician	Clark, Delores V	8/22/2005	F	3	7	18683.7	0019	P	Reg
KA19132000	School Crossing Control Progra	Safety Technician	Clark, Cynthia L	8/22/2005	F	3	7	18683.7	0019	P	Reg
KA19132000	School Crossing Control Progra	Safety Technician	Davis, Tameka	8/20/2007	F	3	6	18147.15	0019	P	Reg
KA19132000	School Crossing Control Progra	Safety Technician	Williams, Charlene	11/5/2012	F	3	5	17610.6	0019	P	Reg
KA19132000	School Crossing Control Progra	Safety Technician	Middleton, Latarsha	8/22/2005	F	3	6	18147.15	0019	P	Reg
KA19132000	School Crossing Control Progra	Safety Technician	Brown, Joyce	4/18/2006	F	3	7	18683.7	0019	P	Reg
KA19132000	School Crossing Control Progra	Safety Technician	Rhodes, Raynetta P	8/22/2005	F	3	7	18683.7	0019	P	Reg
KA19132000	School Crossing Control Progra	Safety Technician	Mills, Chiquita D	8/22/2005	F	3	6	18147.15	0019	P	Reg
KA19132000	School Crossing Control Progra	Safety Technician	Gibbons, Rochelle	10/14/2008	F	3	6	17283	0019	P	Reg
KA19132000	School Crossing Control Progra	Safety Technician	Ware, Kimberly	10/22/2012	F	3	5	16772	0019	P	Term
KA19132000	School Crossing Control Progra	Safety Technician	Brennon, Nicole	12/31/2012	F	3	5	16772	0019	P	Reg
KA19132000	School Crossing Control Progra	Safety Technician	Womble, Earl L	4/23/2012	F	3	5	16772	0019	P	Reg
KA19132000	School Crossing Control Progra	Safety Technician	Lucas, Annette	9/15/2008	F	3	6	17283	0019	P	Reg
KA19132000	School Crossing Control Progra	Safety Technician	Mayo, Marsha Beatrice	10/14/2008	F	3	6	17283	0019	P	Reg
KA19132000	School Crossing Control Progra	Safety Technician	Brown, Jacqueline Y	8/2/2010	F	3	5	16772	0019	P	Reg
KA19132000	School Crossing Control Progra	Safety Technician	Carter, Sylvia	3/11/2013	F	3	5	16772	0019	F	Reg
KA19132000	School Crossing Control Progra	Safety Technician	Smith, Ella L	9/26/2011	F	3	5	16772	0019	F	Reg
KA19132000	School Crossing Control Progra	Safety Technician	Taylor-Womack, Deborah	3/29/2010	F	3	5	16772	0019	P	Reg
KA19132000	School Crossing Control Progra	Safety Technician	Mitchell, Kenneth E	8/27/2012	F	3	4	16261	0019	P	Reg
KA19132000	School Crossing Control Progra	Safety Technician	Walker, Debra	4/21/2014	F	3	2	16000.95	0019	P	Term
KA19132000	School Crossing Control Progra	Safety Technician	Brown, Gracie	10/14/2008	F	3	6	17283	0019	F	Reg
KA19132000	School Crossing Control Progra	Safety Technician	Davis, Louise	4/26/2010	F	3	5	16772	0019	P	Reg
KA19132000	School Crossing Control Progra	Safety Technician	ALLEN, BERNITA L	6/3/2013	F	3	5	16772	0019	F	Reg
KA19132000	School Crossing Control Progra	Safety Technician	HUMES, DEIDRE	1/3/2012	F	3	5	16772	0019	P	Reg
KA19132000	School Crossing Control Progra	Safety Technician	Brown Jr., Moses Clyde	10/14/2008	F	3	6	17283	0019	F	Reg
KA19132000	School Crossing Control Progra	Safety Technician	Smith, Rockelle R	10/14/2008	F	3	6	17283	0019	P	Reg
KA19132000	School Crossing Control Progra	Safety Technician	Tymus, Rosalind D.	10/14/2008	F	3	5	16283.5	0019	F	Term
KA19132000	School Crossing Control Progra	Safety Technician	Greely, Brendella M	8/31/2009	F	3	5	16772	0019	P	Reg
KA19132000	School Crossing Control Progra	Safety Technician	Tate, Thomas R	10/14/2008	F	3	10	19327	0019	F	Reg
KA19132000	School Crossing Control Progra	Safety Technician	Paige, Tina V	10/14/2008	F	3	6	17283	0019	F	Reg
KA19132000	School Crossing Control Progra	Safety Technician	Burnett, Phyllis Sheryllyn	9/10/2012	F	3	4	16261	0019	F	Reg
KA19132000	School Crossing Control Progra	Safety Technician	David, Patricia A	9/14/2009	F	3	6	17283	0019	P	Reg
KA19132000	School Crossing Control Progra	Safety Technician	Griffin, Billy	3/11/2013	F	3	5	16772	0019	P	Reg
KA19132000	School Crossing Control Progra	Safety Technician	Wilson, Michelle		F	3	6	17283	0019	P	Reg
KA19132000	School Crossing Control Progra	Safety Technician	Jackson, Felicia Danielle	10/14/2008	F	3	6	17283	0019	P	Reg
KA19132000	School Crossing Control Progra	Safety Technician	Thomas, Kareema Jeanette	5/21/2012	F	3	4	16261	0019	P	Reg
KA19132000	School Crossing Control Progra	Safety Technician	Horton, Shanika	1/30/2012	F	3	5	16772	0019	P	Reg
KA19132000	School Crossing Control Progra	Safety Technician	Williams, Deborah	5/11/2009	F	3	5	16772	0019	P	Reg
KA19132000	School Crossing Control Progra	Safety Technician	Alston, Lince	9/10/2012	F	3	4	16261	0019	P	Reg
KA19132000	School Crossing Control Progra	Safety Technician	Copeland, Dominique J	3/15/2010	F	3	5	16772	0019	P	Reg
KA19132000	School Crossing Control Progra	Safety Technician	Hines, Shirmeka B	8/10/2015	F	3	1	14728	0019	P	Reg
KA19132000	School Crossing Control Progra	Safety Technician	Worthy, Angela	12/3/2012	F	3	5	16772	0019	P	Reg
KA19132000	School Crossing Control Progra	Safety Technician	Offutt, Theresa Marie	10/14/2008	F	3	6	17283	0019	P	Reg
KA19132000	School Crossing Control Progra	Safety Technician	Powell, Joseph	5/21/2012	F	3	6	17283	0019	P	Reg
KA19132000	School Crossing Control Progra	Safety Technician	McPhatter, Alice M	3/15/2010	F	3	5	16772	0019	P	Reg
KA19132000	School Crossing Control Progra	Safety Technician	Thomas, Alisha	4/27/2009	F	3	5	16772	0019	P	Reg
KA19132000	School Crossing Control Progra	Safety Technician	Ashton, Kayola	6/17/2013	F	3	5	16772	0019	P	Reg
KA19132000	School Crossing Control Progra	Safety Technician	Parks, Martina	5/5/2014	F	3	2	15239	0019	P	Term
KA19132000	School Crossing Control Progra	Safety Technician	Hall, Edward S	8/16/2010	F	3	5	16772	0019	P	Reg
KA19132000	School Crossing Control Progra	Safety Technician	Ford Sr., Michael P	8/30/2010	F	3	5	16772	0019	P	Reg
KA19132000	School Crossing Control Progra	Safety Technician	Gatling, Maurice	12/22/2008	F	3	6	17283	0019	P	Reg
KA19132000	School Crossing Control Progra	Safety Technician	Sharpe, Tan Eka	12/22/2008	F	3	6	17283	0019	P	Reg
KA19132000	School Crossing Control Progra	Safety Technician	Harvey, Stacy	1/30/2012	F	3	5	16772	0019	P	Reg
KA19132000	School Crossing Control Progra	Safety Technician	Lewis, Tonya C	10/24/2011	F	3	5	16772	0019	P	Reg
KA19132000	School Crossing Control Progra	Safety Technician	Joshua, Corderro D	2/1/2010	F	3	6	17283	0019	P	Reg
KA19132000	School Crossing Control Progra	Safety Technician	Butler, Helen	12/3/2012	F	3	5	16772	0019	P	Reg
KA19132000	School Crossing Control Progra	Safety Technician	Watson, Lonnie R	2/1/2010	F	3	5	16772	0019	P	Reg
KA19132000	School Crossing Control Progra	Safety Technician	Humphrey, Otis E	11/4/2013	F	3	3	15750	0019	P	Reg
KA19132000	School Crossing Control Progra	Safety Technician	Butler, Tynia P	5/7/2012	F	3	5	16772	0019	P	Reg
KA19132000	School Crossing Control Progra	Safety Technician			V	3	1	29456	0019	P	Reg
KA19132000	School Crossing Control Progra	Safety Technician			V	3	1	29456	0019	P	Reg
KA19132000	School Crossing Control Progra	Safety Technician			V	3	1	29456	0019	P	Reg
KA19132000	School Crossing Control Progra	Safety Technician			V	3	1	29456	0019	P	Reg
KA19132000	School Crossing Control Progra	Safety Technician			V	3	1	29456	0019	P	Reg
KA19132000	School Crossing Control Progra	Safety Technician			V	3	1	29456	0019	P	Reg
KA19132000	School Crossing Control Progra	Safety Technician			V	3	1	29456	0019	P	Reg
KA19132000	School Crossing Control Progra	Safety Technician			V	3	1	29456	0019	P	Reg
KA19132000	School Crossing Control Progra	Safety Technician			V	3	1	29456	0019	P	Reg
KA19132000	School Crossing Control Progra	Safety Technician			V	3	1	29456	0019	P	Reg
KA19132000	School Crossing Control Progra	Safety Technician			V	3	1	29456	0019	P	Reg
KA19132000	School Crossing Control Progra	Safety Technician			V	3	1	29456	0019	P	Reg

Department ID	Department Name	Job Title	Employee Name	Hire Date	Vacant / Filled Status	Grade	Step	Salary	Series	F/P Time	Reg/Temp/Term
KA1930000	Traffic Services Field Operati	SUPV ENGINEERING TECH	Waalidijk,David S	1/18/2000	F	12	0	80477.15	0802	F	Reg
KA19311000	Sign Installation Team (Teams	Laborer			V	4	1	36483.2	3502	F	Reg
KA19311000	Sign Installation Team (Teams	Street Sign Installer (MVO)	Barnes,Leon C	11/13/2007	F	8	7	56014.4	4701	F	Reg
KA19311000	Sign Installation Team (Teams	Street Sign Installer (MVO)	Payton,Robert L	1/22/2007	F	8	10	60819.2	4701	F	Reg
KA19311000	Sign Installation Team (Teams	Street Sign Installer (MVO)	Lewis,Yazid	11/13/2007	F	8	7	56014.4	4701	F	Reg
KA19311000	Sign Installation Team (Teams	Street Sign Installer (MVO)	Cole,Carlos Damond	12/10/2007	F	8	6	54412.8	4701	F	Reg
KA19311000	Sign Installation Team (Teams	STREET SIGN INSTALLER MVO	Street,Jason	3/25/2002	F	9	9	62296	4701	F	Reg
KA19311000	Sign Installation Team (Teams	STREET SIGN INSTALLER MVO	Claggett,Eric A	8/27/2001	F	9	10	64001.6	4701	F	Reg
KA19311000	Sign Installation Team (Teams	STREET SIGN INSTALLER MVO	Wilson,William E	5/31/2005	F	9	7	58884.8	4701	F	Reg
KA19311000	Sign Installation Team (Teams	STREET SIGN INSTALLER MVO	Richardson,Maurice	3/6/1997	F	9	9	62296	4701	F	Reg
KA19311000	Sign Installation Team (Teams	STREET SIGN INSTALLER MVO	Jakes,Phyllis	7/8/1985	F	9	10	64001.6	4701	F	Reg
KA19311000	Sign Installation Team (Teams	STREET SIGN INSTALLER MVO	James,Dion L	8/27/2001	F	9	10	64001.6	4701	F	Reg
KA19311000	Sign Installation Team (Teams	STREET SIGN INSTALLER MVO	Gaston,Lavalle E	9/10/2001	F	9	10	64001.6	4701	F	Reg
KA19311000	Sign Installation Team (Teams	STREET SIGN INSTALLER MVO	Berry,James S	2/29/1988	F	9	10	64001.6	4701	F	Reg
KA19311000	Sign Installation Team (Teams	STREET SIGN INSTALLER MVO	Miller Jr.,Edward	9/10/1998	F	9	10	64001.6	4701	F	Reg
KA19311000	Sign Installation Team (Teams	STREET SIGN INSTALLER MVO	Philson,Maurice D	5/15/2006	F	9	7	58884.8	4701	F	Reg
KA19311000	Sign Installation Team (Teams	STREET SIGN INSTALLER MVO			V	8	1	46404.8	4701	F	Reg
KA19312000	Pavement Marking Crew	Pavement Marking Equip Oper	Wilks,Todd Sylvester	5/6/2002	F	10	10	67267.2	5701	F	Reg
KA19312000	Pavement Marking Crew	Pavement Marking Equip Oper	Hart,Rodney L	3/25/2002	F	10	8	63689.6	5701	F	Reg
KA19312200	Layout Crew	ENGINEERING EQUIPMENT OPR			V	10	1	51168	5716	F	Reg
KA19312200	Layout Crew	Pavement Marking Equip Oper	Hart,Rodney L	3/25/2002	F	10	9	65478.4	5701	F	Reg
KA19322000	Traffic Signal Maintenance Sec	Engineering Tech. (Electrical)	Mccoy,Reginald Q	8/3/1987	F	12	6	85332	0802	F	Reg
KA19322000	Traffic Signal Maintenance Sec	Engineering Tech. (Electrical)	Roa,Luis Ernesto	9/4/2007	F	12	6	85332	0802	F	Reg
KA19322000	Traffic Signal Maintenance Sec	Engineering Tech. (Electrical)	Mcintosh,Michael T	3/7/1983	F	12	6	85332	0802	F	Reg
KA19322000	Traffic Signal Maintenance Sec	Engineering Tech. (Electrical)	Moore,Joseph W	6/4/2001	F	11	10	76969	0802	F	Reg
KA19322000	Traffic Signal Maintenance Sec	Engineering Tech. (Electrical)			V	12	1	73867	0802	F	Reg
KA19322000	Traffic Signal Maintenance Sec	Program Analyst	Greenaway,LaTasha K	11/23/2009	F	11	2	56969	0343	F	Reg
KA19322000	Traffic Signal Maintenance Sec	STREET SIGN INSTALLER MVO	Thompson,Virgil	8/27/2001	F	9	10	64001.6	4701	F	Reg
KA19330000	Streetlight Maintenance Sectio	Traffic Systems Maintenance Ma			V	15	0	128879	2101	F	Reg
KA19400000	Bridge & Street Maintenance	CONSTRUCTION REP MAINTENANCE	Lucas,Chall A	6/25/2007	F	8	6	52222	0809	F	Reg
KA19400000	Bridge & Street Maintenance	CONSTRUCTION REPRESENTATIVE	Nobles,Derrick J	12/31/2001	F	11	8	73131	0809	F	Reg
KA19400000	Bridge & Street Maintenance	ENGINEERING EQUIPMENT OPR	Smith,Kenneth W	2/6/1984	F	11	9	68785.6	5716	F	Reg
KA19400000	Bridge & Street Maintenance	Engineering Technician (Civil)	McKinney,Ricardo	4/24/2000	F	7	7	49570	0802	F	Reg
KA19400000	Bridge & Street Maintenance	Equip Oper Supvr (Heavy Equip)	Lott,Joanell S	7/10/2006	F	11	0	62001	4701	F	Reg
KA19400000	Bridge & Street Maintenance	Management Analyst	Tenbrook,Charles H	2/19/2008	F	12	2	70414	0343	F	Reg
KA19400000	Bridge & Street Maintenance	Management Analyst	Ajagba,Laurita	4/6/2015	F	12	4	74654	0343	F	Reg
KA19400000	Bridge & Street Maintenance	MOTOR VEHICLE OPERATOR	Sykes,Clarence R	4/19/2004	F	8	8	57616	5703	F	Reg
KA19400000	Bridge & Street Maintenance	MOTOR VEHICLE OPERATOR	Burnette,Antonio U	5/16/2005	F	8	8	57616	5703	F	Reg
KA19400000	Bridge & Street Maintenance	MOTOR VEHICLE OPERATOR	Miller,Lorenzo Oliver	10/25/2010	F	8	8	57616	5703	F	Reg
KA19400000	Bridge & Street Maintenance	Program Analyst			V	13	1	78687	343	F	Reg
KA19400000	Bridge & Street Maintenance	Program Support Assistant (OA)	Marshall,Celicia L	1/12/2009	F	7	5	43195	0303	F	Reg
KA19400000	Bridge & Street Maintenance	Street & Bridge Maint Prog Mgr	Arno,Reginald	7/12/2004	F	15	0	116792.7	9888	F	Reg
KA19400000	Bridge & Street Maintenance	Supervisory Engineering Techni	Strange,James E	11/13/2006	F	13	0	113233.8	0802	F	Reg
KA19400000	Bridge & Street Maintenance	SUPV ENGINEERING TECH	Salmon,Willie M	10/7/2002	F	12	0	80477.15	0802	F	Reg
KA19400000	Bridge & Street Maintenance	SUPVY MAINTENANCE & OP PLANNR			V	14	1	116107	301	F	Reg
KA19410000	Roadway Maintenance Section	BRIDGE REPAIRER	Jackson,Gary J	1/22/2007	F	10	4	56534.4	5301	F	Reg
KA19410000	Roadway Maintenance Section	ENGINEERING EQUIPMENT OPERATOR	Callahan,Robert	8/9/2006	F	8	8	57616	5716	F	Reg
KA19410000	Roadway Maintenance Section	MOTOR VEHICLE OPERATOR	Beckham,Tyrell	1/11/2016	F	7	0	46404.8	5703	F	Reg
KA19410000	Roadway Maintenance Section	Roadway Maintenance Supervisor	Wooten,George Anthony	10/26/1987	F	7	10	63169.6	3601	F	Reg
KA19410000	Roadway Maintenance Section	Roadway Maintenance Supervisor	Patterson,Jerman E	8/11/2014	F	7	9	61484.8	3601	F	Reg
KA19410000	Roadway Maintenance Section	ROADWAY MAINTENANCE SUPV			V	13	0	100962.5	3601	F	Reg
KA19411000	Ward 1 & 2	ASPHALT WORKER	Gaines,John F	4/23/2001	F	7	8	54558.4	3653	F	Reg
KA19411000	Ward 1 & 2	ASPHALT WORKER LEADER	Williams,Jeffrey W	3/25/2002	F	7	8	59675.2	3653	F	Reg
KA19411000	Ward 1 & 2	Laborer	Dawkins,Stanley M	9/21/2015	F	4	1	36483.2	3502	F	Reg
KA19412000	Ward 3 & 4	ASPHALT WORKER	Taqee,Hasan Najm	10/1/2007	F	7	5	50003.2	3653	F	Reg
KA19412000	Ward 3 & 4	ASPHALT WORKER	Garnett,Earl	3/25/2002	F	7	8	54558.4	3653	F	Reg
KA19412000	Ward 3 & 4	ASPHALT WORKER	Miller,Ronald R	11/26/2007	F	7	6	51521.6	3653	F	Reg
KA19412000	Ward 3 & 4	ASPHALT WORKER	Young,Douglas	1/6/2001	F	7	8	54558.4	3653	F	Reg
KA19412000	Ward 3 & 4	ASPHALT WORKER	Johnson,Clifton	12/13/2008	F	7	4	48484.8	3653	F	Reg
KA19412000	Ward 3 & 4	ASPHALT WORKER LEADER	Lake,Osborne	3/16/2009	F	7	5	54683.2	3653	F	Reg
KA19412000	Ward 3 & 4	MOTOR VEHICLE OPERATOR	Parker,Joseph J	10/16/2006	F	8	7	56014.4	5703	F	Reg
KA19413000	Ward 5 & 6	ASPHALT WORKER	Tinner,Paulette E	3/25/2002	F	7	8	54558.4	3653	F	Reg
KA19413000	Ward 5 & 6	ASPHALT WORKER LEADER	Weems,Anitra T	4/23/2001	F	7	8	59675.2	3653	F	Reg
KA19413000	Ward 5 & 6	ENGINEERING EQUIPMENT OPR	Butler,Marques Vincent	3/20/2006	F	11	10	70678.4	5716	F	Reg
KA19413000	Ward 5 & 6	Laborer	Robinson,Justin	4/8/2013	F	4	3	38979.2	3502	F	Reg
KA19413000	Ward 5 & 6	MOTOR VEHICLE OPERATOR	Gamble,Terrence T	11/14/2005	F	8	7	56014.4	5703	F	Reg
KA19413000	Ward 5 & 6	MOTOR VEHICLE OPERATOR	Brown,Derrick E	8/2/2010	F	8	4	51209.6	5703	F	Reg
KA19413000	Ward 5 & 6	Motor Vehicle Operator			V	7	1	43929.6	5703	F	Reg
KA19413000	Ward 5 & 6	Roadway Maintenance Supervisor	Whren,James A	2/2/2009	F	7	9	61484.8	3601	F	Reg
KA19414000	Ward 7 & 8	ASPHALT WORKER	Jones,Derrick A	3/25/2002	F	7	8	54558.4	3653	F	Reg
KA19414000	Ward 7 & 8	ASPHALT WORKER	Johnson,Brenda M	1/2/2001	F	7	8	54558.4	3653	F	Reg
KA19414000	Ward 7 & 8	ASPHALT WORKER	MIMS,MICHAEL R	12/10/2007	F	7	4	48484.8	3653	F	Reg
KA19414000	Ward 7 & 8	ASPHALT WORKER FOREMAN	Owens,Anthony	1/2/2001	F	6	8	57075.2	3653	F	Reg
KA19414000	Ward 7 & 8	ASPHALT WORKER LEADER	Jackson,Michael A	10/3/2005	F	7	9	61339.2	3653	F	Reg
KA19414000	Ward 7 & 8	ASPHALT WORKER LEADER	Short,Ricardo O	1/2/2001	F	7	9	61339.2	3653	F	Reg
KA19421000	Speed Hump Unit	ASPHALT WORKER	Ellerbe,Keith R	7/10/1987	F	3	10	44512	3653	F	Reg
KA19421000	Speed Hump Unit	ASPHALT WORKER	Silva,Jose C	8/16/2010	F	7	4	48484.8	3653	F	Reg
KA19421000	Speed Hump Unit	ASPHALT WORKER	Hoes,Lawrence E	4/1/2002	F	5	8	48235.2	3653	F	Reg
KA19421000	Speed Hump Unit	ASPHALT WORKER LEADER	Rosebar, Richard T	3/25/2002	F	7	8	59675.2	3653	F	Reg
KA19421000	Speed Hump Unit	ENGINEERING EQUIPMENT OPR	Ellis,Daniel	2/7/2005	F	11	9	68785.6	5716	F	Reg
KA19421000	Speed Hump Unit	Roadway Maintenance Supervisor			V	7	1	48006.4	5716	F	Reg
KA19421000	Speed Hump Unit	Roadway Maintenance Supervisor			V	7	1	48006.4	5716	F	Reg
KA19422000	Milling/Spray Patch Unit	ASPHALT WORKER	Gross,Myron	4/1/2002	F	7	7	53040	3653	F	Reg
KA19422000	Milling/Spray Patch Unit	ASPHALT WORKER	Gaines,Armell	8/15/2006	F	7	7	53040	3653	F	Reg
KA19422000	Milling/Spray Patch Unit	ASPHALT WORKER LEADER	Miller,Anthony D	1/26/2004	F	7	7	58011.2	3653	F	Reg
KA19422000	Milling/Spray Patch Unit	Engineer. Equipment Operator	Lancaster,Clifford G	1/2/2004	F	11	9	68785.6	5716	F	Reg
KA19422000	Milling/Spray Patch Unit	MOTOR VEHICLE OPERATOR	Johnson,Donald E	4/18/2006	F	8	7	56014.4	5703	F	Reg
KA19422000	Milling/Spray Patch Unit	MOTOR VEHICLE OPERATOR	Wheeler,Benjamin	4/18/2006	F	8	7	56014.4	5703	F	Reg
KA19423000	Paving Unit	ASPHALT WORKER	Brown,Michael Lee	12/9/2007	F	7	4	48484.8	3653	F	Reg
KA19423000	Paving Unit	Engineer. Equipment Operator	Thompson Jr.,Lucuis	12/24/2007	F	11	8	66892.8	5716	F	Reg
KA19423000	Paving Unit	Engineer. Equipment Operator	Short,Rashaad Dante	11/13/2007	F	11	4	59321.6	5716	F	Reg
KA19423000	Paving Unit	MOTOR VEHICLE OPERATOR	Clayton,James	6/13/2005	F	8	8	57616	5703	F	Reg
KA19423000	Paving Unit	MOTOR VEHICLE OPERATOR	Holman,Terri B	10/17/2005	F	8	7	56014.4	5703	F	Reg
KA19423000	Paving Unit	MOTOR VEHICLE OPERATOR	Jackson,Garrett	4/18/2006	F	8	7	56014.4	5703	F	Reg
KA19424000	Bridge Operations Unit	BRIDGE REPAIRER	Simpson,Tensly	9/17/2007	F	8	5	52811.2	5301	F	Reg

Department ID	Department Name	Job Title	Employee Name	Hire Date	Vacant / Filled Status	Grade	Step	Salary	Series	F/P Time	Reg/Temp/Term
KA19424000	Bridge Operations Unit	BRIDGE REPAIRER	Wheeler,Keonne	9/6/2005	F	10	5	58323.2	5301	F	Reg
KA19424000	Bridge Operations Unit	BRIDGE REPAIRER	Phillips,Cornelius E	9/6/2005	F	10	5	58323.2	5301	F	Reg
KA19424000	Bridge Operations Unit	BRIDGE REPAIRER	Taylor,Robert	1/4/1988	F	10	10	67267.2	5301	F	Reg
KA19424000	Bridge Operations Unit	BRIDGE REPAIRER	Wilson,Michael E	9/17/2007	F	8	5	52811.2	5301	F	Reg
KA19424000	Bridge Operations Unit	BRIDGE REPAIRER	Dawkins,Michael	10/17/2005	F	8	5	52811.2	5301	F	Reg
KA19424000	Bridge Operations Unit	BRIDGE REPAIRER	Taylor Jr.,Julius	10/2/2006	F	8	5	52811.2	5301	F	Reg
KA19424000	Bridge Operations Unit	BRIDGE REPAIRER	Florance,Jonas J	2/5/2007	F	10	10	67267.2	5301	F	Reg
KA19424000	Bridge Operations Unit	DRAWBRIDGE OPERATOR			V	9	1	48651.2	5430	F	Reg
KA19424000	Bridge Operations Unit	DRAWBRIDGE OPERATOR			V	9	1	48651.2	5430	F	Reg
KA19424000	Bridge Operations Unit	Engineering Technician	Mcneely,Robert L	2/7/1972	F	12	8	89918	0802	F	Reg
KA19425000	Crack Seal Unit	ASPHALT WORKER	Grimes,Robert D	3/25/2002	F	7	7	53040	3653	F	Reg
KA19425000	Crack Seal Unit	ASPHALT WORKER	Willis,Barbara J	8/26/2002	F	7	8	54558.4	3653	F	Reg
KA19425000	Crack Seal Unit	Laborer	Wilkinson,Darrell R	6/23/2008	F	4	2	37731.2	3502	F	Reg
KA19425000	Crack Seal Unit	MOTOR VEHICLE OPERATOR	Chappelle,Barrington E	12/8/2003	F	8	9	59217.6	5703	F	Reg
KA19425000	Crack Seal Unit	MOTOR VEHICLE OPERATOR	Love,Eugene	10/1/2007	F	8	6	54412.8	5703	F	Reg
KA19425000	Crack Seal Unit	MOTOR VEHICLE OPERATOR			V	8	1	46404.8	5703	F	Reg
KA19425000	Crack Seal Unit	Street Sign Installer	Leary,Santini	4/7/2014	F	7	1	43929.6	4701	F	Reg
KA19426000	Maintainer Unit	ASPHALT WORKER	Modenessi I,Victor M	10/12/2010	F	5	5	44241.6	3653	F	Reg
KA19426000	Maintainer Unit	Engineer, Equipment Operator	Nelson,Michael J	12/10/2007	F	11	5	61214.4	5716	F	Reg
KA19426000	Maintainer Unit	MOTOR VEHICLE OPERATOR	Treadwell,Johnnie M	3/5/2007	F	8	8	57616	5703	F	Reg
KA19427000	Sidewalk/Concrete Brick Mainte	ENGINEERING EQUIPMENT OPR	Bell,Anthony	6/20/1985	F	11	9	68785.6	5716	F	Reg
KA19427000	Sidewalk/Concrete Brick Mainte	Laborer	Sims,Dean	12/17/2012	F	4	4	40227.2	3502	F	Reg
KA19427000	Sidewalk/Concrete Brick Mainte	MASONRY WORKER	Coates,Mathew H	3/25/2013	F	8	5	52811.2	3603	F	Reg
KA19427000	Sidewalk/Concrete Brick Mainte	MASONRY WORKER	Canning,Sean A	8/25/2014	F	8	9	59217.6	3603	F	Reg
KA19427000	Sidewalk/Concrete Brick Mainte	MOTOR VEHICLE OPERATOR	Jones,Steven W	11/7/2011	F	8	8	57616	5703	F	Reg
KA19428000	Alley Paving Unit	ASPHALT WORKER FOREMAN	Morris,Robert H d	8/11/1986	F	6	10	60236.8	3653	F	Reg
KA19428000	Alley Paving Unit	ASPHALT WORKER LEADER	Williams,Andrea B	1/31/2000	F	7	9	61339.2	3653	F	Reg
KA19428000	Alley Paving Unit	ENGINEERING EQUIPMENT OPR	Bell Jr.,Thomas Harold	12/9/1968	F	11	10	70678.4	5716	F	Reg
KA19428000	Alley Paving Unit	ENGINEERING EQUIPMENT OPR			V	11	1	53643.2	5716	F	Reg
KA19428000	Alley Paving Unit	Masonry Leader	Jones,Roland D	3/27/1990	F	8	6	59758.4	3603	F	Reg
KA19428000	Alley Paving Unit	Masonry Worker	Shorter,Gregory R	10/6/2014	F	8	8	57616	3603	F	Reg
KA19428000	Alley Paving Unit	MOTOR VEHICLE OPERATOR	MATHIS,REGINALD BRYAN	11/19/2012	F	8	5	52811.2	5703	F	Term
KA19428000	Alley Paving Unit	MOTOR VEHICLE OPERATOR	Miller,George J	6/6/2011	F	8	5	52811.2	5703	F	Reg
KA19428000	Alley Paving Unit	Roadway Maintenance Supervisor	Ross,Tritty K	4/1/2002	F	7	10	63169.6	3601	F	Reg
KA19430000	Heavy Equipment Operations Sec	MOTOR VEHICLE OPERATOR	Hazel,Robert D.	5/10/2010	F	8	5	52811.2	5703	F	Reg
KA19431000	Equipment Maintenance Unit	Pavement Marking Equip Oper	King,Charles	10/17/2005	F	10	8	63689.6	5701	F	Reg
KA19431000	Equipment Maintenance Unit	ROADWAY MAINTENANCE SUPV	Baxter,Donald	11/24/2008	F	13	0	117789.4	0301	F	Reg
KA19431000	Equipment Maintenance Unit	Traffic Systems Maintenance Ma	Walker,Robert D	3/25/2002	F	14	0	96756	2101	F	Reg
KA19432000	Fleet Management	STAFF ASST	Davis,Vicki	11/11/1988	F	11	7	65839	0301	F	Reg
KA19500000	System Inspection & Oversight	CONSTRUCTION REPRESENTATIVE			V	9	1	49551	0809	F	Reg
KA19500000	System Inspection & Oversight	Program Support Assistant	Henderson,Antania	2/17/2001	F	8	8	55092	0303	F	Reg
KA19600000	Transportation Services Team (Construction Control Rep (Main	Nwabueze,Victor P	12/4/2001	F	11	8	73131	0809	F	Reg
KA19600000	Transportation Services Team (Electrical Engineer	Safarian,Kajaz	6/19/2000	F	13	8	104207	0850	F	Reg
KA19600000	Transportation Services Team (Management Analyst	Sartin,Lanel	8/23/2004	F	12	2	70414	0343	F	Reg
KA19610000	Traffic Calming Wards 1, 2, 3	Construction Control Rep (Main	Hassan,Mohamud A	6/19/1989	F	11	8	73131	0809	F	Reg
KA19610000	Traffic Calming Wards 1, 2, 3	Construction Control Rep (Main	Misher,Darlene	4/15/1996	F	11	6	69293	0809	F	Reg
KA19610000	Traffic Calming Wards 1, 2, 3	Engineering Tech. (Civil)	Lowery,Andrea T	11/5/1990	F	11	8	73131	0802	F	Reg
KA19610000	Traffic Calming Wards 1, 2, 3	Engineering Technician	Mason,Kenneth B	8/29/1988	F	12	7	87625	0802	F	Reg
KA19610000	Traffic Calming Wards 1, 2, 3	Supervisory Engineering Tech.	Coles,Tracy	11/24/1981	F	13	0	97143.43	0802	F	Reg
KA19610000	Traffic Calming Wards 1, 2, 3	Transportation Engineering Tec	Carter,Vincent E	1/13/2003	F	12	6	85332	0802	F	Reg
KA19620000	Traffic Calming City-Wide	Construction Control Rep (Main	Nickens Watson,Angela T	6/25/1984	F	11	10	76969	0809	F	Reg
KA19620000	Traffic Calming City-Wide	Engineering Tech. (Civil)	Hill Jr.,Obrien	8/13/1990	F	11	9	75050	0802	F	Reg
KA19620000	Traffic Calming City-Wide	Engineering Tech. (Civil)	Smith,Darrell E	5/14/1984	F	11	10	76969	0802	F	Reg
KA19620000	Traffic Calming City-Wide	Engineering Tech. (Civil)	Smith,Robert E	12/31/1986	F	10	5	61331	0802	F	Reg
KA19620000	Traffic Calming City-Wide	Engineering Tech. (Civil)	Briscoe,Sonya L	6/8/1988	F	11	8	73131	0802	F	Reg
KA19620000	Traffic Calming City-Wide	Parking Operations Specialist	Banks,Sherr E	4/17/1987	F	11	6	69293	0301	F	Reg
KA19620000	Traffic Calming City-Wide	Supervisory Engineering Tech.	Bhatia,Sandeep Singh	9/24/2012	F	12	0	93428.16	0802	F	Reg
KA19630000	Traffic Calming Wards 5, 6, 7	Engineering Tech. (Civil)			V	11	1	59698	0802	F	Reg
KA19630000	Traffic Calming Wards 5, 6, 7	Engineering Technician	Ullah,Mohammad O	6/1/1992	F	12	7	87625	0802	F	Reg
KA19630000	Traffic Calming Wards 5, 6, 7	Supvy Civil Engineering Tech	Wheeler,Constance G	8/29/2000	F	13	0	90906.14	0802	F	Reg
KA19630000	Traffic Calming Wards 5, 6, 7	Transportation Spec (Traff Op)			V	12	1	73867		F	Reg
UFA											
KA10100000	UFA	Assoc Dir., Urban Forestry Adm			V	15	0	128879	0301	F	Reg
KA10100000	UFA	Cust Svc Communications Spec			V	9	1	45811	0301	F	Reg
KA10100000	UFA	CUSTOMER SERVICE COMM SPEC			V	9	1	45811	0301	F	Reg
KA10100000	UFA	Dep Assoc Dir for Urb Forestry	Eutsler,Earl C	3/22/2004	F	14	0	116511.1	0460	F	Reg
KA10100000	UFA	Forester (Urban)	Yturralde,Kasey Maria	12/16/2013	F	11	8	67613	0460	F	Reg
KA10100000	UFA	Forester (Urban)	O'Neill,John	8/12/2013	F	11	3	58743	0460	F	Reg
KA10100000	UFA	Forester (Urban)	Just,Daniel	2/23/2015	F	9	3	48739	9888	F	Reg
KA10100000	UFA	STAFF ASSISTANT	Duncan,Lennita M	8/20/2001	F	11	5	62291	0301	F	Reg
KA10100000	UFA	STAFF ASSISTANT	Gray,Michaud	2/4/2008	F	11	1	55195	0301	F	Reg
KA10100000	UFA	Supervisory Forester (Urban)	Chapman,Jack A	12/10/2007	F	10	0	84451	0460	F	Reg
KA10100000	UFA	Supervisory Forester (Urban)	Mccully,Robert Duff	2/23/2004	F	13	0	103200	0460	F	Reg
KA10100000	UFA	Supervisory Forester (Urban)	CORLETTA,ROBERT M	7/23/2007	F	0	0	105975	0460	F	Reg
KA10110000	Program Operations Divisions	Construction Control Represent	Thurston,Jehrel A	5/15/2006	F	7	2	42445	0809	F	Reg
KA10110000	Program Operations Divisions	Forester (Urban)	Farber,Taryn	11/16/2015	F	9	1	45811	0460	F	Reg
KA10110000	Program Operations Divisions	Forester (Urban)	Pond III,John A	12/2/2013	F	11	5	62291	0460	F	Reg
KA10110000	Program Operations Divisions	Forester (Urban)	Babra,Ranjit S	3/22/2004	F	12	7	81014	0460	F	Reg
KA10110000	Program Operations Divisions	Forester (Urban)	Conlon,Joel P	2/21/2006	F	12	6	78894	0460	F	Reg
KA10110000	Program Operations Divisions	Forester (Urban)	Chuko,Michael S	10/4/2004	F	12	7	81014	0460	F	Reg
KA10110000	Program Operations Divisions	Forester (Urban)	McKindley-Ward,Steve	10/25/2010	F	11	5	62291	0460	F	Reg
KA10110000	Program Operations Divisions	Forester (Urban)	Burckle,Joseph H	10/25/2010	F	12	6	78894	0460	F	Reg
KA10110000	Program Operations Divisions	Forester (Urban)			V	12	1	68294	0460	F	Reg
KA10110000	Program Operations Divisions	Landscape Architect	Balk,Alti J	9/23/2013	F	13	4	86253	0807	F	Reg
KA10110000	Program Operations Divisions	Landscape Architect	Dendy,Sharon H	1/22/2008	F	13	6	91297	0807	F	Reg
KA10110000	Program Operations Divisions	Lead Forester (Urban)	Banua,Simoun	11/17/2003	F	13	6	91297	0460	F	Reg
KA10110000	Program Operations Divisions	Lead Forester (Urban)			V	13	1	78687	0460	F	Reg
KA10110000	Program Operations Divisions	Lead Forester (Urban)			V	13	1	78687	0460	F	Reg
KA10110000	Program Operations Divisions	Lead Forester (Urban)			V	13	1	78687	0460	F	Reg
KA10110000	Program Operations Divisions	Program Analyst	Klaphor,Carlson B	7/21/2008	F	12	10	87374	0343	F	Reg
KA10110000	Program Operations Divisions	Staff Assistant II	Lomax,Kenya M	5/10/2010	F	11	4	60517	0301	F	Reg
KA10120000	Field Operations Division	Forester (Urban)	McKim,Shaun L.	8/26/2013	F	11	5	62291	0460	F	Reg
KA10120000	Field Operations Division	Forester (Urban)	Miller,Janet Lee	8/21/2006	F	12	3	72534	0460	F	Reg
KA10120000	Field Operations Division	Forester (Urban)	Anderson,Evan	11/16/2015	F	9	1	45811	0460	F	Reg

Department ID	Department Name	Job Title	Employee Name	Hire Date	Vacant / Filled Status	Grade	Step	Salary	Series	F/P Time	Reg/Temp/Term
KA10120000	Field Operations Division	LABORER	Lindsay,Lashawn D	1/12/2009	F	3	6	39852.8	3502	F	Reg
KA10120000	Field Operations Division	Supvy Forester (Urban)	Ertem,Munevver	9/7/2004	F	13	0	100427	0460	F	Reg
KA10120000	Field Operations Division	TREE TRIMMER & REMOVER	Whalen Jr.,Donald Kenneth	4/23/2001	F	9	9	62296	5042	F	Reg
KA10120000	Field Operations Division	TREE TRIMMER & REMOVER	Dorsey,Robert	2/21/2006	F	9	7	58884.8	5042	F	Reg
KA10120000	Field Operations Division	TREE TRIMMER & REMOVER	Garcia,Mario	6/4/2001	F	9	5	55473.6	5042	F	Reg
KA10120000	Field Operations Division	TREE TRIMMER & REMOVER			V	9	1	48651.2	5042	F	Reg
KA10120000	Field Operations Division	TREE TRIMMER & REMOVER LEADER	Campbell,Nathan A	1/24/1998	F	9	8	66372.8	5042	F	Reg
KA10120000	Field Operations Division	Tree Trimmer & Remover Supvsr.	Johnson,James O	10/19/1998	F	9	10	68233	5042	F	Reg
KA10120000	Field Operations Division	Tree Trimmer and Remover	Phillips,Jimmy O	6/22/2007	F	9	7	58884.8	5042	F	Reg
KA10120000	Field Operations Division	Tree Trimmer and Remover	Leiva,Isaias	8/17/2009	F	9	5	55473.6	5042	F	Reg

Phone Number	STATUS	FUNCTION	SERVICE TYPE	VENDOR	SERVICE ADDRESS	ROOM	CONTACT	MODEL_NAME	CONTACT_NAME
2022074871	Certified as Active	Wireless Phone/Device	Cellular	AT&T Wireless	55 M STREET SE	SCG	melony.pree@dc.gov	iphone 6	melony pree
2022074890	Certified as Active	Wireless Phone/Device	Cellular	AT&T Wireless	55 M STREET SE	IPMA	Albert.Ladipoh@dc.gov	Samsung Rugby Pro	Albert Ladipoh
2022074942	Certified as Active	Wireless Phone/Device	Cellular	AT&T Wireless	1403 W STREET	SBM	Clarence.Sykes@dc.gov	Samsung Rugby Pro	Clarence Sykes
2022074975	Certified as Active	Wireless Phone/Device	Cellular	AT&T Wireless	1403 W STREET	SBM	michael.dawkins@dc.gov	Samsung S5	Michael Dawkins
2022584367	Certified as Active	Wireless Phone/Device	Cellular	AT&T Wireless	2000 14TH STREET NW	TCO	Lamar.Mcintyre@dc.gov	Note 4	Lamar McIntyre
2022622932	Certified as Active	Wireless Phone/Device	Cellular	AT&T Wireless	2000 14TH STREET NW	Crossing Guard	Ceray.Burns@dc.gov	Sonim Bolt SL	Ceray Burns
2022629470	Certified as Active	Wireless Phone/Device	Cellular	AT&T Wireless	2000 14TH STREET NW	Crossing Guard	Gail.Russell@dc.gov	Sonim Bolt SL	Gail Russell
2022704350	Certified as Active	Wireless Phone/Device	Cellular	AT&T Wireless	55 M STREET SE	TOA	john.schools@dc.gov	Samsung Rugby 3	john schools
2022769370	Certified as Active	Wireless Phone/Device	Cellular	AT&T Wireless	2000 14TH STREET NW	TCO	akia.schools@dc.gov	Samsung Rugby 3	akia schools
2022790867	Certified as Active	Wireless Phone/Device	Cellular	AT&T Wireless	55 M STREET SE	OITI	sharon.tolson@dc.gov	Samsung S5	Sharon Tolson
2022850711	Certified as Active	Wireless Phone/Device	Cellular	AT&T Wireless	55 M STREET SE	OD	jessica.headd@dc.gov	Samsung Galaxy S5	Jessica Headd
2022851525	Certified as Active	Wireless Phone/Device	Cellular	AT&T Wireless	55 M STREET SE	OITI	marlene.dixon@dc.gov	Samsung Galaxy S5	Seasonal Standby
2022852503	Certified as Active	Wireless Phone/Device	Cellular	AT&T Wireless	55 M STREET SE	OITI	david.koch@dc.gov	Samsung Galaxy S5	David Koch
2022852977	Certified as Active	Wireless Phone/Device	Cellular	AT&T Wireless	2000 14TH STREET NW	Crossing Guard	Jerome.Barnes@dc.gov	Sonim Bolt SL	Jerome Barnes
2022857159	Certified as Active	Wireless Phone/Device	Cellular	AT&T Wireless	55 M STREET SE	OITI	lisa.robinson@dc.gov	Samsung S5	Lisa Robinson
2022883806	Certified as Active	Wireless Phone/Device	Cellular	AT&T Wireless	55 M STREET SE	MTA	norman.gross@dc.gov	Samsung Galaxy S5	Norman Gross
2023044702	Certified as Active	Wireless Phone/Device	Cellular	AT&T Wireless	55 M STREET SE	Snow	melony.pree@dc.gov	Sonim XP1520	Snow #11 Phone
2023163017	Certified as Active	Wireless Phone/Device	Cellular	AT&T Wireless	55 M STREET SE	OITI	adrienne.miller@dc.gov	Samsung Rugby 3	Adrienne Miller
2023163265	Certified as Active	Wireless Phone/Device	Cellular	AT&T Wireless	2000 14TH STREET NW	TCO	Yunior.Rosario@dc.gov	Note 4	Yunior Rosario
2023415165	Certified as Active	Wireless Phone/Device	Cellular	AT&T Wireless	1100 4TH STREET SW	PSRA	kisha.allen@dc.gov	Samsung Galaxy S5	Kisha Allen
2023419416	Certified as Active	Wireless Phone/Device	Cellular	AT&T Wireless	414 FARRAGUT STREET NE	Snow	melony.pree@dc.gov	Sonim XP1520	Snow #9 Number
2023450375	Certified as Active	Wireless Phone/Device	Cellular	AT&T Wireless	2000 14TH STREET NW	SCG	crossing_guard@dc.gov	Samsung Rugby Pro	Edward Tucker
2023450447	Certified as Active	Wireless Phone/Device	Cellular	AT&T Wireless	401 FARRAGUT STREET NE	SBM	Barrington.Chappelle@dc.gov	Samsung Rugby 3	Barrington Chappelle
2023450787	Certified as Active	Wireless Phone/Device	Cellular	AT&T Wireless	1338 G STREET SE	1355-Rear Alley	leon.barnes2@dc.gov	Samsung Rugby Pro	leon barnes
2023450937	Certified as Active	Wireless Phone/Device	Cellular	AT&T Wireless	1403 W STREET	SBM	rashaad1.short@dc.gov	Samsung Rugby 3	Rashaad Short
2023450974	Certified as Active	Wireless Phone/Device	Cellular	AT&T Wireless	55 M STREET SE	IPMA	yazid.lewis@dc.gov	Samsung Rugby Pro	Yazid Lewis
2023456032	Certified as Active	Wireless Phone/Device	Cellular	AT&T Wireless	55 M STREET SE	UFA	sharon.dendy2@dc.gov	iphone 6	Sharon Dendy
2023456407	Certified as Active	Wireless Phone/Device	Cellular	AT&T Wireless	1403 W STREET	SBM	eugene.love@dc.gov	Samsung Rugby 3	Eugene Love
2023456633	Certified as Active	Wireless Phone/Device	Cellular	AT&T Wireless	2000 14TH STREET NW	ITS-TMC	Monroe.Hall@dc.gov	Samsung Rugby Pro	Monroe Hall
202354057	Certified as Active	Wireless Phone/Device	Cellular	AT&T Wireless	55 M STREET SE	OITI	Jordan.Washington@dc.gov	Samsung S5	Jordan Washington
202354298	Certified as Active	Wireless Phone/Device	Cellular	AT&T Wireless	55 M STREET SE	OD	Jasmine.Miller@dc.gov	Sonim Bolt SL	Jasmine Miller
2023558278	Certified as Active	Wireless Phone/Device	Cellular	AT&T Wireless	55 M STREET SE	OITI	marlene.dixon@dc.gov	Samsung Galaxy S4	Seasonal Standby
2023590027	Certified as Active	Wireless Phone/Device	Cellular	AT&T Wireless	2000 14TH STREET NW	TCO/SCG	latoya.holloman@dc.gov	Sonim Bolt SL	Latoya Holloman
2023590038	Certified as Active	Wireless Phone/Device	Cellular	AT&T Wireless	55 M STREET SE	OITI	Sean.Canning@dc.gov	Sonim Bolt SL	Sean Canning
2023590045	Certified as Active	Wireless Phone/Device	Cellular	AT&T Wireless	280 MCMILLAN DRIVE NW	IPMA - QA/QC La	michael.schneider@dc.gov	Samsung Rugby 3	Michael Schneider
2023590053	Certified as Active	Wireless Phone/Device	Cellular	AT&T Wireless	1338 G STREET SE	FOD	phillip.daniel@dc.gov	Samsung Rugby Pro	Phillip Daniels
2023590069	Certified as Active	Wireless Phone/Device	Cellular	AT&T Wireless	2000 14TH STREET NW	SCG	Amber.fields@dc.gov	Samsung Rugby Pro	Amber Fields
2023590094	Certified as Active	Wireless Phone/Device	Cellular	AT&T Wireless	2000 14TH STREET NW	SCG	Kayola.Ashton@dc.gov	Sonim Bolt SL	Kayola Ashton
2023590126	Certified as Active	Wireless Phone/Device	Cellular	AT&T Wireless	1735 15TH STREET NE	Rope	carlos.barksdale@dc.gov	ATT Mobile Hotspot MIFI Liberate	Carlos Barksdale
2023590168	Certified as Active	Wireless Phone/Device	Cellular	AT&T Wireless	55 M STREET SE	TOA	Kim.Muldrow@dc.gov	Samsung Galaxy S5	Kim Muldrow
2023590211	Certified as Active	Wireless Phone/Device	Cellular	AT&T Wireless	2000 14TH STREET NW	TCO	Shaheda.brooks@dc.gov	Sonim Bolt SL	Shaheda Brooks
2023590215	Certified as Active	Wireless Phone/Device	Cellular	AT&T Wireless	55 M STREET SE	TOA	Gregory.Shorter@dc.gov	Sonim Bolt SL	Gregory Shorter
2023590247	Certified as Active	Wireless Phone/Device	Cellular	AT&T Wireless	55 M STREET SE	LEAP Program	mohammed.sesay@dc.gov	Samsung Galaxy S5	Mohammed Sesay
2023590284	Certified as Active	Wireless Phone/Device	Cellular	AT&T Wireless	2000 14TH STREET NW	SCG	Shaughn.donley@dc.gov	Samsung Rugby 3	Shaughn Donley
2023590327	Certified as Active	Wireless Phone/Device	Cellular	AT&T Wireless	55 M STREET SE	TOA	Rahul.Jain@dc.gov	Samsung Rugby Pro	Rahul Jain
2023590360	Certified as Active	Wireless Phone/Device	Cellular	AT&T Wireless	2000 14TH STREET NW	TCO	michael.hall@dc.gov	Samsung Rugby 3	Michael Hall
2023590403	Certified as Active	Wireless Phone/Device	Cellular	AT&T Wireless	55 M STREET SE	IPMA	Charles.Umezurike@dc.gov	Samsung Rugby Pro	Charles Umezurike
2023590407	Certified as Active	Wireless Phone/Device	Cellular	AT&T Wireless	1403 W STREET	SBM	matthew.coates@dc.gov	Samsung S5	Matthew Coates

Phone Number	STATUS	FUNCTION	SERVICE TYPE	VENDOR	SERVICE ADDRESS	ROOM	CONTACT	MODEL_NAME	CONTACT_NAME
2023590423	Certified as Active	Wireless Phone/Device	Cellular	AT&T Wireless	2000 14TH STREET NW	SCG	regina.green@dc.gov	Sonim XP5560	Regina Green
2023590440	Certified as Active	Wireless Phone/Device	Cellular	AT&T Wireless	414 FARRAGUT STREET NE	Snow	melony.pree@dc.gov	Sonim XP1520	Snow #21 Phone
2023590446	Certified as Active	Wireless Phone/Device	Cellular	AT&T Wireless	55 M STREET SE	IPMA	Paul.hoffman@dc.gov	Samsung Rugby Pro	Paul Hoffman
2023590477	Certified as Active	Wireless Phone/Device	Cellular	AT&T Wireless	2000 14TH STREET NW	SCG	Angela.lee3@dc.gov	Samsung Rugby 3	Angela Lee
2023590481	Certified as Active	Wireless Phone/Device	Cellular	AT&T Wireless	55 M STREET SE	IPMA	Keith.foxx@dc.gov	Samsung Galaxy S5	Keith Fox
2023590489	Certified as Active	Wireless Phone/Device	Cellular	AT&T Wireless	2000 14TH STREET NW	TCO	wanda.beeks@dc.gov	Samsung Rugby 3	Wanda Beeks
2023590498	Certified as Active	Wireless Phone/Device	Cellular	AT&T Wireless	1100 4TH STREET SW	Permit	quita.somerville@dc.gov	Samsung Galaxy S5	Quita Somerville
2023590510	Certified as Active	Wireless Phone/Device	Cellular	AT&T Wireless	2000 14TH STREET NW	SCG	michael.ford@dc.gov	Samsung Rugby 3	Michael Ford Sr
2023590532	Certified as Active	Wireless Phone/Device	Cellular	AT&T Wireless	55 M STREET SE	FOD	ivah.dennis@dc.gov	Samsung Rugby 3	I'vah Dennis
2023590540	Certified as Active	Wireless Phone/Device	Cellular	AT&T Wireless	2000 14TH STREET NW	SCG's	karyn.alford@dc.gov	Samsung Rugby 3	Karyn Alford
2023590541	Certified as Active	Wireless Phone/Device	Cellular	AT&T Wireless	2000 14TH STREET NW	TOA/TCO	marques.johnson@dc.gov	Samsung Rugby 3	Marques Johnson
2023590582	Certified as Active	Wireless Phone/Device	Cellular	AT&T Wireless	2000 14TH STREET NW	SCG	charlene.williams@dc.gov	Samsung Rugby 3	charlene Williams
2023590597	Certified as Active	Wireless Phone/Device	Cellular	AT&T Wireless	1735 15TH STREET NE	Fleet Operation	Clement.smith@dc.gov	Samsung Rugby Pro	Clement Smith
2023590604	Certified as Active	Wireless Phone/Device	Cellular	AT&T Wireless	1403 W STREET	SBM	douglas.young@dc.gov	Sonim Bolt SL	Douglas Young
2023590609	Certified as Active	Wireless Phone/Device	Cellular	AT&T Wireless	2000 14TH STREET NW	TCO	arpell.haggins@dc.gov	Samsung Rugby 3	Arpell Haggins
2023590627	Certified as Active	Wireless Phone/Device	Cellular	AT&T Wireless	1403 W STREET	SBM	Derrick.brown@dc.gov	Samsung S5	Derrick brown
2023590634	Certified as Active	Wireless Phone/Device	Cellular	AT&T Wireless	1403 W STREET	SBM	Lorenzo.miller@dc.gov	Samsung Rugby 3	Lorenzo Miller
2023590660	Certified as Active	Wireless Phone/Device	Cellular	AT&T Wireless	1338 G STREET SE	FOD	AnthonyL.jones@dc.gov	Samsung Rugby 3	Anthony L Jones
2023590713	Certified as Active	Wireless Phone/Device	Cellular	AT&T Wireless	55 M STREET SE	TOA	Merika.Tapp@dc.gov	Iphone 4S	Merika Tapp
2023590720	Certified as Active	Wireless Phone/Device	Cellular	AT&T Wireless	414 FARRAGUT STREET NE	TOA/SBM	Celicia.marshall@dc.gov	Samsung Rugby 3	Celicia Marshall
2023590724	Certified as Active	Wireless Phone/Device	Cellular	AT&T Wireless	55 M STREET SE	DDOT/PSRA	Dirk.craig@dc.gov	Samsung Rugby Pro	Dirk Craig
2023590729	Certified as Active	Wireless Phone/Device	Cellular	AT&T Wireless	2000 14TH STREET NW	SCG	CAROLE.PRATHER-WILSON@dc.gov	Sonim Bolt SL	CAROLE PRATHER-WILSON
2023590730	Certified as Active	Wireless Phone/Device	Cellular	AT&T Wireless	55 M STREET SE	OITI	Andrew.Kaufmann@dc.gov	Samsung Galaxy S5	Andrew Kaufmann
2023590743	Certified as Active	Wireless Phone/Device	Cellular	AT&T Wireless	2000 14TH STREET NW	TOA/TCO	glen.walker@dc.gov	Samsung Rugby 3	Glen Walker
2023590777	Certified as Active	Wireless Phone/Device	Cellular	AT&T Wireless	1100 4TH STREET SW	Permitting Ofc	Curtis.pearson@dc.gov	Samsung Rugby Pro	Curtis Pearson
2023590797	Certified as Active	Wireless Phone/Device	Cellular	AT&T Wireless	55 M STREET SE	OCFO	gary.ashley@dc.gov	Samsung Rugby 3	gary ashley
2023590799	Certified as Active	Wireless Phone/Device	Cellular	AT&T Wireless	55 M STREET SE	IPMA	kyle.ohlson@dc.gov	Samsung S5	Kyle Ohlson
2023590808	Certified as Active	Wireless Phone/Device	Cellular	AT&T Wireless	2000 14TH STREET NW	SCG	emma.royster@dc.gov	Samsung Rugby 3	Emma Royster
2023590822	Certified as Active	Wireless Phone/Device	Cellular	AT&T Wireless	2000 14TH STREET NW	SCG	Sheila.walker@dc.gov	Samsung Rugby 3	Sheila Walker
2023592593	Certified as Active	Wireless Phone/Device	Cellular	AT&T Wireless	2000 14TH STREET NW	OITI	Charles.Blondheim@dc.gov	Samsung Rugby 3	Charles Blondheim
2023595143	Certified as Active	Wireless Phone/Device	Cellular	AT&T Wireless	2000 14TH STREET NW	SCG	jenita.johnson@dc.gov	Samsung Rugby 3	Jenita Johnson
2023595267	Certified as Active	Wireless Phone/Device	Cellular	AT&T Wireless	55 M STREET SE	Permits	Michael.Jernagin@dc.gov	Samsung Rugby Pro	Michael Jernagin
2023595275	Certified as Active	Wireless Phone/Device	Cellular	AT&T Wireless	1338 G STREET SE	G ST SE	Corbin.patterson@dc.gov	Samsung Galaxy S5	Corbin Patterson
2023595311	Certified as Active	Wireless Phone/Device	Cellular	AT&T Wireless	414 FARRAGUT STREET NE	Snow	melony.pree@dc.gov	Sonim XP1520	Snow #22 Phone
2023595382	Certified as Active	Wireless Phone/Device	Cellular	AT&T Wireless	55 M STREET SE	SCG	Carol.Holley@dc.gov	Samsung Rugby Pro	Carol Holley
2023595474	Certified as Active	Wireless Phone/Device	Cellular	AT&T Wireless	2000 14TH STREET NW	Basement 1	janet.flemings@dc.gov	Samsung Rugby 3	Janet Flemings
2023595630	Certified as Active	Wireless Phone/Device	Cellular	AT&T Wireless	2000 14TH STREET NW	SCG	cheryl.summers@dc.gov	Samsung Rugby 3	cheryl summers
2023595644	Certified as Active	Wireless Phone/Device	Cellular	AT&T Wireless	55 M STREET SE	TOA	Babatunde.Adeyemo@dc.gov	Samsung Rugby Pro	Babatunde Adeyemo
2023595702	Certified as Active	Wireless Phone/Device	Cellular	AT&T Wireless	1403 W STREET	SBM	Andrea.Williams2@dc.gov	Samsung S5	Andrea Williams
2023595814	Certified as Active	Wireless Phone/Device	Cellular	AT&T Wireless	55 M STREET SE	UFA	Earl.Eutsler@dc.gov	iphone 6S	Earl Eutsler
2023595820	Certified as Active	Wireless Phone/Device	Cellular	AT&T Wireless	1338 G STREET SE	Facilities	gregg.steverson@dc.gov	Samsung Rugby Pro	Gregg Steverson
2023595845	Certified as Active	Wireless Phone/Device	Cellular	AT&T Wireless	55 M STREET SE	TOA	james.cheeks@dc.gov	iphone 6S	James Cheeks
2023595855	Certified as Active	Wireless Phone/Device	Cellular	AT&T Wireless	55 M STREET SE	Asset Managame	Lakiera.Spicer@dc.gov	Samsung S5	Lakiera Spicer
2023595925	Certified as Active	Wireless Phone/Device	Cellular	AT&T Wireless	55 M STREET SE	IPMA	denis.darbela@dc.gov	Samsung S5	Denis D'Arbela
2023595926	Certified as Active	Wireless Phone/Device	Cellular	AT&T Wireless	55 M STREET SE	IPMA	Dawit.kebede@dc.gov	Samsung S5	Dawit Kebede
2023595935	Certified as Active	Wireless Phone/Device	Cellular	AT&T Wireless	2000 14TH STREET NW	SBM	Earl.garnett@dc.gov	Samsung Rugby 3	Earl Garnett
2023595940	Certified as Active	Wireless Phone/Device	Cellular	AT&T Wireless	55 M STREET SE	0	thomas.harris@dc.gov	Samsung Galaxy S5	Thomas Harris
2023595992	Certified as Active	Wireless Phone/Device	Cellular	AT&T Wireless	2000 14TH STREET NW	TCO	jason.godfrey@dc.gov	Note 4	TCO 1 Ticket Writer
2023596132	Certified as Active	Wireless Phone/Device	Cellular	AT&T Wireless	55 M STREET SE	PTSA	amy.liang@dc.gov	Samsung Rugby Pro	Amy Liang
2023596307	Certified as Active	Wireless Phone/Device	Cellular	AT&T Wireless	2000 14TH STREET NW	TOA	jason.godfrey@dc.gov	Note 4	TCO 2 Ticket Writer
2023596375	Certified as Active	Wireless Phone/Device	Cellular	AT&T Wireless	1338 G STREET SE	TOA-ITS	Reginald.Carmichael@dc.gov	Samsung Rugby Pro	Reginald Carmichael
2023596461	Certified as Active	Wireless Phone/Device	Cellular	AT&T Wireless	2000 14TH STREET NW	TOA Deputy Chief	zahid.chaudhry@dc.gov	Samsung Rugby Pro	zahid Chaudhry
2023596497	Certified as Active	Wireless Phone/Device	Cellular	AT&T Wireless	1100 4TH STREET SW	PSRA	Matthew.marcou@dc.gov	iPhone 5	Matthew Marcou
2023596546	Certified as Active	Wireless Phone/Device	Cellular	AT&T Wireless	2000 14TH STREET NW	TOA/TCO	ronnie.laster@dc.gov	Samsung Rugby 3	Ronnie Laster
2023596608	Certified as Active	Wireless Phone/Device	Cellular	AT&T Wireless	55 M STREET SE	OITI	howard.bethea@dc.gov	Samsung Rugby Pro	Howard Bethea
2023596880	Certified as Active	Wireless Phone/Device	Cellular	AT&T Wireless	2000 14TH STREET NW	SCG	jacqueline.brown@dc.gov	Samsung Rugby 3	Jacqueline Brown
2023596898	Certified as Active	Wireless Phone/Device	Cellular	AT&T Wireless	55 M STREET SE	IPMA	Ohene.Ofosu@dc.gov	Kyocera Device	Ohene Ofosu

Phone Number	STATUS	FUNCTION	SERVICE TYPE	VENDOR	SERVICE ADDRESS	ROOM	CONTACT	MODEL_NAME	CONTACT_NAME
2023596937	Certified as Active	Wireless Phone/Device	Cellular	AT&T Wireless	2000 14TH STREET NW	TOA/SCG	crossing.guard@dc.gov	Samsung Rugby 3	Daniel Wilder
2023680454	Certified as Active	Wireless Phone/Device	Cellular	AT&T Wireless	55 M STREET SE	TOA cubicle 633	ashley.callahan@dc.gov	Samsung S5	Ashley Callahan
2023682435	Certified as Active	Wireless Phone/Device	Cellular	AT&T Wireless	414 FARRAGUT STREET NE	SBM	Laurita.Ajagba@dc.gov	Samsung Galaxy S5	Laurita Ajagba
2023738273	Certified as Active	Wireless Phone/Device	Cellular	AT&T Wireless	55 M STREET SE	TOA	JASON.TAO@dc.gov	Samsung Rugby Pro	Jason Tao
2023945528	Certified as Active	Wireless Phone/Device	Cellular	AT&T Wireless	55 M STREET SE	OITI	tarita.spencer@dc.gov	Samsung Galaxy S5	Tarita Spencer
2023945627	Certified as Active	Wireless Phone/Device	Cellular	AT&T Wireless	55 M STREET SE	OITI	marlene.dixon@dc.gov	Samsung Galaxy S5	Seasonal Standby
2023945628	Certified as Active	Wireless Phone/Device	Cellular	AT&T Wireless	55 M STREET SE	LEAP	michael.nelson@dc.gov	Samsung Galaxy S5	Michael Nelson
2023945629	Certified as Active	Wireless Phone/Device	Cellular	AT&T Wireless	414 FARRAGUT STREET NE	OITI	Terrl.Holman@dc.gov	Samsung Galaxy S5	Terrl Holman
2023945631	Certified as Active	Wireless Phone/Device	Cellular	AT&T Wireless	55 M STREET SE	OITI	marlene.dixon@dc.gov	Samsung Galaxy S5	Seasonal Standby
2023945634	Certified as Active	Wireless Phone/Device	Cellular	AT&T Wireless	55 M STREET SE	OITI	marlene.dixon@dc.gov	Samsung Galaxy S5	Seasonal Standby
2024092316	Certified as Active	Wireless Phone/Device	Cellular	AT&T Wireless	55 M STREET SE	IPMA	Ali.shakeri@dc.gov	Samsung Rugby Pro	Ali Shakeri
2024092856	Certified as Active	Wireless Phone/Device	Cellular	AT&T Wireless	2000 14TH STREET NW	SCG	joseph.powell2@dc.gov	Samsung Rugby 3	Joseph Powell
2024125869	Certified as Active	Wireless Phone/Device	Cellular	AT&T Wireless	1735 15TH STREET NE	TOA	adrian.bulluck@dc.gov	Samsung Rugby Pro	Adrian Bulluck
2024231022	Certified as Active	Wireless Phone/Device	Cellular	AT&T Wireless	2000 14TH STREET NW	SCG	rockelle.smith@dc.gov	Samsung Rugby 3	Rockelle Smith
2024231147	Certified as Active	Wireless Phone/Device	Cellular	AT&T Wireless	55 M STREET SE	IPMA	Alexander.Okechukwu@dc.gov	Samsung Rugby Pro	Alexander Okechukwu
2024231158	Certified as Active	Wireless Phone/Device	Cellular	AT&T Wireless	2000 14TH STREET NW	SCG	moses.brown@dc.gov	Samsung Rugby 3	Moses Brown
2024231306	Certified as Active	Wireless Phone/Device	Cellular	AT&T Wireless	2000 14TH STREET NW	SCG	rosalind.tymus@dc.gov	Samsung Rugby 3	Rosalind Tymus
2024231501	Certified as Active	Wireless Phone/Device	Cellular	AT&T Wireless	2000 14TH STREET NW	SCG	laquanta.graham@dc.gov	Samsung Rugby 3	LaQuanta Graham
2024231589	Certified as Active	Wireless Phone/Device	Cellular	AT&T Wireless	2000 14TH STREET NW	PSRA	aisha.thomas@dc.gov	Samsung S5	Aisha Thomas
2024231632	Certified as Active	Wireless Phone/Device	Cellular	AT&T Wireless	2000 14TH STREET NW	SCG	gracie.brown@dc.gov	Samsung Rugby 3	Gracie Brown
2024231649	Certified as Active	Wireless Phone/Device	Cellular	AT&T Wireless	55 M STREET SE	TOA	donna.mccrea@dc.gov	Samsung Galaxy S5	Donna Mccrea
2024231724	Certified as Active	Wireless Phone/Device	Cellular	AT&T Wireless	2000 14TH STREET NW	TOA	jason.godfrey@dc.gov	Note 4	TCO 5 Ticket Writer
2024231799	Certified as Active	Wireless Phone/Device	Cellular	AT&T Wireless	2000 14TH STREET NW	SCG	sarah.butler@dc.gov	Samsung Rugby 3	Sarah Butler
2024231813	Certified as Active	Wireless Phone/Device	Cellular	AT&T Wireless	1403 W STREET NE	SBM	brenda.johnson@dc.gov	Samsung S5	Brenda Johnson
2024231860	Certified as Active	Wireless Phone/Device	Cellular	AT&T Wireless	1403 W STREET	SBM	Michael.mims@dc.gov	Samsung S5	michael mims
2024231866	Certified as Active	Wireless Phone/Device	Cellular	AT&T Wireless	55 M STREET SE	0	kipchogie.brooks@dc.gov	Samsung Rugby Pro	Kipchogie Brooks
2024231898	Certified as Active	Wireless Phone/Device	Cellular	AT&T Wireless	2000 14TH STREET NW	SCG	crossing.guard@dc.gov	Samsung Rugby 3	Darlene Reeder
2024231922	Certified as Active	Wireless Phone/Device	Cellular	AT&T Wireless	55 M STREET SE	0	april.thomas@dc.gov	Sonim Bolt SL	April Thomas
2024231930	Certified as Active	Wireless Phone/Device	Cellular	AT&T Wireless	1100 4TH STREET SW	PSRA	Lanel.Sartin@dc.gov	iphone 6	Lanel Sartin
2024231968	Certified as Active	Wireless Phone/Device	Cellular	AT&T Wireless	55 M STREET SE	ADA Coordinator	Cesar.Barreto@dc.gov	Samsung S5	Cesar Barreto
2024233203	Certified as Active	Wireless Phone/Device	Cellular	AT&T Wireless	2000 14TH STREET NW	SCG	renice.sutton@dc.gov	Sonim Bolt SL	Renice Sutton
2024236033	Certified as Active	Wireless Phone/Device	Cellular	AT&T Wireless	2000 14TH STREET NW	SCG	crossing.guard@dc.gov	Samsung Rugby 3	Robin Ward
2024236043	Certified as Active	Wireless Phone/Device	Cellular	AT&T Wireless	1403 W STREET	SBM	George.miller@dc.gov	Samsung Galaxy S5	George Miller
2024236046	Certified as Active	Wireless Phone/Device	Cellular	AT&T Wireless	55 M STREET SE	OITI	marlene.dixon@dc.gov	Samsung Rugby Pro	Under Investigation Spare
2024236056	Certified as Active	Wireless Phone/Device	Cellular	AT&T Wireless	1403 W STREET	SBM	Bradley.murchison@dc.gov	Samsung Rugby 3	Bradley Murchinson
2024236071	Certified as Active	Wireless Phone/Device	Cellular	AT&T Wireless	2000 14TH STREET NW	SCG	James.hunter@dc.gov	Samsung Rugby 3	James Hunter
2024236157	Certified as Active	Wireless Phone/Device	Cellular	AT&T Wireless	414 FARRAGUT STREET NE	Snow	melony.pree@dc.gov	Sonim XP1520	Snow #10 Phone
2024236192	Certified as Active	Wireless Phone/Device	Cellular	AT&T Wireless	2000 14TH STREET NW	OITI	James.Benton@dc.gov	Samsung Galaxy S5	James Benton
2024236232	Certified as Active	Wireless Phone/Device	Cellular	AT&T Wireless	2000 14TH STREET NW	SCG	crossing.guard@dc.gov	Samsung Galaxy S5	Rochelle Gibbson
2024236264	Certified as Active	Wireless Phone/Device	Cellular	AT&T Wireless	1100 4TH STREET SW	TCO	Arielle.baumgardner@dc.gov	Sonim Bolt SL	Arielle' Baumgardner
2024236266	Certified as Active	Wireless Phone/Device	Cellular	AT&T Wireless	1403 W STREET	SBM	James.Whren@dc.gov	Samsung Rugby Pro	James Whren
2024236269	Certified as Active	Wireless Phone/Device	Cellular	AT&T Wireless	1735 15TH STREET NE	ROPE	tyrone.skeen@dc.gov	Samsung Rugby Pro	Tyrone Skeen
2024236308	Certified as Active	Wireless Phone/Device	Cellular	AT&T Wireless	2000 14TH STREET NW	SCG	Tan-eka.sharpe@dc.gov	Samsung Rugby 3	Tan-Eka Sharpe
2024236313	Certified as Active	Wireless Phone/Device	Cellular	AT&T Wireless	414 FARRAGUT STREET NE	Snow	melony.pree@dc.gov	Sonim XP1520	Snow #15 Phone
2024236317	Certified as Active	Wireless Phone/Device	Cellular	AT&T Wireless	2000 14TH STREET NW	TCO	Geneva.branch@dc.gov	Samsung Rugby 3	Geneva Branch
2024236318	Certified as Active	Wireless Phone/Device	Cellular	AT&T Wireless	55 M STREET SE	General Counsel	Michael.oconnell@dc.gov	Samsung S5	Michael O'Connell
2024236330	Certified as Active	Wireless Phone/Device	Cellular	AT&T Wireless	414 FARRAGUT STREET NE	Snow	melony.pree@dc.gov	Sonim XP1520	Snow phone
2024236344	Certified as Active	Wireless Phone/Device	Cellular	AT&T Wireless	55 M STREET SE	PTSA	Othman.chebli@dc.gov	Samsung S5	Othman chebli
2024236357	Certified as Active	Wireless Phone/Device	Cellular	AT&T Wireless	2000 14TH STREET NW	SCG/TCO	jason.godfrey@dc.gov	Note 4	TCO 9 Ticket Writer
2024236359	Certified as Active	Wireless Phone/Device	Cellular	AT&T Wireless	2000 14TH STREET NW	TCO	jason.godfrey@dc.gov	Note 4	TCO 10 Ticket Writer
2024236360	Certified as Active	Wireless Phone/Device	Cellular	AT&T Wireless	2000 14TH STREET NW	SCG	yetta.gray@dc.gov	Samsung Rugby 3	Yetta Gray
2024236392	Certified as Active	Wireless Phone/Device	Cellular	AT&T Wireless	414 FARRAGUT STREET NE	TCO	melony.pree@dc.gov	Sonim XP1520	Snow #14 Number
2024236427	Certified as Active	Wireless Phone/Device	Cellular	AT&T Wireless	55 M STREET SE	OCFO	aaron.lancaster@dc.gov	Samsung Rugby 3	Aaron Lancaster
2024236471	Certified as Active	Wireless Phone/Device	Cellular	AT&T Wireless	2000 14TH STREET NW	TOA/SCG	millicent.harris@dc.gov	Samsung Rugby 3	Millicent Harris
2024236480	Certified as Active	Wireless Phone/Device	Cellular	AT&T Wireless	55 M STREET SE	OD	lakisha.love@dc.gov	Samsung Galaxy S5	Lakisha Love
2024236514	Certified as Active	Wireless Phone/Device	Cellular	AT&T Wireless	2000 14TH STREET NW	SCG	crossing.guard@dc.gov	Samsung Rugby Pro	Tate Thomas
2024236522	Certified as Active	Wireless Phone/Device	Cellular	AT&T Wireless	55 M STREET SE	TOA	Evian.patterson@dc.gov	Samsung Rugby Pro	Evian Patterson

Phone Number	STATUS	FUNCTION	SERVICE TYPE	VENDOR	SERVICE ADDRESS	ROOM	CONTACT	MODEL_NAME	CONTACT_NAME
2024236542	Certified as Active	Wireless Phone/Device	Cellular	AT&T Wireless	414 FARRAGUT STREET NE	Snow	melony.pree@dc.gov	Sonim XP1520	Snow #18 Number
2024236545	Certified as Active	Wireless Phone/Device	Cellular	AT&T Wireless	2000 14TH STREET NW	TOA/TCO	Lajuan.Simpson@dc.gov	Samsung Rugby 3	Lajuan Simpson
2024236631	Certified as Active	Wireless Phone/Device	Cellular	AT&T Wireless	2000 14TH STREET NW	SCG	kay.deloatch@dc.gov	Samsung Rugby 3	Kay Deloatch
2024236640	Certified as Active	Wireless Phone/Device	Cellular	AT&T Wireless	55 M STREET SE	OD	Sterling.Grant-Jones@dc.gov	Samsung S5	Sterling Grant-Jones
2024236644	Certified as Active	Wireless Phone/Device	Cellular	AT&T Wireless	1403 W STREET NE	UFA	isaias.leiva@dc.gov	Samsung Rugby 3	Isaias Leiva
2024236667	Certified as Active	Wireless Phone/Device	Cellular	AT&T Wireless	2000 14TH STREET NW	SCG	kareema.thomas@dc.gov	Samsung Rugby 3	Kareema Thomas
2024236692	Certified as Active	Wireless Phone/Device	Cellular	AT&T Wireless	2000 14TH STREET NW	TCO	jason.godfrey@dc.gov	Note 4	TCO 12 Ticket Writer
2024236696	Certified as Active	Wireless Phone/Device	Cellular	AT&T Wireless	2000 14TH STREET NW	SCG	marsha.mayo@dc.gov	Samsung Rugby 3	Marsha Mayo
2024236741	Certified as Active	Wireless Phone/Device	Cellular	AT&T Wireless	1403 W STREET NE	SBM	michael.brown6@dc.gov	Samsung S5	Michael Brown
2024236749	Certified as Active	Wireless Phone/Device	Cellular	AT&T Wireless	2000 14TH STREET NW	SCG	jason.godfrey@dc.gov	Note 4	TCO 13 Ticket Writer
2024236764	Certified as Active	Wireless Phone/Device	Cellular	AT&T Wireless	55 M STREET SE	0	john.duel@dc.gov	Samsung S5	John Duel
2024236782	Certified as Active	Wireless Phone/Device	Cellular	AT&T Wireless	414 FARRAGUT STREET NE	Snow	melony.pree@dc.gov	Sonim XP1520	Snow Phone
2024236801	Certified as Active	Wireless Phone/Device	Cellular	AT&T Wireless	55 M STREET SE	Training	Nicole.Forgy@dc.gov	Samsung Rugby Pro	Nicole Forgy
2024236804	Certified as Active	Wireless Phone/Device	Cellular	AT&T Wireless	2000 14TH STREET NW	SCG	Lashawn.wilson@dc.gov	Samsung Rugby 3	Lashawn Wilson
2024236877	Certified as Active	Wireless Phone/Device	Cellular	AT&T Wireless	414 FARRAGUT STREET NE	Snow	melony.pree@dc.gov	Sonim XP1520	Snow #24 Phone
2024236931	Certified as Active	Wireless Phone/Device	Cellular	AT&T Wireless	2000 14TH STREET NW	Crossing Guard	tachelle.watts@dc.gov	Sonim Bolt SL	Tachelle Watts
2024236938	Certified as Active	Wireless Phone/Device	Cellular	AT&T Wireless	414 FARRAGUT STREET NE	SBM	reginald.mathis@dc.gov	Samsung Rugby Pro	reginald mathis
2024236944	Certified as Active	Wireless Phone/Device	Cellular	AT&T Wireless	2000 14TH STREET NW	SCG	crossing_guard@dc.gov	Samsung Rugby 3	Yolanda Coleman
2024236991	Certified as Active	Wireless Phone/Device	Cellular	AT&T Wireless	2000 14TH STREET NW	TCO	jason.godfrey@dc.gov	Note 4	TCO 14 Ticket Writer
2024237318	Certified as Active	Wireless Phone/Device	Cellular	AT&T Wireless	55 M STREET SE	PTSA	angelica.johnson@dc.gov	Samsung Rugby 3	Angelica Johnson
2024253453	Certified as Active	Wireless Phone/Device	Cellular	AT&T Wireless	55 M STREET SE	IPMA	Adrian.moon@dc.gov	Samsung Rugby Pro	Adrian Moon
2024279477	Certified as Active	Wireless Phone/Device	Cellular	AT&T Wireless	55 M STREET SE	OITI	jason.godfrey@dc.gov	Note 4	TCO 15 Ticket Writer
2024313198	Certified as Active	Wireless Phone/Device	Cellular	AT&T Wireless	2000 14TH STREET NW	TCO	Anthony.Lancaster@dc.gov	Note 4	Anthony Lancaster
2024370410	Certified as Active	Wireless Phone/Device	Cellular	AT&T Wireless	2000 14TH STREET NW	SCG	muriel.weathington@dc.gov	Samsung Rugby 3	Muriel Weathington
2024370460	Certified as Active	Wireless Phone/Device	Cellular	AT&T Wireless	55 M STREET SE	IPMA	Akiliu.habtemariam@dc.gov	Samsung S5	Akiliu Habtemariam
2024370605	Certified as Active	Wireless Phone/Device	Cellular	AT&T Wireless	2000 14TH STREET NW	SCG	April.nickens@dc.gov	Samsung 1730	April Nickens
2024370943	Certified as Active	Wireless Phone/Device	Cellular	AT&T Wireless	2000 14TH STREET NW	SCG	shanika.horton@dc.gov	Samsung Rugby 3	Shanika Horton
2024371070	Certified as Active	Wireless Phone/Device	Cellular	AT&T Wireless	1100 4TH STREET SW	PSRA	Jeffrey.powell@dc.gov	Samsung Rugby Pro	PSRA-MPD On-call PSRA-MPD On-call
2024371137	Certified as Active	Wireless Phone/Device	Cellular	AT&T Wireless	55 M STREET SE	OD	bettye.ward@dc.gov	Samsung S5	Bettye Ward
2024371249	Certified as Active	Wireless Phone/Device	Cellular	AT&T Wireless	2000 14TH STREET NW	SCG	bernita.allen@dc.gov	Samsung Rugby Pro	bernita allen
2024375559	Certified as Active	Wireless Phone/Device	Cellular	AT&T Wireless	2000 14TH STREET NW	TCO	Lamont.dial@dc.gov	Sonim Bolt SL	Lamont Dial
2024384055	Certified as Active	Wireless Phone/Device	Cellular	AT&T Wireless	400 MCMILLAN DRIVE NW	IPMA- QAQC	Elmi.nur@dc.gov	Samsung S5	Elmi Nur
2024384083	Certified as Active	Wireless Phone/Device	Cellular	AT&T Wireless	55 M STREET SE	PPSA	jonathan.rogers2@dc.gov	Sonim Bolt SL	Jonathan Rogers
2024384134	Certified as Active	Wireless Phone/Device	Cellular	AT&T Wireless	55 M STREET SE	OITI	Deborah.monts@dc.gov	Samsung Rugby 3	Deborah Monts
2024388043	Certified as Active	Wireless Phone/Device	Cellular	AT&T Wireless	2000 14TH STREET NW	TOA	Barry.Baucum@dc.gov	Samsung Rugby 3	Barry Baucum
2024390586	Certified as Active	Wireless Phone/Device	Cellular	AT&T Wireless	2000 14TH STREET NW	2nd FL	Eugene.Patrick@dc.gov	Samsung S5	Eugene Patrick
2024391902	Certified as Active	Wireless Phone/Device	Cellular	AT&T Wireless	1403 W STREET	SBM	jason.godfrey@dc.gov	Note 4	TCO 18 Ticket Writer
2024459348	Certified as Active	Wireless Phone/Device	Cellular	AT&T Wireless	414 FARRAGUT STREET NE	Snow	melony.pree@dc.gov	Sonim XP1520	Snow #26 Phone
2024464083	Certified as Active	Wireless Phone/Device	Cellular	AT&T Wireless	55 M STREET SE	Civil Rights	Karen.Randolph@dc.gov	Kyocera Device	Karen Randolph
2024659524	Certified as Active	Wireless Phone/Device	Cellular	AT&T Wireless	55 M STREET SE	PSRA	james.childs@dc.gov	Samsung S5	James Childs
2024865018	Certified as Active	Wireless Phone/Device	Cellular	AT&T Wireless	2000 14TH STREET NW	TCO	jason.godfrey@dc.gov	Note 4	TCO 19 Ticket Writer
2024865439	Certified as Active	Wireless Phone/Device	Cellular	AT&T Wireless	401 FARRAGUT STREET NE	SBM	Clifton.johnson@dc.gov	Samsung Rugby 3	Clifton Johnson
2024970046	Certified as Active	Wireless Phone/Device	Cellular	AT&T Wireless	55 M STREET SE	PPSA	jamie.henson@dc.gov	Samsung Galaxy S5	Jamie Henson
2024970079	Certified as Active	Wireless Phone/Device	Cellular	AT&T Wireless	414 FARRAGUT STREET NE	Sreet Bridge/MV	Armell.Gaines@dc.gov	SAMSUNG SGH-i607 AT&T	Armell Gaines
2024970090	Certified as Active	Wireless Phone/Device	Cellular	AT&T Wireless	55 M STREET SE	PPSA	Darren.buck@dc.gov	Samsung Rugby Pro	Darren Buck
2024970099	Certified as Active	Wireless Phone/Device	Cellular	AT&T Wireless	2000 14TH STREET NW	SCG	theresa.offutt@dc.gov	Samsung Rugby 3	Theresa Offutt
2024970103	Certified as Active	Wireless Phone/Device	Cellular	AT&T Wireless	414 FARRAGUT STREET NE	Snow	melony.pree@dc.gov	Sonim XP1520	Snow #27 Phone
2024970106	Certified as Active	Wireless Phone/Device	Cellular	AT&T Wireless	414 FARRAGUT STREET NE	Snow	melony.pree@dc.gov	Sonim XP1520	Snow 28 Phone
2024970134	Certified as Active	Wireless Phone/Device	Cellular	AT&T Wireless	2000 14TH STREET NW	SCG	India.Nicks@dc.gov	Samsung Rugby Pro	India Nicks
2024970177	Certified as Active	Wireless Phone/Device	Cellular	AT&T Wireless	2000 14TH STREET NW	TCO	neuris.perez@dc.gov	Samsung Rugby 3	Neuris Perez
2024970178	Certified as Active	Wireless Phone/Device	Cellular	AT&T Wireless	55 M STREET SE	TOA	Jack.herriot2@dc.gov	Note 4	JACK HERRIOT
2024970555	Certified as Active	Wireless Phone/Device	Cellular	AT&T Wireless	55 M STREET SE	TOA	Connie.Wheeler@dc.gov	Samsung Rugby Pro	Connie Wheeler
2024971800	Certified as Active	Wireless Phone/Device	Cellular	AT&T Wireless	55 M STREET SE	IPMA	mohamed.dahir@dc.gov	Samsung Rugby Pro	Mohamed Dahir
2024973517	Certified as Active	Wireless Phone/Device	Cellular	AT&T Wireless	2000 14TH STREET NW	TOA-ITS	robert.waller@dc.gov	Samsung S5	ROBERT WALLER
2024973555	Certified as Active	Wireless Phone/Device	Cellular	AT&T Wireless	2000 14TH STREET NW	SCG	crossing_guard@dc.gov	Samsung Rugby 3	Joshua Corderro
2024973834	Certified as Active	Wireless Phone/Device	Cellular	AT&T Wireless	55 M STREET SE	OD	emile.smith@dc.gov	Samsung Rugby Pro	Emile Smith
2024974729	Certified as Active	Wireless Phone/Device	Cellular	AT&T Wireless	55 M STREET SE	IPMA	Jessica.bembry@dc.gov	Samsung Galaxy S5	Jessica Bembry

Phone Number	STATUS	FUNCTION	SERVICE TYPE	VENDOR	SERVICE ADDRESS	ROOM	CONTACT	MODEL_NAME	CONTACT_NAME
2024974776	Certified as Active	Wireless Phone/Device	Cellular	AT&T Wireless	55 M STREET SE	PPSA	delois.fields@dc.gov	Samsung Rugby Pro	Deloris Fields
2024974928	Certified as Active	Wireless Phone/Device	Cellular	AT&T Wireless	1338 G STREET SE	Facilities	hubert.johnson@dc.gov	Samsung Rugby Pro	Hubert Johnson
2024974931	Certified as Active	Wireless Phone/Device	Cellular	AT&T Wireless	55 M STREET SE	HR	Sharon.Patterson@dc.gov	Samsung Rugby Pro	Sharon Patterson
2024975062	Certified as Active	Wireless Phone/Device	Cellular	AT&T Wireless	1338 G STREET SE	FOD	Calvin.lowe@dc.gov	Samsung Rugby Pro	Calvin Lowe
2024975092	Certified as Active	Wireless Phone/Device	Cellular	AT&T Wireless	55 M STREET SE	Integrity	glenda.payne@dc.gov	Samsung Rugby Pro	Glenda Payne
2024978046	Certified as Active	Wireless Phone/Device	Cellular	AT&T Wireless	2000 14TH STREET NW	SCG	gregory.harrod@dc.gov	Samsung Rugby 3	Gregory Harrod
2024978127	Certified as Active	Wireless Phone/Device	Cellular	AT&T Wireless	1403 W STREET NE	SBM	joseph.parker@dc.gov	Samsung S5	joseph parker
2024978213	Certified as Active	Wireless Phone/Device	Cellular	AT&T Wireless	2000 14TH STREET NW	TCO	George.Kollie@dc.gov	Sonim Bolt SL	George Kollie
2024978278	Certified as Active	Wireless Phone/Device	Cellular	AT&T Wireless	1403 W STREET NE	TOA	Robert.Hazel@dc.gov	Samsung S5	Robert Hazel
2024978287	Certified as Active	Wireless Phone/Device	Cellular	AT&T Wireless	1735 15TH STREET NE	Warehouse	dana.murphy@dc.gov	Samsung S5	dana murphy
2024978463	Certified as Active	Wireless Phone/Device	Cellular	AT&T Wireless	414 FARRAGUT STREET NE	SBM	Steven.jones@dc.gov	Samsung Rugby 3	Steven Jones
2024978524	Certified as Active	Wireless Phone/Device	Cellular	AT&T Wireless	2000 14TH STREET NW	SCG	brendella.greely@dc.gov	Samsung Rugby 3	Brendella Greely
2024978569	Certified as Active	Wireless Phone/Device	Cellular	AT&T Wireless	55 M STREET SE	PSOP	Nathaniel.turner@dc.gov	Samsung Rugby Pro	Nathaniel Turner
2025204404	Certified as Active	Wireless Phone/Device	Cellular	AT&T Wireless	2000 14TH STREET NW	SCG	pamela.wright-hodo@dc.gov	Samsung Rugby 3	Pamela Wright-Hodo
2025498518	Certified as Active	Wireless Phone/Device	Cellular	AT&T Wireless	55 M STREET SE	Circulator Prog	jose.colon@dc.gov	Nokia Lumia 1520	Circulator Program
2025508937	Certified as Active	Wireless Phone/Device	Cellular	AT&T Wireless	55 M STREET SE	DDOT	Raka.Choudhury@dc.gov	Samsung Galaxy s5 Active	Raka Choudhury
2025529324	Certified as Active	Wireless Phone/Device	Cellular	AT&T Wireless	2000 14TH STREET NW	TCO	Kameshia.Butler@dc.gov	Note 4	Kameshia Butler
2025538372	Certified as Active	Wireless Phone/Device	Cellular	AT&T Wireless	55 M STREET SE	GC	sandra.henderson@dc.gov	iphone 6	Sandra Henderson
2025679916	Certified as Active	Wireless Phone/Device	Cellular	AT&T Wireless	1403 W STREET	ROP	sigbee.riley@dc.gov	Samsung Rugby 3	sigbee riley
2025679995	Certified as Active	Wireless Phone/Device	Cellular	AT&T Wireless	55 M STREET SE	HR	leon.anderson@dc.gov	Samsung Galaxy S5	leon anderson
2026076533	Certified as Active	Wireless Phone/Device	Cellular	AT&T Wireless	1100 4TH STREET SW	PSRA	Jennifer.hall@dc.gov	Samsung Rugby 3	jennifer hall
2026152140	Certified as Active	Wireless Phone/Device	Cellular	AT&T Wireless	55 M STREET SE	TOA	Rodney.Foxworth@dc.gov	Samsung S5	Rodney Foxworth
2026154313	Certified as Active	Wireless Phone/Device	Cellular	AT&T Wireless	2000 14TH STREET NW	TCO	derrick.jones@dc.gov	Note 4	Derrick Jones
2026154574	Certified as Active	Wireless Phone/Device	Cellular	AT&T Wireless	55 M STREET SE	PTSA	Jameshia.Peterson@dc.gov	Samsung Galaxy s5 Active	Jameshia Peterson
2026642776	Certified as Active	Wireless Phone/Device	Cellular	AT&T Wireless	55 M STREET SE	OITI	marlene.dixon@dc.gov	Note 4	New Number
2026741323	Certified as Active	Wireless Phone/Device	Cellular	AT&T Wireless	414 FARRAGUT STREET NE	Snow	melony.pree@dc.gov	Sonim XP1520	Snow #29 Phone
2026746130	Certified as Active	Wireless Phone/Device	Cellular	AT&T Wireless	2000 14TH STREET NW	TCO	marvaughn.wheatley@dc.gov	Note 4	MarVaughan Wheatley
2026749812	Certified as Active	Wireless Phone/Device	Cellular	AT&T Wireless	55 M STREET SE	DDOT	Dawnetta.Bell@dc.gov	Note 4	Dawnetta Bell
2026767862	Certified as Active	Wireless Phone/Device	Cellular	AT&T Wireless	55 M STREET SE	OITI	tasharn.richardson@dc.gov	Samsung Galaxy s5 Active	Tasharn Richardson
2026794366	Certified as Active	Wireless Phone/Device	Cellular	AT&T Wireless	2000 14TH STREET NW	TCO	Robert.Hoyle@dc.gov	Note 4	Robert Hoyle
2026794574	Certified as Active	Wireless Phone/Device	Cellular	AT&T Wireless	2000 14TH STREET NW	TCO	gregory.hill@dc.gov	Note 4	Gregory Hill
2026794590	Certified as Active	Wireless Phone/Device	Cellular	AT&T Wireless	55 M STREET SE	LEAP	william.moyler@dc.gov	Samsung Galaxy S5	William Moyler
2026794735	Certified as Active	Wireless Phone/Device	Cellular	AT&T Wireless	55 M STREET SE	LEAP	tijuan.galloway@dc.gov	Samsung S5	Tijuan Galloway
2026897145	Certified as Active	Wireless Phone/Device	Cellular	AT&T Wireless	55 M STREET SE	LEAP	ayesha.mcnair@dc.gov	Samsung Galaxy S5	Ayesha Mcnair
2027143016	Certified as Active	Wireless Phone/Device	Cellular	AT&T Wireless	55 M STREET SE	Circulator Prog	jose.colon@dc.gov	Nokia Lumia 1520	Circulator Program
2027143093	Certified as Active	Wireless Phone/Device	Cellular	AT&T Wireless	55 M STREET SE	OITI	Danilo.Nunez@dc.gov	Nokia Lumia 1520	Danilo Nunez
2027143138	Certified as Active	Wireless Phone/Device	Cellular	AT&T Wireless	55 M STREET SE	Circulator Prog	jose.colon@dc.gov	Nokia Lumia 1520	Circulator Program
2027143156	Certified as Active	Wireless Phone/Device	Cellular	AT&T Wireless	55 M STREET SE	Circulator Prog	jose.colon@dc.gov	Nokia Lumia 1520	Circuloar Program
2027143198	Certified as Active	Wireless Phone/Device	Cellular	AT&T Wireless	414 FARRAGUT STREET NE	OITI	melony.pree@dc.gov	Sonim XP1520	Snow #12 Phone
2027143449	Certified as Active	Wireless Phone/Device	Cellular	AT&T Wireless	55 M STREET SE	HR	Deborah.Williams9@dc.gov	Samsung Galaxy s5 Active	Deborah Williams
2027143563	Certified as Active	Wireless Phone/Device	Cellular	AT&T Wireless	55 M STREET SE	LEAP	tanya.nesbit@dc.gov	Samsung Galaxy S5	Tanya Nesbit
2027143670	Certified as Active	Wireless Phone/Device	Cellular	AT&T Wireless	55 M STREET SE	Circulator Prog	jose.colon@dc.gov	Nokia Lumia 1520	Circulator Program
2027143678	Certified as Active	Wireless Phone/Device	Cellular	AT&T Wireless	55 M STREET SE	OITI	jonathan.rogers@dc.gov	Samsung Rugby Pro	Jonathan Rogers
2027143862	Certified as Active	Wireless Phone/Device	Cellular	AT&T Wireless	55 M STREET SE	LEAP	Candas.Taylor@dc.gov	Samsung Galaxy S5	Candance Taylor
2027143863	Certified as Active	Wireless Phone/Device	Cellular	AT&T Wireless	414 FARRAGUT STREET NE	Snow	melony.pree@dc.gov	Sonim XP1520	Snow #30 Phone
2027143865	Certified as Active	Wireless Phone/Device	Cellular	AT&T Wireless	55 M STREET SE	OITI	Gerel.West@dc.gov	Sonim Bolt SL	Gerel West
2027143874	Certified as Active	Wireless Phone/Device	Cellular	AT&T Wireless	55 M STREET SE	OITI	Kevin.Gibbs@dc.gov	Sonim Bolt SL	Kevin Gibbs
2027143879	Certified as Active	Wireless Phone/Device	Cellular	AT&T Wireless	55 M STREET SE	Circulator Prog	jose.colon@dc.gov	Nokia Lumia 1520	Circulator Program
2027143959	Certified as Active	Wireless Phone/Device	Cellular	AT&T Wireless	55 M STREET SE	Circulator Prog	Howard.Bethea@dc.gov	Nokia Lumia 1520	Howard Bethea
2027144518	Certified as Active	Wireless Phone/Device	Cellular	AT&T Wireless	55 M STREET SE	OITI	Diyar.Bozkurt@dc.gov	Nokia Lumia 1520	Diyar Bozkurt
2027144690	Certified as Active	Wireless Phone/Device	Cellular	AT&T Wireless	2000 14TH STREET NW	SCG	Alisha.Schools@dc.gov	Sonim Bolt SL	Alisha Schools
2027146078	Certified as Active	Wireless Phone/Device	Cellular	AT&T Wireless	55 M STREET SE	OITI	Steven.Warren@dc.gov	Sonim Bolt SL	Steven Warren
2027146909	Certified as Active	Wireless Phone/Device	Cellular	AT&T Wireless	55 M STREET SE	OITI	Tarifa.Brown@dc.gov	Samsung Galaxy S5	Tarifa Brown
2027147754	Certified as Active	Wireless Phone/Device	Cellular	AT&T Wireless	55 M STREET SE	Circulator Prog	jose.colon@dc.gov	Nokia Lumia 1520	Circulator Program
2027148802	Certified as Active	Wireless Phone/Device	Cellular	AT&T Wireless	55 M STREET SE	Circulator Prog	jose.colon@dc.gov	Nokia Lumia 1520	Circulator Program
2027149197	Certified as Active	Wireless Phone/Device	Cellular	AT&T Wireless	55 M STREET SE	Circulator Prog	jose.colon@dc.gov	Nokia Lumia 1520	Circulator Program
2027149702	Certified as Active	Wireless Phone/Device	Cellular	AT&T Wireless	55 M STREET SE	Circulator Prog	jose.colon@dc.gov	Nokia Lumia 1520	Circulator Program

Phone Number	STATUS	FUNCTION	SERVICE TYPE	VENDOR	SERVICE ADDRESS	ROOM	CONTACT	MODEL_NAME	CONTACT_NAME
2027160403	Certified as Active	Wireless Phone/Device	Cellular	AT&T Wireless	414 FARRAGUT STREET NE	SNOW	melony.pree@dc.gov	Nokia Lumia 1520	Snow #31 Phone
2027160715	Certified as Active	Wireless Phone/Device	Cellular	AT&T Wireless	55 M STREET SE	OITI	kyle.scott@dc.gov	Samsung Galaxy S5	Kyle Scott
2027161531	Certified as Active	Wireless Phone/Device	Cellular	AT&T Wireless	55 M STREET SE	OITI	regina.barnes@dc.gov	iphone 6S	Regina Barnes
2027162224	Certified as Active	Wireless Phone/Device	Cellular	AT&T Wireless	414 FARRAGUT STREET NE	SNOW	melony.pree@dc.gov	Sonim XP1520	Snow #32 Phone
2027162813	Certified as Active	Wireless Phone/Device	Cellular	AT&T Wireless	55 M STREET SE	Frank Seales	glenn.dubin@dc.gov	Nokia Lumia 1520	Glenn Dubin
2027162913	Certified as Active	Wireless Phone/Device	Cellular	AT&T Wireless	55 M STREET SE	OITI	Sara.Dorsey@dc.gov	Sonim Bolt SL	Sara Dorsey
2027164102	Certified as Active	Wireless Phone/Device	Cellular	AT&T Wireless	55 M STREET SE	OITI	jason.jones@dc.gov	Samsung Galaxy S5	Jason Jones
2027164921	Certified as Active	Wireless Phone/Device	Cellular	AT&T Wireless	55 M STREET SE	Circulator Prog	jose.colon@dc.gov	Nokia Lumia 1520	Circulator Program
2027165210	Certified as Active	Wireless Phone/Device	Cellular	AT&T Wireless	55 M STREET SE	Circulator Prog	jose.colon@dc.gov	Nokia Lumia 1520	Circulator Program
2027165302	Certified as Active	Wireless Phone/Device	Cellular	AT&T Wireless	55 M STREET SE	OITI	Marie.Mornot@dc.gov	Sonim Bolt SL	Marie Mornot
2027165405	Certified as Active	Wireless Phone/Device	Cellular	AT&T Wireless	55 M STREET SE	OITI	Jamie.Wanzer@dc.gov	Samsung Galaxy S5	Jamie Wanzer
2027166209	Certified as Active	Wireless Phone/Device	Cellular	AT&T Wireless	55 M STREET SE	Circulator Prog	marlene.dixon@dc.gov	Nokia Lumia 1520	Spare Number
2027166266	Certified as Active	Wireless Phone/Device	Cellular	AT&T Wireless	55 M STREET SE	Intern	Jasmin.Kim@dc.gov	Samsung Galaxy S5	Jasmine Kim
2027166560	Certified as Active	Wireless Phone/Device	Cellular	AT&T Wireless	55 M STREET SE	Circulator Prog	jose.colon@dc.gov	Nokia Lumia 1520	Circulator Program
2027330276	Certified as Active	Wireless Phone/Device	Cellular	AT&T Wireless	55 M STREET SE	Circulator Prog	jose.colon@dc.gov	Nokia Lumia 1520	Circulator Program
2027330674	Certified as Active	Wireless Phone/Device	Cellular	AT&T Wireless	55 M STREET SE	Snow	melony.pree@dc.gov	Sonim XP1520	Snow Phone
2027337638	Certified as Active	Wireless Phone/Device	Cellular	AT&T Wireless	55 M STREET SE	OITI	Rayne.Gibson@dc.gov	Sonim Bolt SL	Rayne Gibson
2027357192	Certified as Active	Wireless Phone/Device	Cellular	AT&T Wireless	55 M STREET SE	Circulator Prog	jose.colon@dc.gov	Nokia Lumia 1520	Circulator Program
2027469243	Certified as Active	Wireless Phone/Device	Cellular	AT&T Wireless	55 M STREET SE	Circulator Prog	jose.colon@dc.gov	Nokia Lumia 1520	Circulator Program
2027469976	Certified as Active	Wireless Phone/Device	Cellular	AT&T Wireless	55 M STREET SE	Circulator Prog	jose.colon@dc.gov	Nokia Lumia 1520	Circulator Program
2027656249	Certified as Active	Wireless Phone/Device	Cellular	AT&T Wireless	55 M STREET SE	Circulator Prog	jose.colon@dc.gov	Nokia Lumia 1520	Circulator Program
2027658004	Certified as Active	Wireless Phone/Device	Cellular	AT&T Wireless	55 M STREET SE	OITI	stephen.plano@dc.gov	Samsung Galaxy s5 Active	Stephen Plano
2027658156	Certified as Active	Wireless Phone/Device	Cellular	AT&T Wireless	55 M STREET SE	OD	Khalil.Thompson@dc.gov	iphone 6S	Khalil Thompson
2027658171	Certified as Active	Wireless Phone/Device	Cellular	AT&T Wireless	414 FARRAGUT STREET NE	SBM	anthony.owens@dc.gov	Samsung Galaxy S5	Anthony Owens
2027696805	Certified as Active	Wireless Phone/Device	Cellular	AT&T Wireless	55 M STREET SE	OITI	Tionna.Adkins@dc.gov	Sonim Bolt SL	Tionna Adkins
2027698212	Certified as Active	Wireless Phone/Device	Cellular	AT&T Wireless	55 M STREET SE	OITI	marlene.dixon@dc.gov	Note 4	Spare Number
2027699418	Certified as Active	Wireless Phone/Device	Cellular	AT&T Wireless	55 M STREET SE	SCG	Jerome.Brown@dc.gov	Sonim Bolt SL	Jerome Brown
2028031524	Certified as Active	Wireless Phone/Device	Cellular	AT&T Wireless	55 M STREET SE	Circulator Prog	jose.colon@dc.gov	Nokia Lumia 1520	Circulator Program
2028031527	Certified as Active	Wireless Phone/Device	Cellular	AT&T Wireless	55 M STREET SE	Circulator Prog	jose.colon@dc.gov	Nokia Lumia 1520	Circulator Program
2028057569	Certified as Active	Wireless Phone/Device	Cellular	AT&T Wireless	55 M STREET SE	Circulator Prog	jose.colon@dc.gov	Nokia Lumia 1520	Circulator Program
2028124641	Certified as Active	Wireless Phone/Device	Cellular	AT&T Wireless	55 M STREET SE	Circulator Prog	jose.colon@dc.gov	Nokia Lumia 1520	Circulator Program
2028124672	Certified as Active	Wireless Phone/Device	Cellular	AT&T Wireless	55 M STREET SE	Circulator Prog	jose.colon@dc.gov	Nokia Lumia 1520	Circulator Program
2028124703	Certified as Active	Wireless Phone/Device	Cellular	AT&T Wireless	55 M STREET SE	Circulator Prog	jose.colon@dc.gov	Nokia Lumia 1520	Circulator Program
2028124708	Certified as Active	Wireless Phone/Device	Cellular	AT&T Wireless	55 M STREET SE	Circulator Prog	jose.colon@dc.gov	Nokia Lumia 1520	Circulator Program
2028125180	Certified as Active	Wireless Phone/Device	Cellular	AT&T Wireless	55 M STREET SE	Circulator Prog	jose.colon@dc.gov	Nokia Lumia 1520	Circulator Program
2029038823	Certified as Active	Wireless Phone/Device	Cellular	AT&T Wireless	1338 G STREET SE	Signal	Rodney.Hart2@dc.gov	Samsung Rugby 3	Rodney Hart
2029038949	Certified as Active	Wireless Phone/Device	Cellular	AT&T Wireless	55 M STREET SE	IPMA	Sherri.Banks@dc.gov	Samsung Rugby 3	Sherri Banks
2029041281	Certified as Active	Wireless Phone/Device	Cellular	AT&T Wireless	2000 14TH STREET NW	SCG	Billy.Griffin@dc.gov	Samsung Rugby 3	Billy Griffin
2029043583	Certified as Active	Wireless Phone/Device	Cellular	AT&T Wireless	2000 14TH STREET NW	Crossing Guards	erroll.horne@dc.gov	Sonim Bolt SL	Erroll Horne
2029043725	Certified as Active	Wireless Phone/Device	Cellular	AT&T Wireless	2000 14TH STREET NW	SCG	danielle.hall@dc.gov	Samsung Rugby 3	Danielle Hall
2029043849	Certified as Active	Wireless Phone/Device	Cellular	AT&T Wireless	55 M STREET SE	PSRA	shavone.lattimore-dunn@dc.gov	Samsung Rugby Pro	Shavone Lattimore-Dunn
2029043863	Certified as Active	Wireless Phone/Device	Cellular	AT&T Wireless	55 M STREET SE	IPMA	Meredith.Upchurch@dc.gov	Samsung Rugby Pro	Meredith Upchurch
2029043865	Certified as Active	Wireless Phone/Device	Cellular	AT&T Wireless	55 M STREET SE	TOA	Chewin.Baga@dc.gov	Samsung Rugby Pro	Chewin Baga
2029043871	Certified as Active	Wireless Phone/Device	Cellular	AT&T Wireless	1403 W STREET NE	SBM	Victor.Modenessi@dc.gov	Samsung S5	Victor Modenessi
2029043884	Certified as Active	Wireless Phone/Device	Cellular	AT&T Wireless	2000 14TH STREET NW	TOA/TCO	Michael.Wise@dc.gov	Note 4	Michael Wise Michael Wise
2029043993	Certified as Active	Wireless Phone/Device	Cellular	AT&T Wireless	2000 14TH STREET NW	SCG	maurice.gatling@dc.gov	Samsung Rugby 3	Maurice Gatling
2029046901	Certified as Active	Wireless Phone/Device	Cellular	AT&T Wireless	55 M STREET SE	TCO	Delonte.Claggett@dc.gov	Note 4	Delonte Claggett
2029047377	Certified as Active	Wireless Phone/Device	Cellular	AT&T Wireless	55 M STREET SE	OITI	manyi.manga@dc.gov	Samsung S5	Eta-Manyi Manga
2029047407	Certified as Active	Wireless Phone/Device	Cellular	AT&T Wireless	2000 14TH STREET NW	TCO	andre.owens3@dc.gov	Samsung Rugby 3	Andre Owens
2029047422	Certified as Active	Wireless Phone/Device	Cellular	AT&T Wireless	2000 14TH STREET NW	SCG	anthony.mattox@dc.gov	Samsung Rugby 3	Anthony Mattox
2029047467	Certified as Active	Wireless Phone/Device	Cellular	AT&T Wireless	55 M STREET SE	SCG	marlene.dixon@dc.gov	Samsung Rugby 3	Spare Number
2029051096	Certified as Active	Wireless Phone/Device	Cellular	AT&T Wireless	55 M STREET SE	TOA	damon.johnson@dc.gov	Samsung Galaxy S5	Damon Johnson
2029051152	Certified as Active	Wireless Phone/Device	Cellular	AT&T Wireless	55 M STREET SE	OITI	george.hill@dc.gov	Samsung Rugby 3	George Hill
2029051508	Certified as Active	Wireless Phone/Device	Cellular	AT&T Wireless	2000 14TH STREET NW	TCO	Ramona.Boardley@dc.gov	Note 4	Ramona Boardley
2029051610	Certified as Active	Wireless Phone/Device	Cellular	AT&T Wireless	2000 14TH STREET NW	SCG	crossing.guard@dc.gov	Samsung Rugby 3	Kevin Steve
2029051866	Certified as Active	Wireless Phone/Device	Cellular	AT&T Wireless	55 M STREET SE	IPMA	richard.kenney@dc.gov	Samsung S5	Richard Kenney
2029053484	Certified as Active	Wireless Phone/Device	Cellular	AT&T Wireless	2000 14TH STREET NW	SCG	barbara.crosby@dc.gov	Samsung Rugby 3	Barbara Crosby

Phone Number	STATUS	FUNCTION	SERVICE TYPE	VENDOR	SERVICE ADDRESS	ROOM	CONTACT	MODEL_NAME	CONTACT_NAME
2029053548	Certified as Active	Wireless Phone/Device	Cellular	AT&T Wireless	2000 14TH STREET NW	SCG	tynia.butler@dc.gov	Samsung Rugby 3	Tynia Butler
2029053685	Certified as Active	Wireless Phone/Device	Cellular	AT&T Wireless	2000 14TH STREET NW	TOA/TCO	kenita.morgan@dc.gov	Samsung Rugby 3	kenita morgan
2029054325	Certified as Active	Wireless Phone/Device	Cellular	AT&T Wireless	2000 14TH STREET NW	TCO/SCG	Marion.Johnson@dc.gov	Sonim Bolt SL	marion johnson
2029054503	Certified as Active	Wireless Phone/Device	Cellular	AT&T Wireless	2000 14TH STREET NW	TCO	roman.williams@dc.gov	Samsung Rugby 3	Roman Williams
2029054556	Certified as Active	Wireless Phone/Device	Cellular	AT&T Wireless	2000 14TH STREET NW	TCO	Rayshawn.ford@dc.gov	Note 4	Rayshawn Ford
2029054569	Certified as Active	Wireless Phone/Device	Cellular	AT&T Wireless	2000 14TH STREET NW	SCG	pamela.johnson@dc.gov	Samsung Rugby 3	Pamela Johnson
2029054731	Certified as Active	Wireless Phone/Device	Cellular	AT&T Wireless	2000 14TH STREET NW	TCO	traffic.control@dc.gov	Samsung Rugby 3	Ikea Hudson
2029056059	Certified as Active	Wireless Phone/Device	Cellular	AT&T Wireless	1338 G STREET SE	1st Floor	randolph.cooper@dc.gov	Samsung Rugby Pro	randolph cooper
2029056203	Certified as Active	Wireless Phone/Device	Cellular	AT&T Wireless	55 M STREET SE	OITI	Samantha.Muschette@d c.gov	Samsung Rugby 3	Samantha Mushette
2029056767	Certified as Active	Wireless Phone/Device	Cellular	AT&T Wireless	2000 14TH STREET NW	Rope	darren.warren@dc.gov	Samsung Rugby 3	Darren Warren
2029057385	Certified as Active	Wireless Phone/Device	Cellular	AT&T Wireless	2000 14TH STREET NW	SCG	diane.robinson@dc.gov	Samsung Rugby 3	Diane Robinson
2029058993	Certified as Active	Wireless Phone/Device	Cellular	AT&T Wireless	2000 14TH STREET NW	SCG	lolita.morgan@dc.gov	Samsung Rugby 3	Lolita Morgan
2029059574	Certified as Active	Wireless Phone/Device	Cellular	AT&T Wireless	2000 14TH STREET NW	SCG	patricia.morton@dc.gov	Samsung Rugby 3	Patricia Morton
2029077107	Certified as Active	Wireless Phone/Device	Cellular	AT&T Wireless	2000 14TH STREET NW	SCG	crossing.guard@dc.gov	Samsung Rugby 3	Monique Mobley
2029077270	Certified as Active	Wireless Phone/Device	Cellular	AT&T Wireless	55 M STREET SE	IPMA	Vrushali.Tickle@dc.gov	Samsung S5	Vrushali Tickle
2029079362	Certified as Active	Wireless Phone/Device	Cellular	AT&T Wireless	414 FARRAGUT STREET NE	Snow Phone	melony.pree@dc.gov	Sonim XP1520	Snow #6 Phone
2029079366	Certified as Active	Wireless Phone/Device	Cellular	AT&T Wireless	1338 G STREET SE	TOA-ITS	chauncey.taylor@dc.gov	Samsung Rugby Pro	Chauncey Taylor
2029079417	Certified as Active	Wireless Phone/Device	Cellular	AT&T Wireless	55 M STREET SE	UFA	jason.street@dc.gov	Samsung Rugby 3	Jason Street
2029079435	Certified as Active	Wireless Phone/Device	Cellular	AT&T Wireless	2000 14TH STREET NW	SCG	ella.smith@dc.gov	Samsung Rugby 3	Ella Smith
2029079439	Certified as Active	Wireless Phone/Device	Cellular	AT&T Wireless	2000 14TH STREET NW	TCO	devon.moon@dc.gov	Note 4	Devon Moon
2029079473	Certified as Active	Wireless Phone/Device	Cellular	AT&T Wireless	55 M STREET SE	IPMA	Kadidjatou.Ayeva@dc.gov	Samsung Rugby Pro	Kadidjatou Ayeva
2029079474	Certified as Active	Wireless Phone/Device	Cellular	AT&T Wireless	55 M STREET SE	EEO	Luisa.Nguyen@dc.gov	Samsung Rugby Pro	luisa Nuygen
2029079475	Certified as Active	Wireless Phone/Device	Cellular	AT&T Wireless	55 M STREET SE	IPMA	John.Gomes@dc.gov	Samsung Rugby Pro	John Gomes
2029079482	Certified as Active	Wireless Phone/Device	Cellular	AT&T Wireless	1338 G STREET SE	G ST SE	latasha.greenaway@dc.gov	Samsung Rugby 3	LaTasha Greenaway
2024236862	Certified as Active	Wireless Phone/Device	Cellular	AT&T Wireless	2000 14TH STREET NW	Snow Phone	Shirmeka.Hines@dc.gov	Sonim Bolt SL	Shirmeka Hines
2022074500	Certified as Active	Wireless Phone/Device	Cellular	AT&T Wireless	55 M STREET SE	OITI	marlene.dixon@dc.gov	Samsung Rugby 3	accessories Purchases
2022074606	Certified as Active	Wireless Phone/Device	Cellular	AT&T Wireless	1725 15TH STREET NE	ROPE	kevin.james@dc.gov	Samsung Rugby Pro	KEVIN JAMES
2022074660	Certified as Active	Wireless Phone/Device	Cellular	AT&T Wireless	55 M STREET SE	OITI	towanda.connor@dc.gov	Samsung Rugby 3	Towanda Connor
2022074664	Certified as Active	Wireless Phone/Device	Cellular	AT&T Wireless	55 M STREET SE	IPMA	Rahamt.Rasson@dc.gov	Samsung Rugby Pro	Rahamt Rasson
2022074970	Certified as Active	Wireless Phone/Device	Cellular	AT&T Wireless	55 M STREET SE	IPMA	Robert.Horton@dc.gov	Samsung Galaxy S5	Robert Horton
2022102289	Certified as Active	Wireless Phone/Device	Cellular	AT&T Wireless	55 M STREET SE	2nd	lanel.sartin@dc.gov	Sonim Bolt SL	NHS 1 Phone
2022104542	Certified as Active	Wireless Phone/Device	Cellular	AT&T Wireless	55 M STREET SE	IPMA	Joseph.Dorsey@dc.gov	Samsung Rugby Pro	Joseph Dorsey
2022105692	Certified as Active	Wireless Phone/Device	Cellular	AT&T Wireless	55 M STREET SE	OD	ronald.covington@dc.gov	Samsung Rugby Pro	Ronald Covington
2022105779	Certified as Active	Wireless Phone/Device	Cellular	AT&T Wireless	55 M STREET SE	OITI	baba.bamisiaye@dc.gov	Samsung Galaxy S4	Baba Bamisiaye
2022108588	Certified as Active	Wireless Phone/Device	Cellular	AT&T Wireless	55 M STREET SE	OITI	isdore.anyanwu@dc.gov	Samsung Galaxy s5 Active	Isdore Anyanwu
2023210413	Certified as Active	Wireless Phone/Device	Cellular	AT&T Wireless	2000 14TH STREET NW	SCG	helen.butler@dc.gov	Samsung Rugby 3	Helen Butler
2023452446	Certified as Active	Wireless Phone/Device	Cellular	AT&T Wireless	55 M STREET SE	TOA	Jose.wood@dc.gov	Samsung Rugby Pro	Jose Wood
2023452447	Certified as Active	Wireless Phone/Device	Cellular	AT&T Wireless	55 M STREET SE	OD	robyn.freeman@dc.gov	Samsung S5	Robyn Freeman
2023452616	Certified as Active	Wireless Phone/Device	Cellular	AT&T Wireless	1100 4TH STREET SW	PSRA	shannon.jones@dc.gov	Samsung Rugby Pro	Shannon Jones
2023452748	Certified as Active	Wireless Phone/Device	Cellular	AT&T Wireless	55 M STREET SE	IPMA	Kendrick.Miles@dc.gov	Samsung Rugby Pro	Kendrick Miles
2023452752	Certified as Active	Wireless Phone/Device	Cellular	AT&T Wireless	55 M STREET SE	IPMA	deinma.jamabo@dc.gov	Samsung Rugby Pro	Deinma Jamabo
2023452754	Certified as Active	Wireless Phone/Device	Cellular	AT&T Wireless	55 M STREET SE	IPMA	phillip.daniel@dc.gov	Samsung S5	Phillip Daniel
2023452806	Certified as Active	Wireless Phone/Device	Cellular	AT&T Wireless	1100 4TH STREET SW	PSRA	Rahsaan.French@dc.gov	Samsung Rugby Pro	Rahsaan French
2023452832	Certified as Active	Wireless Phone/Device	Cellular	AT&T Wireless	55 M STREET SE	IPMA	Maurice.Prince@dc.gov	Samsung Rugby Pro	Maurice Prince
2023452841	Certified as Active	Wireless Phone/Device	Cellular	AT&T Wireless	55 M STREET SE	IPMA	Kevin.Burns@dc.gov	Samsung Rugby Pro	Kevin Burns
2023452859	Certified as Active	Wireless Phone/Device	Cellular	AT&T Wireless	2000 14TH STREET NW	TCO	Isaiah.Daniel@dc.gov	Note 4	Isaiah Daniel
2023452910	Certified as Active	Wireless Phone/Device	Cellular	AT&T Wireless	55 M STREET SE	IPMA	Srinath.Ananth@dc.gov	Samsung S5	Srinath Ananth
2023452913	Certified as Active	Wireless Phone/Device	Cellular	AT&T Wireless	1338 G STREET SE	G ST SE	virgil.thompson@dc.gov	Samsung Rugby 3	Virgil Thompson
2023452928	Certified as Active	Wireless Phone/Device	Cellular	AT&T Wireless	55 M STREET SE	OITI	Romanus.njepu@dc.gov	Samsung Rugby Pro	Romanus Njepu
2023452929	Certified as Active	Wireless Phone/Device	Cellular	AT&T Wireless	55 M STREET SE	IPMA	William.Lester@dc.gov	Samsung Rugby Pro	William Lester
2023453700	Certified as Active	Wireless Phone/Device	Cellular	AT&T Wireless	55 M STREET SE	IPMA	rezene.medhani@dc.gov	Samsung Rugby Pro	Rezene Medhani
2023454185	Certified as Active	Wireless Phone/Device	Cellular	AT&T Wireless	55 M STREET SE	IPMA	sandeep.bhatia@dc.gov	Samsung Rugby Pro	Sandeep Bhatia
2023454328	Certified as Active	Wireless Phone/Device	Cellular	AT&T Wireless	55 M STREET SE	HR	reymonte.washington@d c.gov	Samsung Galaxy Mega	Reymonte Washington
2023454340	Certified as Active	Wireless Phone/Device	Cellular	AT&T Wireless	2000 14TH STREET NW	SCG	monroe.farewell@dc.gov	Samsung Rugby 3	Monroe Farewell
2023456636	Certified as Active	Wireless Phone/Device	Cellular	AT&T Wireless	1338 G STREET SE	TOA-ITS	shauntia.evans@dc.gov	Samsung S5	SHAUNTIA EVANS
2023456642	Certified as Active	Wireless Phone/Device	Cellular	AT&T Wireless	2000 14TH STREET NW	600N	robert.marsili@dc.gov	iphone 6	ROBERT MARSILI
2023456873	Certified as Active	Wireless Phone/Device	Cellular	AT&T Wireless	55 M STREET SE	IPMA	Yigzaw.Menberu@dc.gov	Kyocera Device	Yigzaw Menberu

Phone Number	STATUS	FUNCTION	SERVICE TYPE	VENDOR	SERVICE ADDRESS	ROOM	CONTACT	MODEL_NAME	CONTACT_NAME
2023456876	Certified as Active	Wireless Phone/Device	Cellular	AT&T Wireless	55 M STREET SE	OITI	marlene.dixon@dc.gov	Samsung Rugby Pro	Spare Number
2023457105	Certified as Active	Wireless Phone/Device	Cellular	AT&T Wireless	55 M STREET SE	IPMA	Reginald.Arno@dc.gov	Samsung Rugby Pro	Reginald Arno
2023457107	Certified as Active	Wireless Phone/Device	Cellular	AT&T Wireless	1338 G STREET SE	1st Fl	jonathan.wilson@dc.gov	Samsung Rugby Pro	Spare Tablet
2023590196	Certified as Active	Wireless Phone/Device	Cellular	AT&T Wireless	414 FARRAGUT STREET NE	Snow Phone	melony.pree@dc.gov	Sonim XP1520	Snow #5 Phone
2023590224	Certified as Active	Wireless Phone/Device	Cellular	AT&T Wireless	55 M STREET SE	TOA	Rashele.Maclin@dc.gov	Samsung Rugby Pro	Rashele Maclin
2023590227	Certified as Active	Wireless Phone/Device	Cellular	AT&T Wireless	2000 14TH STREET NW	TCO	wendell.johnson2@dc.gov	Sonim Bolt SL	Wendell Johnson
2023590560	Certified as Active	Wireless Phone/Device	Cellular	AT&T Wireless	2000 14TH STREET NW	SCG	antoinette.millard@dc.gov	Samsung Rugby 3	Antoinette Millard
2023590593	Certified as Active	Wireless Phone/Device	Cellular	AT&T Wireless	55 M STREET SE	IPMA/AVL	marlene.dixon@dc.gov	Eroad Nav A1	Seasonal Standby
2023590801	Certified as Active	Wireless Phone/Device	Cellular	AT&T Wireless	414 FARRAGUT STREET NE	Snow	melony.pree@dc.gov	Sonim XP1520	Snow Phone
2023590961	Certified as Active	Wireless Phone/Device	Cellular	AT&T Wireless	55 M STREET SE	IPMA	Aaron.Horton@dc.gov	Samsung S5	Aaron Horton
2023591369	Certified as Active	Wireless Phone/Device	Cellular	AT&T Wireless	55 M STREET SE	IPMA	kajaz.safarian@dc.gov	Samsung Galaxy S5	Kajaz Safarain
2023591478	Certified as Active	Wireless Phone/Device	Cellular	AT&T Wireless	2000 14TH STREET NW	TOA-ITS	Harvey.Alexander@dc.gov	Samsung Galaxy S5	Harvey Alexander
2023592449	Certified as Active	Wireless Phone/Device	Cellular	AT&T Wireless	55 M STREET SE	UFA	john.thomas@dc.gov	Samsung Rugby Pro	UFA Emergency Phone
2023592507	Certified as Active	Wireless Phone/Device	Cellular	AT&T Wireless	1403 W STREET	SBM	richard.rosebar@dc.gov	Samsung S5	Richard Rosebar
2023592559	Certified as Active	Wireless Phone/Device	Cellular	AT&T Wireless	55 M STREET SE	UFA	marlene.dixon@dc.gov	Samsung Rugby Pro	Under Investigaton
2023592677	Certified as Active	Wireless Phone/Device	Cellular	AT&T Wireless	55 M STREET SE	IPMA	Anthony.Dinkins@dc.gov	Samsung Galaxy S5	Anthony Dinkins
2023592682	Certified as Active	Wireless Phone/Device	Cellular	AT&T Wireless	1735 15TH STREET NE	ROPE	jeremy.wilson@dc.gov	Samsung Rugby Pro	Jeremy Wilson
2023592694	Certified as Active	Wireless Phone/Device	Cellular	AT&T Wireless	55 M STREET SE	OD	anthony.carson2@dc.gov	Samsung S5	Anthony Carson
2023592696	Certified as Active	Wireless Phone/Device	Cellular	AT&T Wireless	55 M STREET SE	TOA	Tan.Nguyen@dc.gov	Samsung Rugby Pro	Tan Nguyen
2023592707	Certified as Active	Wireless Phone/Device	Cellular	AT&T Wireless	1403 W STREET	Equipment Trail	antonio.burnette@dc.gov	Samsung Rugby Pro	Antonio Burnette
2023592726	Certified as Active	Wireless Phone/Device	Cellular	AT&T Wireless	2000 14TH STREET NW	TCO	Wayne.dennis@dc.gov	Sonim Bolt SL	Wayne Dennis
2023592751	Certified as Active	Wireless Phone/Device	Cellular	AT&T Wireless	55 M STREET SE	PSRA	raymond.mcleod@dc.gov	Samsung Rugby Pro	Raymond Mcleod
2023592890	Certified as Active	Wireless Phone/Device	Cellular	AT&T Wireless	55 M STREET SE	Workforce DEV	Iberia.miles@dc.gov	Samsung Rugby Pro	Iberia Miles
2023593005	Certified as Active	Wireless Phone/Device	Cellular	AT&T Wireless	55 M STREET SE	OD	linda.fennell@dc.gov	Samsung Rugby Pro	Linda Fennell
2023593006	Certified as Active	Wireless Phone/Device	Cellular	AT&T Wireless	55 M STREET SE	TOA	victorine.gewi@dc.gov	Samsung Rugby Pro	victorine gwei
2023593054	Certified as Active	Wireless Phone/Device	Cellular	AT&T Wireless	310 MCMILLAN DRIVE NW	QA/QC	Daniel.Kest@dc.gov	Samsung Rugby Pro	Daniel Kest
2023593550	Certified as Active	Wireless Phone/Device	Cellular	AT&T Wireless	55 M STREET SE	Safety/ TOA /DD	Mohammad.Ullah@dc.gov	Samsung Rugby Pro	Mohammad Ullah
2023593688	Certified as Active	Wireless Phone/Device	Cellular	AT&T Wireless	1735 15TH STREET NE	Rope	carlos.barksdale@dc.gov	Samsung Rugby Pro	Carlos Barksdale
2023594174	Certified as Active	Wireless Phone/Device	Cellular	AT&T Wireless	1735 15TH STREET NE	warehouse	allen.huntley@dc.gov	Samsung Rugby Pro	allen huntley
2023595463	Certified as Active	Wireless Phone/Device	Cellular	AT&T Wireless	55 M STREET SE	OCFO	Calvin.Skinner@dc.gov	Samsung Rugby Pro	Calvin Skinner
2023595857	Certified as Active	Wireless Phone/Device	Cellular	AT&T Wireless	1403 W STREET	SBM	brenda.bailey2@dc.gov	Samsung Rugby 3	Brenda Bailey
2023595860	Certified as Active	Wireless Phone/Device	Cellular	AT&T Wireless	2000 14TH STREET NW	SCG	angela.worthy@dc.gov	Samsung Rugby Pro	Angela Worthy
2023595941	Certified as Active	Wireless Phone/Device	Cellular	AT&T Wireless	55 M STREET SE	TOA	wasim.raja@dc.gov	Samsung Rugby Pro	Wasim Raja
2023596095	Certified as Active	Wireless Phone/Device	Cellular	AT&T Wireless	55 M STREET SE	5	catrina.felder@dc.gov	Samsung Rugby 3	Catrina Harrison-Felder
2023596134	Certified as Active	Wireless Phone/Device	Cellular	AT&T Wireless	2000 14TH STREET NW	SCG	otis.humphrey@dc.gov	Samsung Rugby 3	Otis Humphrey
2023596170	Certified as Active	Wireless Phone/Device	Cellular	AT&T Wireless	55 M STREET SE	IPMA	Ej.Simie@dc.gov	Samsung Rugby Pro	Ej Simie
2023596194	Certified as Active	Wireless Phone/Device	Cellular	AT&T Wireless	55 M STREET SE	IPMA	rdonnell@dc.gov	Samsung Rugby Pro	Ra'adia Donnell
2023596209	Certified as Active	Wireless Phone/Device	Cellular	AT&T Wireless	1100 4TH STREET SW	PSRA	fikru.wake@dc.gov	Samsung S5	Fikru Wake
2023596342	Certified as Active	Wireless Phone/Device	Cellular	AT&T Wireless	1403 W STREET	SBM	garrett.jackson@dc.gov	Samsung Rugby 3	Garrett Jackson
2023596409	Certified as Active	Wireless Phone/Device	Cellular	AT&T Wireless	55 M STREET SE	IPMA	Levon.Petrosian@dc.gov	Samsung Rugby Pro	Levon Petrosian
2023596573	Certified as Active	Wireless Phone/Device	Cellular	AT&T Wireless	55 M STREET SE	OITI	marlene.dixon@dc.gov	Samsung Rugby Pro	Spare Number
2023596722	Certified as Active	Wireless Phone/Device	Cellular	AT&T Wireless	55 M STREET SE	OITI	crossing.guard@dc.gov	Samsung Rugby Pro	Jamela Thompson
2023599746	Certified as Active	Wireless Phone/Device	Cellular	AT&T Wireless	55 M STREET SE	TOA	Fred.Akinbolajo@dc.gov	Samsung Galaxy S5	Fred Akinbolajo
2023599952	Certified as Active	Wireless Phone/Device	Cellular	AT&T Wireless	1338 G STREET SE	PSRA Detailed	charles.king@dc.gov	Samsung Rugby Pro	Charles King
2023690572	Certified as Active	Wireless Phone/Device	Cellular	AT&T Wireless	55 M STREET SE	IPMA	Jaswant.Matharu@dc.gov	Samsung S5	Jaswant Matharu
2023690662	Certified as Active	Wireless Phone/Device	Cellular	AT&T Wireless	2000 14TH STREET NW	SCG	machelle.gantt@dc.gov	Samsung Rugby 3	Machelle Gant
2023691921	Certified as Active	Wireless Phone/Device	Cellular	AT&T Wireless	2000 14TH STREET NW	SCG	angela.jenkins@dc.gov	Samsung Rugby Pro	Angela Jenkins
2023692084	Certified as Active	Wireless Phone/Device	Cellular	AT&T Wireless	55 M STREET SE	OD	natalie.jonesbest@dc.gov	Samsung Galaxy S5	Natalie Jones-Best
2023692383	Certified as Active	Wireless Phone/Device	Cellular	AT&T Wireless	55 M STREET SE	DDOT	Alice.Kelly@dc.gov	Samsung Rugby 3	Alice Kelly
2023692541	Certified as Active	Wireless Phone/Device	Cellular	AT&T Wireless	55 M STREET SE	IPMA	Stanley.Freeman@dc.gov	Samsung S5	Stanley Freeman
2023692580	Certified as Active	Wireless Phone/Device	Cellular	AT&T Wireless	55 M STREET SE	PSRA	andre.powell2@dc.gov	Samsung Rugby Pro	Andre Powell
2023693721	Certified as Active	Wireless Phone/Device	Cellular	AT&T Wireless	55 M STREET SE	TOA	Jama.Abdil@dc.gov	Samsung Rugby Pro	Jama Abdil
2023694637	Certified as Active	Wireless Phone/Device	Cellular	AT&T Wireless	55 M STREET SE	OD	Portia.Perkins@dc.gov	Kyocera Device	Portia Perkins
2023694688	Certified as Active	Wireless Phone/Device	Cellular	AT&T Wireless	2000 14TH STREET NW	TCO	Roland.Tyler@dc.gov	Sonim Bolt SL	Roland Tyler
2023695543	Certified as Active	Wireless Phone/Device	Cellular	AT&T Wireless	55 M STREET SE	PSRA	robert.lee@dc.gov	Samsung Rugby Pro	Robert Lee
2023695635	Certified as Active	Wireless Phone/Device	Cellular	AT&T Wireless	2000 14TH STREET NW	SCG	cassandra.smallwood@dc.gov	Samsung Rugby 3	Cassandra Smallwood
2023695808	Certified as Active	Wireless Phone/Device	Cellular	AT&T Wireless	55 M STREET SE	IPMA	elijah.robinson@dc.gov	Samsung Rugby Pro	Elijah Robinson

Phone Number	STATUS	FUNCTION	SERVICE TYPE	VENDOR	SERVICE ADDRESS	ROOM	CONTACT	MODEL_NAME	CONTACT_NAME
2023695870	Certified as Active	Wireless Phone/Device	Cellular	AT&T Wireless	2000 14TH STREET NW	TOA	Lavelle.gaston@dc.gov	Samsung Rugby Pro	Lavelle Gaston
2023697048	Certified as Active	Wireless Phone/Device	Cellular	AT&T Wireless	55 M STREET SE	PTSA	joann.lowe@dc.gov	Samsung Rugby Pro	Joann Lowe
2023697483	Certified as Active	Wireless Phone/Device	Cellular	AT&T Wireless	55 M STREET SE	TOA	Ogechi.Elekwachi@dc.gov	Samsung Galaxy S4	Ogechi Elekwachi
2023697581	Certified as Active	Wireless Phone/Device	Cellular	AT&T Wireless	2000 14TH STREET NW	TOA	Norman.Siler@dc.gov	Samsung Rugby 3	Norman Siler
2023697599	Certified as Active	Wireless Phone/Device	Cellular	AT&T Wireless	1338 G STREET SE	1338 G ST	james.berry@dc.gov	Samsung Rugby Pro	James Berry
2023697619	Certified as Active	Wireless Phone/Device	Cellular	AT&T Wireless	1338 G STREET SE	TOA	dion.james@dc.gov	Samsung S5	Dion James
2023697691	Certified as Active	Wireless Phone/Device	Cellular	AT&T Wireless	1338 G STREET SE	Sign Shop	david.waaldijk@dc.gov	Samsung Rugby Pro	David Waaldijk
2023697707	Certified as Active	Wireless Phone/Device	Cellular	AT&T Wireless	55 M STREET SE	IPMA	Charles.Krestsi@dc.gov	Samsung Rugby Pro	Charles Krestsi
2023697727	Certified as Active	Wireless Phone/Device	Cellular	AT&T Wireless	414 FARRAGUT STREET NE	SBM	justin.robinson@dc.gov	Samsung Galaxy s5 Active	Justin Robinson
2023697733	Certified as Active	Wireless Phone/Device	Cellular	AT&T Wireless	280 MCMILLAN DRIVE NW	DDOT, IPMA-QA/Q	Patrick.Ledda@dc.gov	Samsung Rugby 3	Patrick Ledda
2023697775	Certified as Active	Wireless Phone/Device	Cellular	AT&T Wireless	2000 14TH STREET NW	TMC	marlene.dixon@dc.gov	Sonim Bolt SL	Seasonal Standby
2023697824	Certified as Active	Wireless Phone/Device	Cellular	AT&T Wireless	55 M STREET SE	UFA	nathan.campbell@dc.gov	Samsung S5	Nathan Campbell
2023697845	Certified as Active	Wireless Phone/Device	Cellular	AT&T Wireless	55 M STREET SE	PPSA	mark.rawlings@dc.gov	Samsung Rugby 3	Mark Rawlings
2023697911	Certified as Active	Wireless Phone/Device	Cellular	AT&T Wireless	1403 W STREET	SBM	eric.claggett@dc.gov	Samsung Galaxy S5	Eric Claggett
2023697915	Certified as Active	Wireless Phone/Device	Cellular	AT&T Wireless	2000 14TH STREET NW	TCO	Deidre.McCane@dc.gov	Note 4	Deidre McCane
2023697917	Certified as Active	Wireless Phone/Device	Cellular	AT&T Wireless	55 M STREET SE	IPMA	Bruke.Siraga@dc.gov	Samsung Rugby Pro	Bruke Siraga
2023697921	Certified as Active	Wireless Phone/Device	Cellular	AT&T Wireless	55 M STREET SE	PSRA	robert.white2@dc.gov	Samsung Rugby Pro	Robert White
2023697923	Certified as Active	Wireless Phone/Device	Cellular	AT&T Wireless	1338 G STREET SE	SignFabrication	harold.thomas@dc.gov	Samsung Rugby Pro	Harold Thomas
2023697925	Certified as Active	Wireless Phone/Device	Cellular	AT&T Wireless	55 M STREET SE	OITI	karl.baynes@dc.gov	Samsung S5	Karl Baynes
2023697929	Certified as Active	Wireless Phone/Device	Cellular	AT&T Wireless	55 M STREET SE	PSOD	Stacey.collins@dc.gov	Nokia Lumia 1520	Stacey Collins
2023697938	Certified as Active	Wireless Phone/Device	Cellular	AT&T Wireless	1338 G STREET SE	1338 G ST SE	phyllis1.jakes@dc.gov	Samsung Rugby 3	Phyllis Jakes
2023698580	Certified as Active	Wireless Phone/Device	Cellular	AT&T Wireless	55 M STREET SE	OD	vanessa.winfield@dc.gov	Samsung Rugby Pro	VANESSA WINFIELD
2023698666	Certified as Active	Wireless Phone/Device	Cellular	AT&T Wireless	1403 W STREET NE	SBM	Jose.Silva@dc.gov	Samsung S5	Jose Silva
2023699021	Certified as Active	Wireless Phone/Device	Cellular	AT&T Wireless	55 M STREET SE	IMPA	Theresa.washington@dc.gov	Samsung Rugby Pro	Theresa Washington
2023699387	Certified as Active	Wireless Phone/Device	Cellular	AT&T Wireless	55 M STREET SE	n/a	mohamud.hassan@dc.gov	Samsung Rugby Pro	Mohamud Hassan
2023699401	Certified as Active	Wireless Phone/Device	Cellular	AT&T Wireless	2000 14TH STREET NW	TOA	jermont.graves@dc.gov	Samsung Rugby 3	jermont graves
2023699818	Certified as Active	Wireless Phone/Device	Cellular	AT&T Wireless	55 M STREET SE	IPMA	Mark.Clabaugh@dc.gov	Samsung Rugby Pro	Mark Clabaugh
2023699851	Certified as Active	Wireless Phone/Device	Cellular	AT&T Wireless	55 M STREET SE	PSRA	victor.nwabueze@dc.gov	Samsung Rugby Pro	Victor Nwabueze
2023738435	Certified as Active	Wireless Phone/Device	Cellular	AT&T Wireless	2000 14TH STREET NW	SCG	kenny.dudley@dc.gov	Samsung Rugby 3	Kenny Dudley
2023738440	Certified as Active	Wireless Phone/Device	Cellular	AT&T Wireless	1100 4TH STREET SW	PSRA	quartney.douggett@dc.gov	Samsung Rugby Pro	Quartney Doggett
2023738442	Certified as Active	Wireless Phone/Device	Cellular	AT&T Wireless	2000 14TH STREET NW	SCG	Merial.Jones@dc.gov	Sonim Bolt SL	Merial Jones
2023738443	Certified as Active	Wireless Phone/Device	Cellular	AT&T Wireless	2000 14TH STREET NW	SCG	crossing.guard@dc.gov	Samsung Rugby 3	Robert Edwards
2023738446	Certified as Active	Wireless Phone/Device	Cellular	AT&T Wireless	2000 14TH STREET NW	SCG	lortrice.watkins@dc.gov	Note 4	Lortrice Watkins
2023738447	Certified as Active	Wireless Phone/Device	Cellular	AT&T Wireless	2000 14TH STREET NW	SCG	milton.blount@dc.gov	Samsung Rugby 3	Milton Blount
2023738448	Certified as Active	Wireless Phone/Device	Cellular	AT&T Wireless	55 M STREET SE	PTSA	Anthony.Foster@dc.gov	Samsung Rugby Pro	Anthony Foster
2023738453	Certified as Active	Wireless Phone/Device	Cellular	AT&T Wireless	55 M STREET SE	Spare	Sharlene.White@dc.gov	Sonim Bolt SL	Sharlene White
2023738454	Certified as Active	Wireless Phone/Device	Cellular	AT&T Wireless	55 M STREET SE	OITI	Shawntice.Jones@dc.gov	Sonim Bolt SL	Shawntice Jones
2023738457	Certified as Active	Wireless Phone/Device	Cellular	AT&T Wireless	55 M STREET SE	OITI	Jonathan.wilson@dc.gov	iPhone 5	Jonathan Wilson
2023738458	Certified as Active	Wireless Phone/Device	Cellular	AT&T Wireless	2000 14TH STREET NW	SCG	crossing.guard@dc.gov	Samsung Rugby Pro	Marquette Williams
2023738461	Certified as Active	Wireless Phone/Device	Cellular	AT&T Wireless	55 M STREET SE	OITI	Robert.Grimes@dc.gov	Samsung Rugby Pro	Robert Grimes
2023738463	Certified as Active	Wireless Phone/Device	Cellular	AT&T Wireless	2000 14TH STREET NW	SCG	candace.deal@dc.gov	Sonim Bolt SL	Candace Deal
2023738465	Certified as Active	Wireless Phone/Device	Cellular	AT&T Wireless	2000 14TH STREET NW	TOA/TCO	darnell.tillman@dc.gov	Samsung Rugby 3	Darnell Tillman
2023738469	Certified as Active	Wireless Phone/Device	Cellular	AT&T Wireless	55 M STREET SE	TOA	antoine.lewis@dc.gov	Samsung S5	Antoine Lewis
2023738471	Certified as Active	Wireless Phone/Device	Cellular	AT&T Wireless	2000 14TH STREET NW	TOA/SCG	crossing.guard@dc.gov	Samsung Rugby 3	Ricayya Davis
2023738475	Certified as Active	Wireless Phone/Device	Cellular	AT&T Wireless	55 M STREET SE	OITI	Rumon.toatley@dc.gov	Samsung Rugby 3	Rumon Toatley
2023738485	Certified as Active	Wireless Phone/Device	Cellular	AT&T Wireless	1725 15TH STREET NE	Rope	eric.shannon@dc.gov	Samsung Rugby Pro	Eric Shannon
2023738486	Certified as Active	Wireless Phone/Device	Cellular	AT&T Wireless	55 M STREET SE	IPMA	monique.nichols@dc.gov	Samsung Rugby Pro	Monique Nichols
2023738487	Certified as Active	Wireless Phone/Device	Cellular	AT&T Wireless	2000 14TH STREET NW	TCO	bradley.murchison@dc.gov	Samsung Rugby Pro	Bradley Murchinson
2023738489	Certified as Active	Wireless Phone/Device	Cellular	AT&T Wireless	2000 14TH STREET NW	TCO	Lorenzo.pugh@dc.gov	Samsung Rugby Pro	lorenzo pugh
2023738492	Certified as Active	Wireless Phone/Device	Cellular	AT&T Wireless	2000 14TH STREET NW	TOA/TCO	Jason.Godfrey@dc.gov	iPhone 4s	Jason Godfrey
2023738495	Certified as Active	Wireless Phone/Device	Cellular	AT&T Wireless	55 M STREET SE	Civil Rights	Leutisha.Stills@dc.gov	Samsung Rugby Pro	Leutisha Stills
2023738496	Certified as Active	Wireless Phone/Device	Cellular	AT&T Wireless	1403 W STREET NE	SBM	marlene.dixon@dc.gov	Samsung Rugby 3	Seasonal Standby
2023865214	Certified as Active	Wireless Phone/Device	Cellular	AT&T Wireless	414 FARRAGUT STREET NE	SBM	Anitra.weems@dc.gov	Samsung Rugby 3	Anitra Weems
2023865225	Certified as Active	Wireless Phone/Device	Cellular	AT&T Wireless	2000 14TH STREET NW	TOA-ITS	Clark.Browder@dc.gov	Samsung Rugby Pro	Clark Browder
2023865400	Certified as Active	Wireless Phone/Device	Cellular	AT&T Wireless	414 FARRAGUT STREET NE	SBM	Tritty.Jones@dc.gov	Samsung S5	Tritty Ross
2023865401	Certified as Active	Wireless Phone/Device	Cellular	AT&T Wireless	1338 G STREET SE	Sign Fabricatio	Mohammad.Wahab@dc.gov	Samsung Rugby 3	Mohammad Wahab
2023865808	Certified as Active	Wireless Phone/Device	Cellular	AT&T Wireless	1403 W STREET	SBM	daniel.ellis@dc.gov	Samsung Rugby Pro	Daniel Ellis

Phone Number	STATUS	FUNCTION	SERVICE TYPE	VENDOR	SERVICE ADDRESS	ROOM	CONTACT	MODEL_NAME	CONTACT_NAME
202391270	Certified as Active	Wireless Phone/Device	Cellular	AT&T Wireless	2000 14TH STREET NW	TCO	Nettina.wren@dc.gov	Samsung Rugby Pro	nettina wren
202391271	Certified as Active	Wireless Phone/Device	Cellular	AT&T Wireless	55 M STREET SE	SIOD	james.henry@dc.gov	Samsung Rugby Pro	James Henry
202391273	Certified as Active	Wireless Phone/Device	Cellular	AT&T Wireless	1403 W STREET	SBM	julius.taylor@dc.gov	Samsung Rugby 3	Julius Taylor
202391274	Certified as Active	Wireless Phone/Device	Cellular	AT&T Wireless	55 M STREET SE	IPMA	Modibo.Hyton@dc.gov	Samsung S5	Modibo Hyton
2023918191	Certified as Active	Wireless Phone/Device	Cellular	AT&T Wireless	55 M STREET SE	TOA	Teresita.Harper@dc.gov	Samsung Rugby Pro	Teresita Harper
2023918192	Certified as Active	Wireless Phone/Device	Cellular	AT&T Wireless	55 M STREET SE	IPMA	Amal.Azzam@dc.gov	Samsung Rugby Pro	Amal Azzam
2023918193	Certified as Active	Wireless Phone/Device	Cellular	AT&T Wireless	55 M STREET SE	IPMA	Zahra.Dorriz@dc.gov	Samsung Rugby Pro	Zahra Dorriz
2023918195	Certified as Active	Wireless Phone/Device	Cellular	AT&T Wireless	55 M STREET SE	PSRA	david.hill@dc.gov	Samsung Rugby Pro	David Hill
2023918197	Certified as Active	Wireless Phone/Device	Cellular	AT&T Wireless	55 M STREET SE	TOA	marvin.mcfadden@dc.gov	Samsung Rugby Pro	Marvin Mcfadden
2023918198	Certified as Active	Wireless Phone/Device	Cellular	AT&T Wireless	55 M STREET SE	PSRA	james.mccreary@dc.gov	Samsung Rugby Pro	MCCREARY JAMES
2023918199	Certified as Active	Wireless Phone/Device	Cellular	AT&T Wireless	55 M STREET SE	IPMA	Wolde.Makonnen@dc.gov	Samsung Galaxy S5	Wolde Makonnen
2023918200	Certified as Active	Wireless Phone/Device	Cellular	AT&T Wireless	55 M STREET SE	IPMA	Shanelle.Goodde@dc.gov	Samsung Galaxy S5	Shanelle Goode
2023918202	Certified as Active	Wireless Phone/Device	Cellular	AT&T Wireless	1735 15TH STREET NE	Rope	warren.fields@dc.gov	Samsung Rugby Pro	Warren Fields
2023918205	Certified as Active	Wireless Phone/Device	Cellular	AT&T Wireless	55 M STREET SE	IPMA	Ivan.Garcia@dc.gov	Samsung Rugby Pro	Ivan Garcia
2023918207	Certified as Active	Wireless Phone/Device	Cellular	AT&T Wireless	55 M STREET SE	IPMA	james.sellars@dc.gov	Samsung Rugby Pro	James Sellers
2023918210	Certified as Active	Wireless Phone/Device	Cellular	AT&T Wireless	1100 4TH STREET SW	IPMA	Ali.Zamani@dc.gov	Samsung Rugby Pro	Ali Zamani
2023918215	Certified as Active	Wireless Phone/Device	Cellular	AT&T Wireless	55 M STREET SE	IPMA	simon.rennie@dc.gov	Samsung Rugby Pro	Simon Rennie
2023918216	Certified as Active	Wireless Phone/Device	Cellular	AT&T Wireless	55 M STREET SE	IPMA	gail.skinner@dc.gov	Samsung S5	Gail Norman-Skinner
2023918220	Certified as Active	Wireless Phone/Device	Cellular	AT&T Wireless	55 M STREET SE	IPMA	Maurice.Passmore@dc.gov	Samsung S5	Maurice Passmore
2023918222	Certified as Active	Wireless Phone/Device	Cellular	AT&T Wireless	55 M STREET SE	TOA	derrick.marrow@dc.gov	Samsung Galaxy S4	Derrick Marrow
2023918226	Certified as Active	Wireless Phone/Device	Cellular	AT&T Wireless	55 M STREET SE	PSRA	Yasser.Gamil@dc.gov	Samsung S5	Yasser Gamil
2023918230	Certified as Active	Wireless Phone/Device	Cellular	AT&T Wireless	2000 14TH STREET NW	SCG	Andria.Dudley@dc.gov	Sonim Bolt SL	Andria Dudley
2023918231	Certified as Active	Wireless Phone/Device	Cellular	AT&T Wireless	55 M STREET SE	UFA	james.johnson@dc.gov	Samsung Rugby Pro	James Johnson
2023918233	Certified as Active	Wireless Phone/Device	Cellular	AT&T Wireless	55 M STREET SE	IPMA	maeLena.cephas@dc.gov	Samsung Rugby Pro	Maelena Cephas
2023918236	Certified as Active	Wireless Phone/Device	Cellular	AT&T Wireless	55 M STREET SE	5	Delante.Toyer@dc.gov	Samsung S5	Delante Toyer
2023918511	Certified as Active	Wireless Phone/Device	Cellular	AT&T Wireless	1338 G STREET SE	Signal	Todd.Wilks@dc.gov	Samsung Rugby 3	Todd Wilks
2023918513	Certified as Active	Wireless Phone/Device	Cellular	AT&T Wireless	55 M STREET SE	IPMA	Austina.Casey@dc.gov	Samsung Rugby Pro	Austina Casey
2023918515	Certified as Active	Wireless Phone/Device	Cellular	AT&T Wireless	55 M STREET SE	HR	angela.pettus@dc.gov	Samsung Rugby Pro	Angie Pettus
2023918517	Certified as Active	Wireless Phone/Device	Cellular	AT&T Wireless	55 M STREET SE	IPMA	robert.smith@dc.gov	Samsung Rugby Pro	Robert Smith
2023918519	Certified as Active	Wireless Phone/Device	Cellular	AT&T Wireless	1100 4TH STREET SW	PSRA	bernadette.edwards@dc.gov	Samsung Rugby Pro	Bernadette Edwards
2023918520	Certified as Active	Wireless Phone/Device	Cellular	AT&T Wireless	1100 4TH STREET SW	E60	Michael.Conley@dc.gov	Samsung Rugby Pro	Michael Conley
2023918756	Certified as Active	Wireless Phone/Device	Cellular	AT&T Wireless	1100 4TH STREET SW	PSRA	derrick.hardy@dc.gov	Samsung Rugby Pro	Derrick Hardy
2023918757	Certified as Active	Wireless Phone/Device	Cellular	AT&T Wireless	55 M STREET SE	IPMA	Frank.Montenegro@dc.gov	Samsung Rugby Pro	Frank Montenegro
2023918758	Certified as Active	Wireless Phone/Device	Cellular	AT&T Wireless	55 M STREET SE	IPMA	Abiodun.Oladokun@dc.gov	Samsung S5	Abiodun Oladokun
2023918759	Certified as Active	Wireless Phone/Device	Cellular	AT&T Wireless	55 M STREET SE	IPMA	Donald.Cooney@dc.gov	Samsung Rugby 3	Donald Cooney
2023918762	Certified as Active	Wireless Phone/Device	Cellular	AT&T Wireless	1403 W STREET	100	robert.callaham@dc.gov	Samsung S5	Robert Callaham
2023918763	Certified as Active	Wireless Phone/Device	Cellular	AT&T Wireless	55 M STREET SE	IPMA	Mushtaq.Maharvi@dc.gov	Samsung S5	Mushtaq Maharvi
2023918764	Certified as Active	Wireless Phone/Device	Cellular	AT&T Wireless	1403 W STREET NE	SBM	donald.johnson@dc.gov	Samsung Rugby 3	Donald Johnson
2023918766	Certified as Active	Wireless Phone/Device	Cellular	AT&T Wireless	55 M STREET SE	OITI	marlene.dixon@dc.gov	Samsung Rugby 3	Spare Number
2024090234	Certified as Active	Wireless Phone/Device	Cellular	AT&T Wireless	55 M STREET SE	PPSA	karen.gay@dc.gov	Samsung S5	Karen Gay
2024090321	Certified as Active	Wireless Phone/Device	Cellular	AT&T Wireless	1403 W STREET	SBM	iamont.hinton@dc.gov	Samsung Rugby 3	Ricardo Short
2024090389	Certified as Active	Wireless Phone/Device	Cellular	AT&T Wireless	414 FARRAGUT STREET NE	SBM	Anthony.Owens@dc.gov	Samsung S5	Anthony Owens
2024090497	Certified as Active	Wireless Phone/Device	Cellular	AT&T Wireless	414 FARRAGUT STREET NE	SBM	Jeffrey.williams@dc.gov	Samsung Galaxy S5	Jeffrey Williams
2024090830	Certified as Active	Wireless Phone/Device	Cellular	AT&T Wireless	1403 W STREET NE	SBM	barbara.willis@dc.gov	Samsung Rugby 3	Barbara Willis
2024090948	Certified as Active	Wireless Phone/Device	Cellular	AT&T Wireless	55 M STREET SE	DDOT	Princeton.Young@dc.gov	Samsung S5	Princeton Young
2024091028	Certified as Active	Wireless Phone/Device	Cellular	AT&T Wireless	55 M STREET SE	PPSA	carole.lewis@dc.gov	Samsung Rugby Pro	carole lewis
2024091029	Certified as Active	Wireless Phone/Device	Cellular	AT&T Wireless	55 M STREET SE	OITI	Etayenesh.Asfaw@dc.gov	iPhone 4s	Etayenesh Asfaw
2024091062	Certified as Active	Wireless Phone/Device	Cellular	AT&T Wireless	1403 W STREET	SB	chall.lucas@dc.gov	Samsung Rugby Pro	Chall Lucas
2024091888	Certified as Active	Wireless Phone/Device	Cellular	AT&T Wireless	414 FARRAGUT STREET NE	Foreman Trailer	robert.morris@dc.gov	Samsung Rugby Pro	Robert Morris
2024091907	Certified as Active	Wireless Phone/Device	Cellular	AT&T Wireless	55 M STREET SE	OD	amanda.stout@dc.gov	iphone 6	Amanda Stout
2024092092	Certified as Active	Wireless Phone/Device	Cellular	AT&T Wireless	1403 W STREET	SBM	Anthony.Wooten@dc.gov	Samsung S5	Anthony Wooten
2024092101	Certified as Active	Wireless Phone/Device	Cellular	AT&T Wireless	2000 14TH STREET NW	TOA	Jerome.thomas@dc.gov	Samsung Rugby 3	Jerome Thomas
2024092127	Certified as Active	Wireless Phone/Device	Cellular	AT&T Wireless	55 M STREET SE	PSRA	paul.carroway@dc.gov	Samsung Rugby 3	Paul Carraway
2024092193	Certified as Active	Wireless Phone/Device	Cellular	AT&T Wireless	1338 G STREET SE	SignFabrication	shelley.reed@dc.gov	Samsung S5	Shelley Reed
2024092199	Certified as Active	Wireless Phone/Device	Cellular	AT&T Wireless	55 M STREET SE	OITI	jon.jones@dc.gov	Samsung Galaxy s5 Active	Jon Jones
2024092201	Certified as Active	Wireless Phone/Device	Cellular	AT&T Wireless	55 M STREET SE	PTSA	circe.torruellas@dc.gov	Samsung Rugby Pro	CIRCE TORRUELLAS
2024092328	Certified as Active	Wireless Phone/Device	Cellular	AT&T Wireless	55 M STREET SE	IPMA	Obrient.Hill@dc.gov	Samsung Galaxy S5	Obrient Hill

Phone Number	STATUS	FUNCTION	SERVICE TYPE	VENDOR	SERVICE ADDRESS	ROOM	CONTACT	MODEL_NAME	CONTACT_NAME
2024092474	Certified as Active	Wireless Phone/Device	Cellular	AT&T Wireless	55 M STREET SE	NA	danielle.richardson@dc.gov	Sonim Bolt SL	Danielle Richardson
2024092599	Certified as Active	Wireless Phone/Device	Cellular	AT&T Wireless	55 M STREET SE	IPMA	Samuel.Olatunji@dc.gov	Samsung S5	Samuel Olatunji
2024092737	Certified as Active	Wireless Phone/Device	Cellular	AT&T Wireless	55 M STREET SE	TOA	reggie.mccoy@dc.gov	Samsung Rugby Pro	Reggie Mccoy
2024092768	Certified as Active	Wireless Phone/Device	Cellular	AT&T Wireless	2000 14TH STREET NW	TCO	marcus.graham@dc.gov	Samsung Rugby Pro	marcus graham
2024092775	Certified as Active	Wireless Phone/Device	Cellular	AT&T Wireless	55 M STREET SE	NA	alicia.blowe@dc.gov	Sonim Bolt SL	Alicia Blowe
2024092781	Certified as Active	Wireless Phone/Device	Cellular	AT&T Wireless	55 M STREET SE	IPMA	Tianeka.Downing@dc.gov	Samsung Rugby Pro	Tianeka Downing-Arno
2024095298	Certified as Active	Wireless Phone/Device	Cellular	AT&T Wireless	2000 14TH STREET NW	ITS	Joseph.Malloy@dc.gov	Samsung S5	Joseph Malloy
2024099184	Certified as Active	Wireless Phone/Device	Cellular	AT&T Wireless	55 M STREET SE	TOA	dwayne.norris@dc.gov	Samsung Galaxy S5	Dwayne Norris
2024099186	Certified as Active	Wireless Phone/Device	Cellular	AT&T Wireless	55 M STREET SE	IPMA	angela.nickens@dc.gov	Samsung Rugby Pro	Angela Nickens
2024099189	Certified as Active	Wireless Phone/Device	Cellular	AT&T Wireless	55 M STREET SE	N/A	Marina.Budimir@dc.gov	Samsung S5	Marina Budimir
2024099196	Certified as Active	Wireless Phone/Device	Cellular	AT&T Wireless	1338 G STREET SE	SIOD	robert.walker@dc.gov	Samsung Rugby Pro	Robert Walker
2024099197	Certified as Active	Wireless Phone/Device	Cellular	AT&T Wireless	55 M STREET SE	PPSA	jim.sebastian@dc.gov	Samsung Rugby Pro	Jim Sebastian
2024099198	Certified as Active	Wireless Phone/Device	Cellular	AT&T Wireless	55 M STREET SE	OD	jelani.lattimore@dc.gov	Samsung Rugby Pro	Jelani Lattimore
2024099200	Certified as Active	Wireless Phone/Device	Cellular	AT&T Wireless	55 M STREET SE	PSRA	david.wells@dc.gov	Samsung Rugby Pro	David Wells
2024099973	Certified as Active	Wireless Phone/Device	Cellular	AT&T Wireless	1403 W STREET	SBM	donald.ferrell@dc.gov	Samsung Rugby Pro	Donald Ferrell
2024233247	Certified as Active	Wireless Phone/Device	Cellular	AT&T Wireless	55 M STREET SE	IPMA	delmar.lytle@dc.gov	Samsung Rugby Pro	Delmar Lytle
2024233962	Certified as Active	Wireless Phone/Device	Cellular	AT&T Wireless	2000 14TH STREET NW	SCG	Bianca.smith@dc.gov	Note 4	Bianca Smith
2024236180	Certified as Active	Wireless Phone/Device	Cellular	AT&T Wireless	55 M STREET SE	IPMA	Ghirmay.Sibhatleab@dc.gov	Samsung S5	Ghirmay Sibhatleab
2024236533	Certified as Active	Wireless Phone/Device	Cellular	AT&T Wireless	55 M STREET SE	IPMA	Huntee.kim@dc.gov	Samsung Rugby Pro	Huntee Kim
2024270732	Certified as Active	Wireless Phone/Device	Cellular	AT&T Wireless	1338 G STREET SE	G St SE	maurice.richardson@dc.gov	Samsung Rugby 3	Maurice Richardson
2024270850	Certified as Active	Wireless Phone/Device	Cellular	AT&T Wireless	55 M STREET SE	IPMA	thomas.fulton@dc.gov	Samsung Rugby Pro	Thomas Fulton
2024270851	Certified as Active	Wireless Phone/Device	Cellular	AT&T Wireless	55 M STREET SE	OD	eric.stults@dc.gov	Samsung S5	Eric Stults
2024270994	Certified as Active	Wireless Phone/Device	Cellular	AT&T Wireless	55 M STREET SE	IPMA	darlene.misher@dc.gov	Samsung Rugby Pro	Darlene Misher
2024270999	Certified as Active	Wireless Phone/Device	Cellular	AT&T Wireless	2000 14TH STREET NW	SCG	Bobby.gray@dc.gov	Samsung Rugby 3	Bobby Gray
2024370609	Certified as Active	Wireless Phone/Device	Cellular	AT&T Wireless	55 M STREET SE	0	davonda.ross@dc.gov	Samsung Rugby Pro	Davonda Ross
2024370961	Certified as Active	Wireless Phone/Device	Cellular	AT&T Wireless	55 M STREET SE	IPMA	Andrea.Lowery@dc.gov	Samsung Galaxy S5	Andrea Lowery
2024371241	Certified as Active	Wireless Phone/Device	Cellular	AT&T Wireless	55 M STREET SE	TOA-ITS	jimmy.nixon@dc.gov	Samsung Rugby Pro	JIMMY NIXON
2024372847	Certified as Active	Wireless Phone/Device	Cellular	AT&T Wireless	2000 14TH STREET NW	SCG/TCO	sylvia.carter@dc.gov	Samsung Galaxy S4	Sylvia Carter
2024373735	Certified as Active	Wireless Phone/Device	Cellular	AT&T Wireless	2000 14TH STREET NW	TCO	roberto.ramirezramirez@dc.gov	Sonim Bolt SL	Roberto Ramirez
2024373780	Certified as Active	Wireless Phone/Device	Cellular	AT&T Wireless	55 M STREET SE	IPMA	Edmond.Sheffield@dc.gov	Samsung Galaxy S5	Edmond Sheffield
2024373801	Certified as Active	Wireless Phone/Device	Cellular	AT&T Wireless	55 M STREET SE	NHS Snow	ruth.claros@dc.gov	Samsung Rugby Pro	Ruth Claros
2024373807	Certified as Active	Wireless Phone/Device	Cellular	AT&T Wireless	55 M STREET SE	IPMA	Alberta.Paul@dc.gov	Samsung S5	Alberta Paul
2024373831	Certified as Active	Wireless Phone/Device	Cellular	AT&T Wireless	1338 G STREET SE	sign installat	francine.edmonds@dc.gov	Samsung Rugby 3	Carlos Cole
2024373868	Certified as Active	Wireless Phone/Device	Cellular	AT&T Wireless	55 M STREET SE	IPMA	Abdi.Salah@dc.gov	Samsung S5	Abdi Salah
2024373974	Certified as Active	Wireless Phone/Device	Cellular	AT&T Wireless	2000 14TH STREET NW	SCG	Martina.Parks@dc.gov	Sonim Bolt SL	Martina Parks
2024375368	Certified as Active	Wireless Phone/Device	Cellular	AT&T Wireless	55 M STREET SE	IPMA	Lacrecia.Fields@dc.gov	Samsung S5	Lacrecia Fields
2024376023	Certified as Active	Wireless Phone/Device	Cellular	AT&T Wireless	1403 W STREET	SBM	robert.taylor2@dc.gov	Samsung Rugby Pro	Robert Taylor
2024376347	Certified as Active	Wireless Phone/Device	Cellular	AT&T Wireless	55 M STREET SE	OITI	James.Champion@dc.gov	Sonim Bolt SL	James Champion
2024376397	Certified as Active	Wireless Phone/Device	Cellular	AT&T Wireless	414 FARRAGUT STREET NE	Farragut	james.strange@dc.gov	iphone 6	JAMES STRANGE
2024376484	Certified as Active	Wireless Phone/Device	Cellular	AT&T Wireless	55 M STREET SE	OD	rodney.sutton@dc.gov	iphone 6S	Rodney Sutton
2024376720	Certified as Active	Wireless Phone/Device	Cellular	AT&T Wireless	1403 W STREET	100	lawrence.jackson@dc.gov	Samsung Rugby 3	Lawrence Jackson
2024376800	Certified as Active	Wireless Phone/Device	Cellular	AT&T Wireless	1338 G STREET SE	FOD	Santini.Leary@dc.gov	Sonim Bolt SL	Santini Leary
2024377248	Certified as Active	Wireless Phone/Device	Cellular	AT&T Wireless	2000 14TH STREET NW	SCG	Dimitri.dyson@dc.gov	Samsung Rugby 3	Dimitri Dyson
2024377648	Certified as Active	Wireless Phone/Device	Cellular	AT&T Wireless	55 M STREET SE	OD	Margaret.Crane@dc.gov	Samsung Galaxy S 5	Margaret Crane
2024377824	Certified as Active	Wireless Phone/Device	Cellular	AT&T Wireless	55 M STREET SE	TOA	jason.blevins@dc.gov	Samsung Rugby Pro	JASON BLEVINS
2024377842	Certified as Active	Wireless Phone/Device	Cellular	AT&T Wireless	2000 14TH STREET NW	SCG	jacqueline.reynolds@dc.gov	Samsung Rugby 3	Jacqueline Reynolds
2024377950	Certified as Active	Wireless Phone/Device	Cellular	AT&T Wireless	1403 W STREET	SBM	joanell.lott@dc.gov	Samsung Rugby Pro	Joanell lott
2024378119	Certified as Active	Wireless Phone/Device	Cellular	AT&T Wireless	55 M STREET SE	IPMA	sonya.briscoe@dc.gov	Samsung Rugby Pro	Sonya Briscoe
2024378863	Certified as Active	Wireless Phone/Device	Cellular	AT&T Wireless	1403 W STREET	Lower Level	james.clayton@dc.gov	Samsung Rugby 3	James Clayton
2024387452	Certified as Active	Wireless Phone/Device	Cellular	AT&T Wireless	1403 W STREET	SBM	Clifford.Lancaster@dc.gov	Samsung Galaxy S5	Clifford Lancaster
2024387498	Certified as Active	Wireless Phone/Device	Cellular	AT&T Wireless	1338 G STREET SE	1	Lemar.Richardson@dc.gov	Samsung Rugby 3	Lemar Richardson
2024387517	Certified as Active	Wireless Phone/Device	Cellular	AT&T Wireless	1338 G STREET SE	FOD	Gregory.Granberry@dc.gov	Samsung Rugby Pro	Gregory Granberry
2024387542	Certified as Active	Wireless Phone/Device	Cellular	AT&T Wireless	55 M STREET SE	PSRA	ronald.tate@dc.gov	Samsung Rugby Pro	Ronald Tate
2024387719	Certified as Active	Wireless Phone/Device	Cellular	AT&T Wireless	2000 14TH STREET NW	SCG	linice.alston@dc.gov	Samsung Rugby 3	Linice Alston
2024387726	Certified as Active	Wireless Phone/Device	Cellular	AT&T Wireless	414 FARRAGUT STREET NE	TOA	michael.wilson@dc.gov	Samsung Rugby 3	Michael Wilson
2024387770	Certified as Active	Wireless Phone/Device	Cellular	AT&T Wireless	414 FARRAGUT STREET NE	SBM	Robert.McNeely@dc.gov	Samsung Rugby Pro	Robert McNeely
2024387942	Certified as Active	Wireless Phone/Device	Cellular	AT&T Wireless	1403 W STREET NE	SBM	hasannajm.taqee@dc.gov	Samsung Rugby 3	Hasan Taqee

Phone Number	STATUS	FUNCTION	SERVICE TYPE	VENDOR	SERVICE ADDRESS	ROOM	CONTACT	MODEL_NAME	CONTACT_NAME
2024387946	Certified as Active	Wireless Phone/Device	Cellular	AT&T Wireless	55 M STREET SE	UFA	Kenya.lomax@dc.gov	Samsung Rugby 3	Kenya Lomax
2024388136	Certified as Active	Wireless Phone/Device	Cellular	AT&T Wireless	1338 G STREET SE	SOD	valerie.wiggins@dc.gov	Samsung Rugby Pro	VALERIE WIGGINS
2024388166	Certified as Active	Wireless Phone/Device	Cellular	AT&T Wireless	1338 G STREET SE	TOA-ITS	Jermaine.Johnson@dc.gov	Samsung Galaxy S5	Jermaine Johnson
2024388550	Certified as Active	Wireless Phone/Device	Cellular	AT&T Wireless	55 M STREET SE	PTSA	lewis.booker@dc.gov	Samsung Galaxy S5	Lewis Booker
2024388601	Certified as Active	Wireless Phone/Device	Cellular	AT&T Wireless	2000 14TH STREET NW	SCG	earl.womble@dc.gov	Samsung Rugby 3	Earl Womble
2024388607	Certified as Active	Wireless Phone/Device	Cellular	AT&T Wireless	55 M STREET SE	IPMA/Asset Mana	Simon.Rennie@dc.gov	Samsung Rugby Pro	Simon Rennie
2024388616	Certified as Active	Wireless Phone/Device	Cellular	AT&T Wireless	55 M STREET SE	IPMA	Adolfo.Nino@dc.gov	Samsung Rugby Pro	Adolfo Nino
2024388828	Certified as Active	Wireless Phone/Device	Cellular	AT&T Wireless	1403 W STREET	SBM	tensy.simpson@dc.gov	Samsung Rugby 3	Tensy Simpson
2024388829	Certified as Active	Wireless Phone/Device	Cellular	AT&T Wireless	2000 14TH STREET NW	SCG	stacy.harvey@dc.gov	Samsung Rugby 3	Stacy Harvey
2024388831	Certified as Active	Wireless Phone/Device	Cellular	AT&T Wireless	55 M STREET SE	HR	ndumba.lutangu2@dc.gov	Samsung Galaxy s5 Active	Ndumba Lutangu
2024388904	Certified as Active	Wireless Phone/Device	Cellular	AT&T Wireless	55 M STREET SE	SIOD	derrick.perry@dc.gov	Kyocera Device	Derrick Perry
2024388919	Certified as Active	Wireless Phone/Device	Cellular	AT&T Wireless	1338 G STREET SE	TOA	Devon.Smith@dc.gov	Samsung Galaxy s5 Active	Devon Smith
2024388928	Certified as Active	Wireless Phone/Device	Cellular	AT&T Wireless	55 M STREET SE	IPMA	Gholam.Agahi@dc.gov	Samsung S5	Gholam Agahi
2024388944	Certified as Active	Wireless Phone/Device	Cellular	AT&T Wireless	55 M STREET SE	PSRA	Donna.stewart@dc.gov	Samsung Rugby Pro	DONNA Stewart
2024388951	Certified as Active	Wireless Phone/Device	Cellular	AT&T Wireless	2000 14TH STREET NW	SCG	crossing.guard@dc.gov	Samsung Rugby 3	Gloria Profit
2024388959	Certified as Active	Wireless Phone/Device	Cellular	AT&T Wireless	55 M STREET SE	UFA	jimmy.phillips@dc.gov	Samsung Rugby 3	Jimmy Phillips
2024388960	Certified as Active	Wireless Phone/Device	Cellular	AT&T Wireless	55 M STREET SE	IPMA	Kenneth.Mason@dc.gov	Samsung Rugby Pro	Kenneth Mason
2024388967	Certified as Active	Wireless Phone/Device	Cellular	AT&T Wireless	55 M STREET SE	PSRA	vacara.matthews@dc.gov	Samsung S5	Vacara Matthews
2024388969	Certified as Active	Wireless Phone/Device	Cellular	AT&T Wireless	55 M STREET SE	OD	ralph.hawkins@dc.gov	Samsung S5	Ralph Hawkins
2024388973	Certified as Active	Wireless Phone/Device	Cellular	AT&T Wireless	1100 4TH STREET SW	PSRA	edward.neugent@dc.gov	Samsung Rugby 3	Edward Neugent
2024388976	Certified as Active	Wireless Phone/Device	Cellular	AT&T Wireless	55 M STREET SE	IPMA	ola.igbo-osagie@dc.gov	Samsung Rugby Pro	Ola Igbo-Osagie
2024389262	Certified as Active	Wireless Phone/Device	Cellular	AT&T Wireless	55 M STREET SE	PSRA	Kimberly.lucas@dc.gov	Samsung Rugby Pro	kimberly lucas
2024389391	Certified as Active	Wireless Phone/Device	Cellular	AT&T Wireless	55 M STREET SE	OITI	mohamed.said@dc.gov	iPhone 5s	Mohamed Said
2024389488	Certified as Active	Wireless Phone/Device	Cellular	AT&T Wireless	1403 W STREET NE	SBM	myron.gross@dc.gov	Samsung S5	Myron Gross
2024389524	Certified as Active	Wireless Phone/Device	Cellular	AT&T Wireless	55 M STREET SE	IPMA	anthony.jackson2@dc.gov	Samsung Rugby Pro	Anthony Jackson
2024389581	Certified as Active	Wireless Phone/Device	Cellular	AT&T Wireless	55 M STREET SE	TCO/SCG	lanel.sartin@dc.gov	Samsung Rugby Pro	SNOW 13 PHONE
2024389630	Certified as Active	Wireless Phone/Device	Cellular	AT&T Wireless	414 FARRAGUT STREET NE	Snow	melony.pree@dc.gov	Sonim XP1520	Snow #16 Phone
2024389772	Certified as Active	Wireless Phone/Device	Cellular	AT&T Wireless	55 M STREET SE	PSRA	John.Stokes4@dc.gov	Samsung Rugby Pro	John Stokes
2024389929	Certified as Active	Wireless Phone/Device	Cellular	AT&T Wireless	2000 14TH STREET NW	SGC	jackie.boggs@dc.gov	Samsung Rugby 3	Jackie Boggs
2024390691	Certified as Active	Wireless Phone/Device	Cellular	AT&T Wireless	55 M STREET SE	IPMA	cornelious.phillips@dc.gov	Samsung Rugby Pro	Cornelious Phillips
2024391159	Certified as Active	Wireless Phone/Device	Cellular	AT&T Wireless	1403 W STREET	SBM	gary.jackson@dc.gov	Kyocera Device	Gary Jackson
2024391160	Certified as Active	Wireless Phone/Device	Cellular	AT&T Wireless	1338 G STREET SE	signal	William.wilson@dc.gov	Samsung S5	William Wilson
2024391161	Certified as Active	Wireless Phone/Device	Cellular	AT&T Wireless	55 M STREET SE	IPMA	kristy.hymes@dc.gov	Samsung Rugby Pro	Kristy Hymes
2024391222	Certified as Active	Wireless Phone/Device	Cellular	AT&T Wireless	414 FARRAGUT STREET NE	Snow-Phone	melony.pree@dc.gov	Sonim XP1520	Snow 1 Phone
2024391223	Certified as Active	Wireless Phone/Device	Cellular	AT&T Wireless	2000 14TH STREET NW	SCG	tamia.foster@dc.gov	Samsung Rugby 3	Tamia Foster
2024391229	Certified as Active	Wireless Phone/Device	Cellular	AT&T Wireless	1338 G STREET SE	G ST	charles.stewart3@dc.gov	Samsung Rugby Pro	CHARLES STEWART
2024391230	Certified as Active	Wireless Phone/Device	Cellular	AT&T Wireless	2000 14TH STREET NW	SCG	alice.mcphatter@dc.gov	Samsung Rugby 3	Alice McPhatter
2024391231	Certified as Active	Wireless Phone/Device	Cellular	AT&T Wireless	55 M STREET SE	OD	Charnita.walker@dc.gov	Samsung Rugby Pro	Charnita Walker
2024391458	Certified as Active	Wireless Phone/Device	Cellular	AT&T Wireless	1338 G STREET SE	TOA	joseph.moore@dc.gov	Samsung S5	Joseph Moore
2024394139	Certified as Active	Wireless Phone/Device	Cellular	AT&T Wireless	55 M STREET SE	PPSA	charles.thomas3@dc.gov	Samsung Rugby Pro	Charles Thomas
2024394179	Certified as Active	Wireless Phone/Device	Cellular	AT&T Wireless	2000 14TH STREET NW	SCG	Tonyac.Lewis@dc.gov	Samsung Rugby 3	Tonyac Lewis
2024394440	Certified as Active	Wireless Phone/Device	Cellular	AT&T Wireless	1735 15TH STREET NE	Warehouse	bradley.mason@dc.gov	Note 4	Bradley Mason
2024394448	Certified as Active	Wireless Phone/Device	Cellular	AT&T Wireless	55 M STREET SE	IPMA	Larry.Chung@dc.gov	Samsung Rugby Pro	Larry Chung
2024394514	Certified as Active	Wireless Phone/Device	Cellular	AT&T Wireless	2000 14TH STREET NW	TOA	jacquelyn.thomas@dc.gov	Samsung Rugby Pro	JACKIE THOMAS
2024394628	Certified as Active	Wireless Phone/Device	Cellular	AT&T Wireless	55 M STREET SE	OITI	Reginald.Arno@dc.gov	Samsung Galaxy S4	Reginald Arno
2024394669	Certified as Active	Wireless Phone/Device	Cellular	AT&T Wireless	2000 14TH STREET NW	TCO	Delonte.claggett@dc.gov	Samsung Rugby 3	Delonte Claggett
2024394711	Certified as Active	Wireless Phone/Device	Cellular	AT&T Wireless	55 M STREET SE	PSOP	edgar.proctor@dc.gov	Samsung Rugby Pro	Edgar Proctor
2024394715	Certified as Active	Wireless Phone/Device	Cellular	AT&T Wireless	1338 G STREET SE	TOA-ITS	taweh.cooper@dc.gov	iPhone 4s	Taweh Cooper
2024394796	Certified as Active	Wireless Phone/Device	Cellular	AT&T Wireless	55 M STREET SE	OITI	Yared.Tesfaye@dc.gov	Samsung S5	Yared Tesfaye
2024395044	Certified as Active	Wireless Phone/Device	Cellular	AT&T Wireless	55 M STREET SE	IPMA	Patrick.Ogbeide@dc.gov	Samsung Galaxy S5	Patrick Ogbeide
2024395045	Certified as Active	Wireless Phone/Device	Cellular	AT&T Wireless	55 M STREET SE	Public Space In	oluwaseun.obadare@dc.gov	Samsung Rugby Pro	Oluwaseun Obadare
2024395046	Certified as Active	Wireless Phone/Device	Cellular	AT&T Wireless	55 M STREET SE	TOA	steven.gross@dc.gov	Samsung Rugby Pro	Steven Gross
2024395096	Certified as Active	Wireless Phone/Device	Cellular	AT&T Wireless	55 M STREET SE	IPMA	tracy.coles@dc.gov	Samsung S5	Tracy Coles-Thomas
2024395352	Certified as Active	Wireless Phone/Device	Cellular	AT&T Wireless	55 M STREET SE	PSRA	John.Stevens@dc.gov	Samsung Rugby Pro	John Stevens
2024397237	Certified as Active	Wireless Phone/Device	Cellular	AT&T Wireless	2000 14TH STREET NW	TOA-ITS	Tammie.jones@dc.gov	Mega 2	Tammie Jones
2024463759	Certified as Active	Wireless Phone/Device	Cellular	AT&T Wireless	55 M STREET SE	PSRA	gary.blunt@dc.gov	Samsung Rugby Pro	Gary Blunt
2024463760	Certified as Active	Wireless Phone/Device	Cellular	AT&T Wireless	1403 W STREET	TOA	james.glaspie@dc.gov	Samsung Rugby 3	james glaspie

Phone Number	STATUS	FUNCTION	SERVICE TYPE	VENDOR	SERVICE ADDRESS	ROOM	CONTACT	MODEL_NAME	CONTACT_NAME
2024463815	Certified as Active	Wireless Phone/Device	Cellular	AT&T Wireless	55 M STREET SE	PSRA	elliott.garrett@dc.gov	Samsung S5	Elliott Garrett
2024659041	Certified as Active	Wireless Phone/Device	Cellular	AT&T Wireless	55 M STREET SE	IPMA	Daniel.Afolabi@dc.gov	Samsung Rugby Pro	Daniel Afolabi
2024659533	Certified as Active	Wireless Phone/Device	Cellular	AT&T Wireless	55 M STREET SE	PSRA	mildred.summers@dc.gov	Samsung Rugby Pro	Mildred Summers
2024865039	Certified as Active	Wireless Phone/Device	Cellular	AT&T Wireless	2000 14TH STREET NW	SCG	ameka.walker@dc.gov	Samsung Rugby 3	Ameka Walker
2024865307	Certified as Active	Wireless Phone/Device	Cellular	AT&T Wireless	55 M STREET SE	Training	Charlotte.Alston@dc.gov	Samsung Rugby Pro	Charolotte Alston
2024970013	Certified as Active	Wireless Phone/Device	Cellular	AT&T Wireless	1735 15TH STREET NE	Rope	Michele.dearing@dc.gov	Samsung Rugby Pro	Michele Dearing
2024970061	Certified as Active	Wireless Phone/Device	Cellular	AT&T Wireless	1100 4TH STREET SW	PSRA	lavar.youmans@dc.gov	Samsung Rugby 3	Lavar Youman
2024970080	Certified as Active	Wireless Phone/Device	Cellular	AT&T Wireless	55 M STREET SE	DDOT	arthur.yant@dc.gov	Samsung Rugby Pro	Arthur Yant
2024970124	Certified as Active	Wireless Phone/Device	Cellular	AT&T Wireless	55 M STREET SE	Communication	michelle.phipps-evans@dc.gov	iphone 6S	Michelle Phipps-Evans
2024971316	Certified as Active	Wireless Phone/Device	Cellular	AT&T Wireless	55 M STREET SE	IPMA	Samuel.Ayodele@dc.gov	Samsung Galaxy S5	Samuel Ayodele
2024971608	Certified as Active	Wireless Phone/Device	Cellular	AT&T Wireless	1338 G STREET SE	SIOD	francine.edmonds@dc.gov	Samsung Galaxy S5	FRANCINE EDMONDS
2024971610	Certified as Active	Wireless Phone/Device	Cellular	AT&T Wireless	400 MCMILLAN DRIVE NW	ipma	Bipinbhai.Patel@dc.gov	Samsung Galaxy S5	Bipinbhai Patel
2024971624	Certified as Active	Wireless Phone/Device	Cellular	AT&T Wireless	414 FARRAGUT STREET NE	TOA	derrick.nobles@dc.gov	Samsung Rugby Pro	Derrick Nobles
2024971648	Certified as Active	Wireless Phone/Device	Cellular	AT&T Wireless	55 M STREET SE	DDOT-IPMA	Matthew.Gana@dc.gov	Samsung Rugby Pro	Matthew Gana
2024971899	Certified as Active	Wireless Phone/Device	Cellular	AT&T Wireless	55 M STREET SE	IPMA	Morgan.Prince@dc.gov	Samsung S5	Morgan Prince
2024971917	Certified as Active	Wireless Phone/Device	Cellular	AT&T Wireless	55 M STREET SE	TOA	james.henry@dc.gov	Samsung Rugby Pro	Emergency Office Phone
2024972706	Certified as Active	Wireless Phone/Device	Cellular	AT&T Wireless	2000 14TH STREET NW	SCG	Dominique.Copeland@dc.gov	Samsung Galaxy S5	Dominique Copeland
2024972813	Certified as Active	Wireless Phone/Device	Cellular	AT&T Wireless	55 M STREET SE	PSRA	Charlene.Dickens@dc.gov	Samsung Rugby Pro	Charlene Dickens
2024972856	Certified as Active	Wireless Phone/Device	Cellular	AT&T Wireless	1403 W STREET NE	SBM	brenda.johnson@dc.gov	Samsung Galaxy S5	Brenda Johnson
2024972943	Certified as Active	Wireless Phone/Device	Cellular	AT&T Wireless	55 M STREET SE	TOA	richard.turner@dc.gov	Samsung Galaxy S5	Richard Turner
2024973028	Certified as Active	Wireless Phone/Device	Cellular	AT&T Wireless	1100 4TH STREET SW	PSRA	frank.morris@dc.gov	Samsung Rugby 3	Frank Morris
2024973044	Certified as Active	Wireless Phone/Device	Cellular	AT&T Wireless	1403 W STREET	SBM	Willie.Salmon@dc.gov	Samsung Rugby 3	Willie Salmon
2024973078	Certified as Active	Wireless Phone/Device	Cellular	AT&T Wireless	55 M STREET SE	IPMA	Alfred.Strange@dc.gov	Samsung S5	Alfred Strange
2024973223	Certified as Active	Wireless Phone/Device	Cellular	AT&T Wireless	55 M STREET SE	IPMA	Ramesh.Mirchandani@dc.gov	Samsung Galaxy S5	Ramesh Mirchandani
2024973316	Certified as Active	Wireless Phone/Device	Cellular	AT&T Wireless	1338 G STREET SE	FOD	robert.payton@dc.gov	Samsung Rugby Pro	Robert Payton
2024973510	Certified as Active	Wireless Phone/Device	Cellular	AT&T Wireless	1403 W STREET	868B	Kenneth.Smith5@dc.gov	Samsung S5	Kenneth Smith
2024973519	Certified as Active	Wireless Phone/Device	Cellular	AT&T Wireless	1340 G ST SE #REAR STREET SE	1st floor	Michael.McIntosh@dc.gov	Samsung S5	Michael McIntosh
2024973523	Certified as Active	Wireless Phone/Device	Cellular	AT&T Wireless	1100 4TH STREET SW	PSRA	Michelle.mosley@dc.gov	Samsung Rugby 3	Michelle Mosley
2024973527	Certified as Active	Wireless Phone/Device	Cellular	AT&T Wireless	2000 14TH STREET NW	SCG	danielle.young@dc.gov	Samsung Rugby Pro	DANIELLE YOUNG
2024973531	Certified as Active	Wireless Phone/Device	Cellular	AT&T Wireless	55 M STREET SE	OITI	jose.colon@dc.gov	iPhone 6+	Jose Colon
2024973533	Certified as Active	Wireless Phone/Device	Cellular	AT&T Wireless	1100 4TH STREET SW	OD	yvette.conley@dc.gov	Samsung Rugby Pro	Yvette Conley
2024973537	Certified as Active	Wireless Phone/Device	Cellular	AT&T Wireless	55 M STREET SE	PSRA	keenan.meaders@dc.gov	Samsung Rugby Pro	Keenan Meaders
2024973545	Certified as Active	Wireless Phone/Device	Cellular	AT&T Wireless	1338 G STREET SE	TOA-ITS	gerald.carter@dc.gov	Samsung Rugby 3	Gerald Carter
2024973645	Certified as Active	Wireless Phone/Device	Cellular	AT&T Wireless	55 M STREET SE	N/A	anthony.lawson@dc.gov	Samsung Galaxy S5	Anthony Lawson
2024973750	Certified as Active	Wireless Phone/Device	Cellular	AT&T Wireless	55 M STREET SE	IPMA	Jerome.Hackney@dc.gov	Samsung Rugby 3	Jerome Hackney
2024973776	Certified as Active	Wireless Phone/Device	Cellular	AT&T Wireless	55 M STREET SE	Citywide	Ohene.Ofosu@dc.gov	Samsung Rugby Pro	Ohene Ofosu
2024973948	Certified as Active	Wireless Phone/Device	Cellular	AT&T Wireless	1338 G STREET SE	Facility	gregory.simmons@dc.gov	Samsung Rugby Pro	Gregory Simmons
2024973953	Certified as Active	Wireless Phone/Device	Cellular	AT&T Wireless	55 M STREET SE	IPMA	Nanette.Bowles@dc.gov	Samsung Rugby Pro	Nanette Bowles
2024973982	Certified as Active	Wireless Phone/Device	Cellular	AT&T Wireless	414 FARRAGUT STREET NE	Snow	melony.pree@dc.gov	Sonim XP1520	Snow #17 Phone
2024973986	Certified as Active	Wireless Phone/Device	Cellular	AT&T Wireless	2000 14TH STREET NW	200	maurice.philson@dc.gov	Samsung S5	Maurice Philson
2024973993	Certified as Active	Wireless Phone/Device	Cellular	AT&T Wireless	2000 14TH STREET NW	TCO	lacresha.bailey@dc.gov	Note 4	Lacresha Bailey
2024973996	Certified as Active	Wireless Phone/Device	Cellular	AT&T Wireless	55 M STREET SE	IPMA	Wanda.Pinn-Mills@dc.gov	Samsung Rugby Pro	Wanda Pinn-Mills
2024973998	Certified as Active	Wireless Phone/Device	Cellular	AT&T Wireless	2000 14TH STREET NW	TOA	George.Davis@dc.gov	Kyocera Device	George Davis
2024974183	Certified as Active	Wireless Phone/Device	Cellular	AT&T Wireless	55 M STREET SE	IPMA	Wayne.wilson@dc.gov	Samsung Rugby Pro	Wayne Wilson
2024974291	Certified as Active	Wireless Phone/Device	Cellular	AT&T Wireless	1403 W STREET	UFA	jerry.darden@dc.gov	Samsung Rugby 3	Jerry Darden
2024974533	Certified as Active	Wireless Phone/Device	Cellular	AT&T Wireless	1735 15TH STREET NE	Warehouse	jacqueline.jones3@dc.gov	Samsung Rugby Pro	jackie jones
2024974570	Certified as Active	Wireless Phone/Device	Cellular	AT&T Wireless	1100 4TH STREET SW	IPMA	Edwin.Edokwe@dc.gov	Samsung Galaxy S5	Edwin Edokwe
2024974707	Certified as Active	Wireless Phone/Device	Cellular	AT&T Wireless	55 M STREET SE	IPMA	Vincent.Carter@dc.gov	Samsung S5	Vincent Carter
2024974714	Certified as Active	Wireless Phone/Device	Cellular	AT&T Wireless	2000 14TH STREET NW	SCG	Holly.reed@dc.gov	Samsung Rugby 3	Holly Reed
2024974716	Certified as Active	Wireless Phone/Device	Cellular	AT&T Wireless	55 M STREET SE	TOA	jerry.lyle@dc.gov	Samsung Rugby Pro	JERRY LYLE
2024974718	Certified as Active	Wireless Phone/Device	Cellular	AT&T Wireless	55 M STREET SE	TOA	michael.miller4@dc.gov	Samsung Rugby Pro	Michael miller
2024974720	Certified as Active	Wireless Phone/Device	Cellular	AT&T Wireless	2000 14TH STREET NW	TCO	comontae.middleton@dc.gov	Note 4	comontae middleton
2024974722	Certified as Active	Wireless Phone/Device	Cellular	AT&T Wireless	55 M STREET SE	OD	brett.rouillier@dc.gov	Samsung S5	Brett Rouillier
2024974731	Certified as Active	Wireless Phone/Device	Cellular	AT&T Wireless	1403 W STREET	UFA	john.thomas@dc.gov	Samsung Rugby 3	Charles Whalen
2024975068	Certified as Active	Wireless Phone/Device	Cellular	AT&T Wireless	55 M STREET SE	OD	Duane.Hill@dc.gov	Samsung S5	Duane Hill
2024976515	Certified as Active	Wireless Phone/Device	Cellular	AT&T Wireless	55 M STREET SE	IPMA	antania.henderson@dc.gov	Samsung Galaxy S5	antania HENDERSON
2024976793	Certified as Active	Wireless Phone/Device	Cellular	AT&T Wireless	1403 W STREET	sbm	marlene.dixon@dc.gov	Samsung Rugby Pro	Seasonal Standby

Phone Number	STATUS	FUNCTION	SERVICE TYPE	VENDOR	SERVICE ADDRESS	ROOM	CONTACT	MODEL_NAME	CONTACT_NAME
2024977144	Certified as Active	Wireless Phone/Device	Cellular	AT&T Wireless	1403 W STREET	SBM	Roland.Jones@dc.gov	Samsung S5	Roland Jones
2024977146	Certified as Active	Wireless Phone/Device	Cellular	AT&T Wireless	1100 4TH STREET SW	PSRA	Pamela.Wilson@dc.gov	Samsung Rugby Pro	Pamela Wilson
2024977148	Certified as Active	Wireless Phone/Device	Cellular	AT&T Wireless	1403 W STREET	SBM	Lucius.Thompson2@dc.gov	Samsung Rugby 3	Lucius Thompson
2024977153	Certified as Active	Wireless Phone/Device	Cellular	AT&T Wireless	55 M STREET SE	DDOT	Michael.Alvino@dc.gov	Samsung S5	Michael Alvino
2024977157	Certified as Active	Wireless Phone/Device	Cellular	AT&T Wireless	55 M STREET SE	IPMA	Jason.Griffin@dc.gov	Samsung S5	Jason Griffin
2024977159	Certified as Active	Wireless Phone/Device	Cellular	AT&T Wireless	55 M STREET SE	PSRA	kenneth.toyer@dc.gov	Samsung Rugby Pro	Kenneth Toyer
2024977161	Certified as Active	Wireless Phone/Device	Cellular	AT&T Wireless	1403 W STREET	SBM	anthony.miller2@dc.gov	Samsung Galaxy S5	Anthony Miller
2024977163	Certified as Active	Wireless Phone/Device	Cellular	AT&T Wireless	1403 W STREET	SBM	ronald.miller@dc.gov	Samsung Rugby 3	Ronald Miller
2024977169	Certified as Active	Wireless Phone/Device	Cellular	AT&T Wireless	55 M STREET SE	IPMA	Amy.Jacobi@dc.gov	Kyocera Device	Amy Jacobi
2024977178	Certified as Active	Wireless Phone/Device	Cellular	AT&T Wireless	1403 W STREET	SBM	michael.jackson4@dc.gov	Samsung S5	Michael Jackson
2024977204	Certified as Active	Wireless Phone/Device	Cellular	AT&T Wireless	1338 G STREET SE	TOA	Quinn.Lindsay@dc.gov	Samsung S5	lindsay quinn
2024977208	Certified as Active	Wireless Phone/Device	Cellular	AT&T Wireless	1403 W STREET	TOA	anthony.bell@dc.gov	Samsung S5	Anthony Bell
2024977214	Certified as Active	Wireless Phone/Device	Cellular	AT&T Wireless	55 M STREET SE	TOA-ITS	luis.roa@dc.gov	Samsung S5	Luis Roa
2024977789	Certified as Active	Wireless Phone/Device	Cellular	AT&T Wireless	55 M STREET SE	UFA	jehrel.thurston@dc.gov	Samsung Galaxy S5	Jehrel Thurston
2024977799	Certified as Active	Wireless Phone/Device	Cellular	AT&T Wireless	55 M STREET SE	STREETCAR	ERROL.WILLIAMS@dc.gov	Samsung Rugby Pro	ERROL WILLIAMS
2024977804	Certified as Active	Wireless Phone/Device	Cellular	AT&T Wireless	55 M STREET SE	IPMA	Phillips.Folayan@dc.gov	Samsung S5	Phillips Folayan
2024977864	Certified as Active	Wireless Phone/Device	Cellular	AT&T Wireless	55 M STREET SE	IPMA	eric.cole@dc.gov	Samsung Galaxy S5	Eric Cole
2024978038	Certified as Active	Wireless Phone/Device	Cellular	AT&T Wireless	64 NEW YORK AVENUE NE	IPMA	Daniel.Nabu@dc.gov	Samsung S5	Daniel Nabu
2024978074	Certified as Active	Wireless Phone/Device	Cellular	AT&T Wireless	55 M STREET SE	TOA	darrell.smith@dc.gov	Samsung Rugby Pro	Darrell Smith
2024978089	Certified as Active	Wireless Phone/Device	Cellular	AT&T Wireless	55 M STREET SE	0	debra.walker@dc.gov	Samsung Rugby 3	Debra Walker
2024978234	Certified as Active	Wireless Phone/Device	Cellular	AT&T Wireless	2000 14TH STREET NW	SCG	deborah.taylor-womack@dc.gov	Samsung Rugby 3	Deborah Taylor-Womack
2024978366	Certified as Active	Wireless Phone/Device	Cellular	AT&T Wireless	414 FARRAGUT STREET NE	OITI	melony.pree@dc.gov	Sonim XP1520	Snow #8 Phone
2024979024	Certified as Active	Wireless Phone/Device	Cellular	AT&T Wireless	55 M STREET SE	Davis Bacon Div	Tanisha.Mcneil@dc.gov	Samsung Rugby 3	Tanisha Mcneil
2024988779	Certified as Active	Wireless Phone/Device	Cellular	AT&T Wireless	55 M STREET SE	IPMA	gregory.marshall@dc.gov	Kyocera Device	Gregory Marshall
2024988797	Certified as Active	Wireless Phone/Device	Cellular	AT&T Wireless	1403 W STREET NE	SBM	John.gaines@dc.gov	Samsung S5	John Gaines
2024989005	Certified as Active	Wireless Phone/Device	Cellular	AT&T Wireless	1100 4TH STREET SW	PSRA	domanika.green@dc.gov	Samsung Rugby 3	Domanika Green
2024989912	Certified as Active	Wireless Phone/Device	Cellular	AT&T Wireless	55 M STREET SE	TOA	brook.hailemariam@dc.gov	Samsung Rugby Pro	BROOK HAILEMARIAM
2025286135	Certified as Active	Wireless Phone/Device	Cellular	AT&T Wireless	1735 15TH STREET NE	Fleet	vicki.davis@dc.gov	Samsung Rugby Pro	Vicki Davis
2025288444	Certified as Active	Wireless Phone/Device	Cellular	AT&T Wireless	1403 W STREET	TOA	Keonne.wheeler@dc.gov	Samsung Rugby 3	Keonne Wheeler
2025289380	Certified as Active	Wireless Phone/Device	Cellular	AT&T Wireless	1403 W STREET	SBM	Johnnie.Treadwell@dc.gov	Samsung S5	Johnnie Treadwell
2025289755	Certified as Active	Wireless Phone/Device	Cellular	AT&T Wireless	1338 G STREET SE	TOA	Cheryl.Harvin@dc.gov	Samsung S5	Cheryl Harvin
2025289763	Certified as Active	Wireless Phone/Device	Cellular	AT&T Wireless	55 M STREET SE	PSRA	haywood.richardson@dc.gov	Samsung Rugby Pro	Haywood Richardson
2025289764	Certified as Active	Wireless Phone/Device	Cellular	AT&T Wireless	1403 W STREET	SBM	benjamin.wheeler@dc.gov	Sonim Bolt SL	Benjamin Wheeler
2025317569	Certified as Active	Wireless Phone/Device	Cellular	AT&T Wireless	55 M STREET SE	OITI	jose.colon@dc.gov	Samsung Galaxy S4	Jose Colon
2025382146	Certified as Active	Wireless Phone/Device	Cellular	AT&T Wireless	55 M STREET SE	OD	evelyn.dare@dc.gov	Kyocera Device	Evelyn Dare
2025538397	Certified as Active	Wireless Phone/Device	Cellular	AT&T Wireless	55 M STREET SE	TOA	rebecca.hazlett@dc.gov	Samsung Rugby Pro	rebecca hazlett
2029041303	Certified as Active	Wireless Phone/Device	Cellular	AT&T Wireless	55 M STREET SE	Managers on Cal	marlene.dixon@dc.gov	Samsung Galaxy S5	Managers On Call
2029043780	Certified as Active	Wireless Phone/Device	Cellular	AT&T Wireless	55 M STREET SE	PPSA	Gabe.onyeador@dc.gov	Samsung S5	Gabe Onyeador
2029043852	Certified as Active	Wireless Phone/Device	Cellular	AT&T Wireless	55 M STREET SE	OITI	turnesha.fish@dc.gov	Samsung Rugby Pro	Turnesha Fish
2029053558	Certified as Active	Wireless Phone/Device	Cellular	AT&T Wireless	55 M STREET SE	OITI	Derrick.Jones@dc.gov	Samsung S5	Derrick Jones
2029077006	Certified as Active	Wireless Phone/Device	Cellular	AT&T Wireless	2000 14TH STREET NW	SCG	Symra.Dunbar@dc.gov	Sonim Bolt SL	Symra Dunbar
2029077008	Certified as Active	Wireless Phone/Device	Cellular	AT&T Wireless	2000 14TH STREET NW	TOA/TCO	tracey.ellington@dc.gov	Samsung Rugby 3	Tracey Ellington
2029077009	Certified as Active	Wireless Phone/Device	Cellular	AT&T Wireless	2000 14TH STREET NW	TCO	traci.west@dc.gov	Samsung Rugby 3	Traci West
2029077014	Certified as Active	Wireless Phone/Device	Cellular	AT&T Wireless	2000 14TH STREET NW	TCO	Coneice.Britton@dc.gov	Samsung Rugby 3	Coneice Britton
2029077015	Certified as Active	Wireless Phone/Device	Cellular	AT&T Wireless	2000 14TH STREET NW	TCO	ashley.blanding@dc.gov	Samsung Rugby 3	Ashley Blanding
2029077034	Certified as Active	Wireless Phone/Device	Cellular	AT&T Wireless	2000 14TH STREET NW	TCO	beverly.hooks@dc.gov	Samsung Rugby 3	Beverly Hooks
2029077036	Certified as Active	Wireless Phone/Device	Cellular	AT&T Wireless	2000 14TH STREET NW	TCO	Ronetta.Davis@dc.gov	Samsung Rugby 3	Ronetta Davis
2029077039	Certified as Active	Wireless Phone/Device	Cellular	AT&T Wireless	2000 14TH STREET NW	TCO	kendra.watkins@dc.gov	Samsung Rugby 3	Kendra Watkins
2029077040	Certified as Active	Wireless Phone/Device	Cellular	AT&T Wireless	414 FARRAGUT STREET NE	TOA	ricardo.mckinney@dc.gov	Samsung Galaxy S5	Ricardo McKinney
2029077044	Certified as Active	Wireless Phone/Device	Cellular	AT&T Wireless	2000 14TH STREET NW	TCO	timothy.robinson@dc.gov	Samsung Rugby 3	Timothy Robinson
2029077051	Certified as Active	Wireless Phone/Device	Cellular	AT&T Wireless	2000 14TH STREET NW	SCG	marlene.dixon@dc.gov	Sonim Bolt SL	Edward Hall
2029077053	Certified as Active	Wireless Phone/Device	Cellular	AT&T Wireless	2000 14TH STREET NW	SCG	donna.butler@dc.gov	Samsung Rugby 3	Donna Butler
2029077067	Certified as Active	Wireless Phone/Device	Cellular	AT&T Wireless	2860 South Capitol STREET SE	PTSA	thomas.perry@dc.gov	Samsung Rugby Pro	Thomas Perry
2029077068	Certified as Active	Wireless Phone/Device	Cellular	AT&T Wireless	2000 14TH STREET NW	TOA/TCO	quintina.butler@dc.gov	Samsung Rugby 3	QUINTINA BUTLER
2029077077	Certified as Active	Wireless Phone/Device	Cellular	AT&T Wireless	2000 14TH STREET NW	TCO	joyce.chase@dc.gov	Samsung Rugby Pro	Joyce Chase
2029077078	Certified as Active	Wireless Phone/Device	Cellular	AT&T Wireless	2000 14TH STREET NW	SCG	dena.thweatt@dc.gov	IPhone 4s	Dena Thweatt
2029077079	Certified as Active	Wireless Phone/Device	Cellular	AT&T Wireless	2000 14TH STREET NW	TCO	David.Donaldson@dc.gov	Note 4	David Donaldson

Phone Number	STATUS	FUNCTION	SERVICE TYPE	VENDOR	SERVICE ADDRESS	ROOM	CONTACT	MODEL_NAME	CONTACT_NAME
2029077080	Certified as Active	Wireless Phone/Device	Cellular	AT&T Wireless	2000 14TH STREET NW	TOA/TCO	traffic.control@dc.gov	Samsung Rugby 3	ANGELINA GREEN
2029077082	Certified as Active	Wireless Phone/Device	Cellular	AT&T Wireless	55 M STREET SE	OITI	pamela.grier@dc.gov	iPhone 4s	pamela grier
2029077088	Certified as Active	Wireless Phone/Device	Cellular	AT&T Wireless	2000 14TH STREET NW	TOA/TCO	eric.ambrose@dc.gov	Samsung Rugby 3	Eric Ambrose
2029077092	Certified as Active	Wireless Phone/Device	Cellular	AT&T Wireless	2000 14TH STREET NW	SCG	mary.hillian@dc.gov	Samsung Rugby 3	Mary Hillian
2029077093	Certified as Active	Wireless Phone/Device	Cellular	AT&T Wireless	2000 14TH STREET NW	TOA/TCO	Shanika.Hailey@dc.gov	Samsung Rugby 3	Shanika Hailey
2029077097	Certified as Active	Wireless Phone/Device	Cellular	AT&T Wireless	2000 14TH STREET NW	TCO	carla.green@dc.gov	Samsung Rugby 3	Carla Green
2029077101	Certified as Active	Wireless Phone/Device	Cellular	AT&T Wireless	2000 14TH STREET NW	TCO	ethel.addison@dc.gov	Sonim Bolt SL	Ethel Addison
2029077104	Certified as Active	Wireless Phone/Device	Cellular	AT&T Wireless	2000 14TH STREET NW	TCO	deborah.morton@dc.gov	Samsung Rugby 3	Deborah Morton
2029077106	Certified as Active	Wireless Phone/Device	Cellular	AT&T Wireless	2000 14TH STREET NW	TCO	kevin.edwards@dc.gov	Samsung Rugby 3	Kevin Edwards
2029077108	Certified as Active	Wireless Phone/Device	Cellular	AT&T Wireless	55 M STREET SE	PPSA	Gilberto.Solano@dc.gov	Samsung Rugby 3	Gilberto Solano
2029077109	Certified as Active	Wireless Phone/Device	Cellular	AT&T Wireless	2000 14TH STREET NW	TCO	tyreese.bailey@dc.gov	Samsung Rugby 3	Tyreese Bailey
2029077110	Certified as Active	Wireless Phone/Device	Cellular	AT&T Wireless	2000 14TH STREET NW	TCO	Preston.Cato@dc.gov	Samsung Rugby 3	Preston Cato
2029077115	Certified as Active	Wireless Phone/Device	Cellular	AT&T Wireless	2000 14TH STREET NW	TCO	tywan.jones@dc.gov	Samsung Rugby 3	Tywan Jones
2029077117	Certified as Active	Wireless Phone/Device	Cellular	AT&T Wireless	2000 14TH STREET NW	SCG	Otis.Kashif@dc.gov	Note 4	Otis Kashif
2029077121	Certified as Active	Wireless Phone/Device	Cellular	AT&T Wireless	2000 14TH STREET NW	SCG	linda.chapman@dc.gov	Sonim Bolt SL	Linda Chapman
2029077122	Certified as Active	Wireless Phone/Device	Cellular	AT&T Wireless	2000 14TH STREET NW	SCG	crossing.guard@dc.gov	Samsung Rugby 3	Tracy Carter
2029077123	Certified as Active	Wireless Phone/Device	Cellular	AT&T Wireless	2000 14TH STREET NW	SCG	darlene.clark@dc.gov	Samsung Rugby 3	Darlene Clark
2029077124	Certified as Active	Wireless Phone/Device	Cellular	AT&T Wireless	2000 14TH STREET NW	SCG	kim.cook@dc.gov	Samsung Rugby 3	Kim Cook
2029077125	Certified as Active	Wireless Phone/Device	Cellular	AT&T Wireless	2000 14TH STREET NW	TOA/TCO	edward.lucas@dc.gov	Samsung Rugby 3	Edward Lucas
2029077127	Certified as Active	Wireless Phone/Device	Cellular	AT&T Wireless	414 FARRAGUT STREET NE	Snow Phone	melony.pree@dc.gov	Sonim XP1520	Snow #4 Phone
2029077128	Certified as Active	Wireless Phone/Device	Cellular	AT&T Wireless	2000 14TH STREET NW	SCG	crossing.guard@dc.gov	Samsung Rugby 3	Hardman Patricia
2029077129	Certified as Active	Wireless Phone/Device	Cellular	AT&T Wireless	1735 15TH STREET NE	Rope	Kevin.brooks@dc.gov	Samsung Rugby Pro	Kevin Brooks
2029077134	Certified as Active	Wireless Phone/Device	Cellular	AT&T Wireless	2000 14TH STREET NW	SCG	crossing.guard@dc.gov	Samsung Rugby Pro	Kimberley Ware
2029077136	Certified as Active	Wireless Phone/Device	Cellular	AT&T Wireless	2000 14TH STREET NW	SCG	chiquita.mills@dc.gov	Samsung Rugby 3	Chiquita Mills
2029077137	Certified as Active	Wireless Phone/Device	Cellular	AT&T Wireless	2000 14TH STREET NW	SCG	sharon.pyles@dc.gov	Samsung Rugby 3	Sharon Pyles
2029077138	Certified as Active	Wireless Phone/Device	Cellular	AT&T Wireless	55 M STREET SE	OITI	marlene.dixon@dc.gov	Samsung Rugby 3	Marlene Dixon
2029077139	Certified as Active	Wireless Phone/Device	Cellular	AT&T Wireless	2000 14TH STREET NW	SCG	mary.scott@dc.gov	Samsung Rugby 3	Mary Scott
2029077140	Certified as Active	Wireless Phone/Device	Cellular	AT&T Wireless	2000 14TH STREET NW	SCG	crossing.guard@dc.gov	Samsung Rugby Pro	Perry Melissa
2029077141	Certified as Active	Wireless Phone/Device	Cellular	AT&T Wireless	2000 14TH STREET NW	SCG	crossing.guard@dc.gov	Samsung Rugby 3	Monica Williams
2029077145	Certified as Active	Wireless Phone/Device	Cellular	AT&T Wireless	2000 14TH STREET NW	SCG	marie.brown@dc.gov	Samsung Rugby 3	Marie Brown
2029077146	Certified as Active	Wireless Phone/Device	Cellular	AT&T Wireless	2000 14TH STREET NW	SCG	shezzell.graham@dc.gov	Samsung Rugby 3	Shezzell Graham
2029077147	Certified as Active	Wireless Phone/Device	Cellular	AT&T Wireless	55 M STREET SE	SCG	Robert.Hargrove@dc.gov	Note 4	Robert Hargrove
2029077150	Certified as Active	Wireless Phone/Device	Cellular	AT&T Wireless	2000 14TH STREET NW	SCG	faye.wright@dc.gov	Samsung Rugby 3	Faye Wright
2029077151	Certified as Active	Wireless Phone/Device	Cellular	AT&T Wireless	55 M STREET SE	OITI	kathryn.morris-matthews@dc.gov	Samsung Rugby 3	Kathryn Morris-Matthews
2029077153	Certified as Active	Wireless Phone/Device	Cellular	AT&T Wireless	55 M STREET SE	OD	neville.daley@dc.gov	Samsung Rugby Pro	Neville Daley
2029077156	Certified as Active	Wireless Phone/Device	Cellular	AT&T Wireless	2000 14TH STREET NW	TCO	lucia.roat@dc.gov	Samsung Rugby 3	Lucia Roa
2029077157	Certified as Active	Wireless Phone/Device	Cellular	AT&T Wireless	2000 14TH STREET NW	SCG	robert.green3@dc.gov	Samsung Rugby Pro	Robert Green
2029077158	Certified as Active	Wireless Phone/Device	Cellular	AT&T Wireless	2000 14TH STREET NW	TCO/SCG	Kenneth.Mitchell@dc.gov	Sonim Bolt SL	Kenneth Mitchell
2029077159	Certified as Active	Wireless Phone/Device	Cellular	AT&T Wireless	1735 15TH STREET NE	Rope	Chief.Honesty-Bey@dc.gov	Samsung Rugby Pro	Chief Honesty-Bey
2029077162	Certified as Active	Wireless Phone/Device	Cellular	AT&T Wireless	2000 14TH STREET NW	SCG	patricia.david@dc.gov	Samsung Rugby 3	Patricia David
2029077164	Certified as Active	Wireless Phone/Device	Cellular	AT&T Wireless	2000 14TH STREET NW	TCO	john.lewis@dc.gov	Samsung Rugby 3	John Lewis
2029077166	Certified as Active	Wireless Phone/Device	Cellular	AT&T Wireless	2000 14TH STREET NW	SCG	lonnie.watson@dc.gov	Samsung Rugby 3	Lonnie Watson
2029077175	Certified as Active	Wireless Phone/Device	Cellular	AT&T Wireless	414 FARRAGUT STREET NE	Snow	melony.pree@dc.gov	Sonim XP1520	Snow #2 Phone
2029077187	Certified as Active	Wireless Phone/Device	Cellular	AT&T Wireless	2000 14TH STREET NW	SCG	antonio.morrob@dc.gov	Samsung Rugby 3	Antonio Morrob
2029077188	Certified as Active	Wireless Phone/Device	Cellular	AT&T Wireless	1100 4TH STREET SW	PSRA	Nancy.Wilson@dc.gov	Samsung S5	Nancy Willson
2029077189	Certified as Active	Wireless Phone/Device	Cellular	AT&T Wireless	2000 14TH STREET NW	SCG	annie.perry@dc.gov	Samsung Rugby 3	Annie Perry
2029077192	Certified as Active	Wireless Phone/Device	Cellular	AT&T Wireless	2000 14TH STREET NW	SCG	carolyn.smith@dc.gov	Samsung Rugby 3	Carolyn Smith
2029077194	Certified as Active	Wireless Phone/Device	Cellular	AT&T Wireless	55 M STREET SE	IPMA	konjit.eskender@dc.gov	Samsung Rugby Pro	Konjit Eskender
2029077195	Certified as Active	Wireless Phone/Device	Cellular	AT&T Wireless	2000 14TH STREET NW	SCG	mary.smith@dc.gov	Samsung Rugby 3	Mary Smith
2029077196	Certified as Active	Wireless Phone/Device	Cellular	AT&T Wireless	2000 14TH STREET NW	TCO	Charlotte.Nickelson@dc.gov	Sonim Bolt SL	Charlotte Nickelson
2029077197	Certified as Active	Wireless Phone/Device	Cellular	AT&T Wireless	1735 15TH STREET NE	Warehouse	Kimberly.baxter@dc.gov	Samsung Galaxy S5	kimberley baxter
2029077201	Certified as Active	Wireless Phone/Device	Cellular	AT&T Wireless	414 FARRAGUT STREET NE	SBM	charles.tenbrook@dc.gov	Samsung Rugby Pro	Charles Tenbrook
2029077202	Certified as Active	Wireless Phone/Device	Cellular	AT&T Wireless	55 M STREET SE	PPSA	aidin.sarabi@dc.gov	Samsung Rugby Pro	Aidin Sarabi
2029077203	Certified as Active	Wireless Phone/Device	Cellular	AT&T Wireless	2000 14TH STREET NW	SCG	felicia.allen@dc.gov	Samsung Rugby 3	Felicia Allen
2029077204	Certified as Active	Wireless Phone/Device	Cellular	AT&T Wireless	2000 14TH STREET NW	SCG	crossing.guard@dc.gov	Samsung Rugby 3	Shirley Anthony
2029077208	Certified as Active	Wireless Phone/Device	Cellular	AT&T Wireless	2000 14TH STREET NW	TCO	Tasha.Tolbert@dc.gov	Samsung Rugby Pro	Tasha Tolbert
2029077212	Certified as Active	Wireless Phone/Device	Cellular	AT&T Wireless	55 M STREET SE	PPSA	Sam.zimbabwe@dc.gov	Samsung Rugby Pro	Sam Zimbabwe

Phone Number	STATUS	FUNCTION	SERVICE TYPE	VENDOR	SERVICE ADDRESS	ROOM	CONTACT	MODEL_NAME	CONTACT_NAME
2029077213	Certified as Active	Wireless Phone/Device	Cellular	AT&T Wireless	1403 W STREET	UFA	lashawn.lindsey@dc.gov	Sonim Bolt SL	Lashawn Lindsey
2029077214	Certified as Active	Wireless Phone/Device	Cellular	AT&T Wireless	2000 14TH STREET NW	SCG	crossing.guard@dc.gov	Samsung Rugby 3	Melissa Perry-Thomas
2029077216	Certified as Active	Wireless Phone/Device	Cellular	AT&T Wireless	55 M STREET SE	OITI	Phyllis.Burnett@dc.gov	Samsung Galaxy S5	Phyllis Burnett
2029077218	Certified as Active	Wireless Phone/Device	Cellular	AT&T Wireless	2000 14TH STREET NW	SCG	crossing.guard@dc.gov	Samsung Rugby 3	Eric Thorpe
2029077219	Certified as Active	Wireless Phone/Device	Cellular	AT&T Wireless	2000 14TH STREET NW	SCG	jermain.patterson@dc.gov	Samsung Rugby 3	Jermain Patterson
2029077220	Certified as Active	Wireless Phone/Device	Cellular	AT&T Wireless	2000 14TH STREET NW	SCG	gina.porter@dc.gov	Samsung Rugby 3	Gina Porter
2029077221	Certified as Active	Wireless Phone/Device	Cellular	AT&T Wireless	2000 14TH STREET NW	SCG	crossing.guard@dc.gov	Samsung Rugby 3	nicole brennan
2029077224	Certified as Active	Wireless Phone/Device	Cellular	AT&T Wireless	1100 4TH STREET SW	PSRA	Tiffany.Tenbrook@dc.gov	Samsung Rugby Pro	Tiffany Tenbrook
2029077225	Certified as Active	Wireless Phone/Device	Cellular	AT&T Wireless	2000 14TH STREET NW	SCG	crossing.guard@dc.gov	Samsung Rugby 3	Smith Mary
2029077234	Certified as Active	Wireless Phone/Device	Cellular	AT&T Wireless	55 M STREET SE	ASA	London.Hollway@dc.gov	Samsung Galaxy S5	London Hollway
2029077236	Certified as Active	Wireless Phone/Device	Cellular	AT&T Wireless	2000 14TH STREET NW	ROPE	alvin.durham@dc.gov	Samsung Rugby 3	Alvin Durham
2029077237	Certified as Active	Wireless Phone/Device	Cellular	AT&T Wireless	2000 14TH STREET NW	SCG	stephanie.durant@dc.gov	Samsung Rugby 3	Stephanie Durant
2029077238	Certified as Active	Wireless Phone/Device	Cellular	AT&T Wireless	1338 G STREET SE	G ST	valorie.wiggins@dc.gov	Samsung Rugby Pro	Delilah Saunders
2029077240	Certified as Active	Wireless Phone/Device	Cellular	AT&T Wireless	2000 14TH STREET NW	SCG	darlene.hinson@dc.gov	Samsung Rugby 3	Darlene Hinson
2029077242	Certified as Active	Wireless Phone/Device	Cellular	AT&T Wireless	1403 W STREET	SBM	jeff.baxter@dc.gov	Samsung Rugby 3	jeff baxter
2029077243	Certified as Active	Wireless Phone/Device	Cellular	AT&T Wireless	2000 14TH STREET NW	SCG	crossing.guard@dc.gov	Samsung Rugby 3	Deirdre Humes
2029077246	Certified as Active	Wireless Phone/Device	Cellular	AT&T Wireless	2000 14TH STREET NW	TOA/SCG	Kendra.Ambrose@dc.gov	Samsung Rugby Pro	Kendra Ambrose
2029077248	Certified as Active	Wireless Phone/Device	Cellular	AT&T Wireless	2000 14TH STREET NW	SCG	latarsha.middleton@dc.gov	Samsung Rugby 3	Latarsha Middleton
2029077249	Certified as Active	Wireless Phone/Device	Cellular	AT&T Wireless	55 M STREET SE	Snow Phone	emily.dalphy@dc.gov	IPhone 4s	Emily Daphy
2029077250	Certified as Active	Wireless Phone/Device	Cellular	AT&T Wireless	55 M STREET SE	Chief of Staff	William.Hwang@dc.gov	iphone 6	William Hwang
2029077253	Certified as Active	Wireless Phone/Device	Cellular	AT&T Wireless	2000 14TH STREET NW	SCG	crystal.powell@dc.gov	Samsung Rugby 3	Crystal Powell
2029077254	Certified as Active	Wireless Phone/Device	Cellular	AT&T Wireless	2000 14TH STREET NW	SCG	crossing.guard@dc.gov	Samsung Rugby 3	Yugenia Rogers
2029077255	Certified as Active	Wireless Phone/Device	Cellular	AT&T Wireless	55 M STREET SE	PTSA	Paul.Revesz@dc.gov	Samsung Rugby Pro	Paul Revesz
2029077257	Certified as Active	Wireless Phone/Device	Cellular	AT&T Wireless	2000 14TH STREET NW	SCG	cheryl.gibson@dc.gov	Samsung Rugby 3	Cheryl Gibson
2029077260	Certified as Active	Wireless Phone/Device	Cellular	AT&T Wireless	2000 14TH STREET NW	SCG	louise.davis@dc.gov	Samsung Rugby 3	Louise Davis
2029077262	Certified as Active	Wireless Phone/Device	Cellular	AT&T Wireless	2000 14TH STREET NW	TOA/TCO	cierra.craig@dc.gov	Samsung Rugby 3	Cierra Craig
2029077263	Certified as Active	Wireless Phone/Device	Cellular	AT&T Wireless	2000 14TH STREET NW	SCG	crossing.guard@dc.gov	Samsung S5	Sharon Dunbar-Franks
2029077264	Certified as Active	Wireless Phone/Device	Cellular	AT&T Wireless	2000 14TH STREET NW	SCG	claudia.alvin@dc.gov	Samsung Rugby 3	Claudia Alvin
2029077267	Certified as Active	Wireless Phone/Device	Cellular	AT&T Wireless	414 FARRAGUT STREET NE	Snow Phone	angela.pettus@dc.gov	Sonim XP1520	Snow #3 Phone
2029077273	Certified as Active	Wireless Phone/Device	Cellular	AT&T Wireless	1403 W STREET	TOA	Paulette.Tinner@dc.gov	Sonim Bolt SL	Paulette Tinner
2029077274	Certified as Active	Wireless Phone/Device	Cellular	AT&T Wireless	2000 14TH STREET NW	SCG	thomasine.garvin@dc.gov	Samsung Rugby 3	Thomasine Garvin
2029077275	Certified as Active	Wireless Phone/Device	Cellular	AT&T Wireless	2000 14TH STREET NW	SCG	Shirley.Howe@dc.gov	Samsung Rugby 3	Shirley Howe
2029077276	Certified as Active	Wireless Phone/Device	Cellular	AT&T Wireless	2000 14TH STREET NW	SCG	darlene.jones@dc.gov	Samsung Rugby 3	Darlene Jones
2029077277	Certified as Active	Wireless Phone/Device	Cellular	AT&T Wireless	2000 14TH STREET NW	SCG	thomas.benefield@dc.gov	Samsung Rugby 3	Thomas Benefield
2029077280	Certified as Active	Wireless Phone/Device	Cellular	AT&T Wireless	2000 14TH STREET NW	SCG	reacie.lindsay@dc.gov	Samsung Rugby 3	Reacie Lindsay
2029077286	Certified as Active	Wireless Phone/Device	Cellular	AT&T Wireless	2000 14TH STREET NW	SCG	mattie.redd@dc.gov	Samsung Rugby 3	Mattie Redd
2029077293	Certified as Active	Wireless Phone/Device	Cellular	AT&T Wireless	2000 14TH STREET NW	SCG	Sharion.Larry@dc.gov	Sonim Bolt SL	Sharion Larry
2029077294	Certified as Active	Wireless Phone/Device	Cellular	AT&T Wireless	55 M STREET SE	Leap	Ayana.smith@dc.gov	Samsung Galaxy S5	Ayana Smith
2029077297	Certified as Active	Wireless Phone/Device	Cellular	AT&T Wireless	2000 14TH STREET NW	SCG	crossing.guard@dc.gov	Samsung Rugby 3	Raynette Rhodes
2029077306	Certified as Active	Wireless Phone/Device	Cellular	AT&T Wireless	2000 14TH STREET NW	SCG	crossing.guard@dc.gov	Samsung Rugby 3	Tameka Davis
2029077313	Certified as Active	Wireless Phone/Device	Cellular	AT&T Wireless	55 M STREET SE	TOA	James.royal@dc.gov	Samsung Rugby Pro	James Royal
2029077315	Certified as Active	Wireless Phone/Device	Cellular	AT&T Wireless	2000 14TH STREET NW	SCG	anna.atkinson@dc.gov	Samsung Rugby 3	Anna Atkinson
2029077323	Certified as Active	Wireless Phone/Device	Cellular	AT&T Wireless	2000 14TH STREET NW	SCG	crossing.guard@dc.gov	Samsung Rugby 3	Joanne Brinkley
2029077325	Certified as Active	Wireless Phone/Device	Cellular	AT&T Wireless	2000 14TH STREET NW	SCG	eula.brinson@dc.gov	Samsung Rugby 3	Eula Brinson
2029077326	Certified as Active	Wireless Phone/Device	Cellular	AT&T Wireless	2000 14TH STREET NW	SCG	cynthia.clark@dc.gov	Samsung Rugby 3	Cynthia Clark
2029077328	Certified as Active	Wireless Phone/Device	Cellular	AT&T Wireless	2000 14TH STREET NW	SCG	delores.clark@dc.gov	Samsung Rugby 3	Delores Clark
2029077334	Certified as Active	Wireless Phone/Device	Cellular	AT&T Wireless	2000 14TH STREET NW	SCG	edwina.gray@dc.gov	Samsung Rugby 3	Edwina Gray
2029077335	Certified as Active	Wireless Phone/Device	Cellular	AT&T Wireless	2000 14TH STREET NW	SCG	Edward.Robinson@dc.gov	Samsung S5	Edward Robinson
2029077337	Certified as Active	Wireless Phone/Device	Cellular	AT&T Wireless	55 M STREET SE	Communications	barry.saunders@dc.gov	Samsung S5	Barry Saunders
2029077341	Certified as Active	Wireless Phone/Device	Cellular	AT&T Wireless	2000 14TH STREET NW	SCG	arletta.williams@dc.gov	Samsung Rugby 3	Arletta Williams
2029077347	Certified as Active	Wireless Phone/Device	Cellular	AT&T Wireless	2000 14TH STREET NW	SCG	annette.lucas@dc.gov	Samsung Rugby 3	Annette Lucas
2029077352	Certified as Active	Wireless Phone/Device	Cellular	AT&T Wireless	1735 15TH STREET NE	Rope	Albert.makle@dc.gov	Samsung Rugby Pro	Albert Makle
2029077354	Certified as Active	Wireless Phone/Device	Cellular	AT&T Wireless	2000 14TH STREET NW	SCG	Victor.Brown@dc.gov	Note 4	Victor Brown
2029077359	Certified as Active	Wireless Phone/Device	Cellular	AT&T Wireless	2000 14TH STREET NW	SCG	delva.dandridge@dc.gov	Samsung Rugby 3	Delva Dandridge
2029077379	Certified as Active	Wireless Phone/Device	Cellular	AT&T Wireless	55 M STREET SE	DDOT	jamel.el-hamri@dc.gov	Samsung Rugby 3	Jamel El-Hamri
2029079317	Certified as Active	Wireless Phone/Device	Cellular	AT&T Wireless	2000 14TH STREET NW	IPS	hung_cuong.nguyen@dc.gov	Samsung S5	Hung_Cuong Cuong
2029079430	Certified as Active	Wireless Phone/Device	Cellular	AT&T Wireless	55 M STREET SE	UFA	michaud.gray@dc.gov	Samsung Rugby 3	Michaud Gray

Phone Number	STATUS	FUNCTION	SERVICE TYPE	VENDOR	SERVICE ADDRESS	ROOM	CONTACT	MODEL_NAME	CONTACT_NAME
2405088067	Certified as Active	Wireless Phone/Device	Cellular	AT&T Wireless	55 M STREET SE	TOA	brenda.kenney@dc.gov	Samsung S5	brenda kenney

Phone Number	STATUS	FUNCTIO	SERVICE	VENDOR	SERVICE	ROOM	CONTACT	MODEL_N	CONTACT
2022809241	Certified as Active	Wireless Phone/Device	Cellular	VERIZON WIRELESS	55 M STREET SE	OITI	christopher.faust@dc.gov	IPad Air 32GB	Christopher Faust
2023021230	Certified as Active	Wireless Phone/Device	Cellular	VERIZON WIRELESS	55 M STREET SE	OITI	jose.colon@dc.gov	Samsung - galaxy 4s	Circulator Program
2023022857	Certified as Active	Wireless Phone/Device	Cellular	VERIZON WIRELESS	55 M STREET SE				
2023026892	Certified as Active	Wireless Phone/Device	Cellular	VERIZON WIRELESS	55 M STREET SE	IPMA	Emnete.Banko@dc.gov	Iphone 5s	Emnete Banko
2023060638	Certified as Active	Wireless Phone/Device	Cellular	VERIZON WIRELESS	55 M STREET SE	OITI	jose.colon@dc.gov	Samsung - galaxy 4s	Circulator Program
2023062138	Certified as Active	Wireless Phone/Device	Cellular	VERIZON WIRELESS	55 M STREET SE	PSRA	gary.blunt@dc.gov	Samsung Galaxy Tab 10.1 4GLTE	Gary Blunt
2023063370	Certified as Active	Wireless Phone/Device	Cellular	VERIZON WIRELESS	55 M STREET SE	OITI	jose.colon@dc.gov	Samsung - galaxy 4s	Circulator Program
2023068524	Certified as Active	Wireless Phone/Device	Cellular	VERIZON WIRELESS	55 M STREET SE	OITI	jose.colon@dc.gov	Samsung - galaxy 4s	Circulator Program
2023092733	Certified as Active	Wireless Phone/Device	Cellular	VERIZON WIRELESS	55 M STREET SE	PSRA	david.wells@dc.gov	Samsung Galaxy Tab 10.1 4GLTE	David Wells
2023093491	Certified as Active	Wireless Phone/Device	Cellular	VERIZON WIRELESS	55 M STREET SE	PSRA	doris.shaw@dc.gov	Samsung Galaxy Tab 10.1 4GLTE	Doris Shaw
2023093587	Certified as Active	Wireless Phone/Device	Cellular	VERIZON WIRELESS	55 M STREET SE	OITI	jose.colon@dc.gov	Samsung - galaxy 4s	Circulator Program
2023095882	Certified as Active	Wireless Phone/Device	Cellular	VERIZON WIRELESS	55 M STREET SE	UFA	taryn.farber@dc.gov	Dell Venue	Taryn Farber
2023096256	Certified as Active	Wireless Phone/Device	Cellular	VERIZON WIRELESS	55 M STREET SE	UFA	evan.anderson@dc.gov	Dell Venue	Evan Anderson
2023097389	Certified as Active	Wireless Phone/Device	Cellular	VERIZON WIRELESS	55 M STREET SE	OITI	jose.colon@dc.gov	Samsung - galaxy 4s	Circulator Program
2023590049	Certified as Active	Wireless Phone/Device	Cellular	VERIZON WIRELESS	55 M STREET SE	IPMA	mg.habib@dc.gov	Samsung Galaxy S5	MG Habib
2023590136	Certified as Active	Wireless Phone/Device	Cellular	VERIZON WIRELESS	55 M STREET SE				

Phone Number	STATUS	FUNCTIO	SERVICE	VENDOR	SERVICE	ROOM	CONTACT	MODEL_N	CONTACT
2023590248	Certified as Active	Wireless Phone/Device	Cellular	VERIZON WIRELESS	55 M STREET SE	DDOT Director	regina.barnes@dc.gov	iphone 6S	Leif Dormsjo
2023590400	Certified as Active	Wireless Phone/Device	Cellular	VERIZON WIRELESS	55 M STREET SE	OITI	Joel.Price@dc.gov	Blackberry 9930	Joel Price
2023590460	Certified as Active	Wireless Phone/Device	Cellular	VERIZON WIRELESS	55 M STREET SE				
2023590463	Certified as Active	Wireless Phone/Device	Cellular	VERIZON WIRELESS	55 M STREET SE				
2023590479	Certified as Active	Wireless Phone/Device	Cellular	VERIZON WIRELESS	55 M STREET SE				
2023590491	Certified as Active	Wireless Phone/Device	Cellular	VERIZON WIRELESS	55 M STREET SE	Contract	Wanda.Lawrence@dc.gov	blackberry TOUR	Wanda Lawrence
2023590688	Certified as Active	Wireless Phone/Device	Cellular	VERIZON WIRELESS	55 M STREET SE	OITI	jose.colon@dc.gov	Samsung - galaxy 4s	Circulator Program
2023590699	Certified as Active	Wireless Phone/Device	Cellular	VERIZON WIRELESS	55 M STREET SE	Frank Seales Of	Kenneth.higgins@dc.gov	BLCKBERRY CURVE 8330	Ken Higgins
2023590782	Certified as Active	Wireless Phone/Device	Cellular	VERIZON WIRELESS	55 M STREET SE				
2023590785	Certified as Active	Wireless Phone/Device	Cellular	VERIZON WIRELESS	55 M STREET SE				
2023595485	Certified as Active	Wireless Phone/Device	Cellular	VERIZON WIRELESS	55 M STREET SE				
2023595631	Certified as Active	Wireless Phone/Device	Cellular	VERIZON WIRELESS	55 M STREET SE				
2023596948	Certified as Active	Wireless Phone/Device	Cellular	VERIZON WIRELESS	55 M STREET SE	IPMA	ravindra.ganvir@dc.gov	Iphone 4s	Ravindra Ganvir
2023651830	Certified as Active	Wireless Phone/Device	Cellular	VERIZON WIRELESS	55 M STREET SE	OITI	elizabeth.lamont@dc.gov	Jetpack Mifi 6620L	spare Mifi
2023655665	Certified as Active	Wireless Phone/Device	Cellular	VERIZON WIRELESS	55 M STREET SE	OITI	othman.chebli@dc.gov	IPad Air 32GB	Othman Chebli
2023798826	Certified as Active	Wireless Phone/Device	Cellular	VERIZON WIRELESS	55 M STREET SE	HR	tanya.powell@dc.gov	jetpack-verizonwireless	Tanya Powell

Phone Number	STATUS	FUNCTIO	SERVICE	VENDOR	SERVICE	ROOM	CONTACT	MODEL_N	CONTACT
2023805635	Certified as Active	Wireless Phone/Device	Cellular	VERIZON WIRELESS	55 M STREET SE	OITI	jose.colon@dc.gov	V620	Circulator Program
2024231124	Certified as Active	Wireless Phone/Device	Cellular	VERIZON WIRELESS	55 M STREET SE	OCFO	katherine.valentine@dc.gov	IPad Air 32GB	Katherine Valentine
2024233734	Certified as Active	Wireless Phone/Device	Cellular	VERIZON WIRELESS	1100 4TH STREET SW	Permits	talat.benson@dc.gov	Samsung Galaxy S 5	Talat Benson
2024236099	Certified as Active	Wireless Phone/Device	Cellular	VERIZON WIRELESS	1100 4TH STREET SW	PSOP	malinda.anderson@dc.gov	Samsung Galaxy S5	Malinda Anderson
2024236211	Certified as Active	Wireless Phone/Device	Cellular	VERIZON WIRELESS	55 M STREET SE	OITI	jose.colon@dc.gov	Samsung - galaxy 4s	Circulator Program
2024236263	Certified as Active	Wireless Phone/Device	Cellular	VERIZON WIRELESS	55 M STREET SE	HR	sandra.perry@dc.gov	iPhone 5S 16GB	Sandra Perry
2024236312	Certified as Active	Wireless Phone/Device	Cellular	VERIZON WIRELESS	55 M STREET SE	OD	Kenneth.Chandler@dc.gov	iphone 6	Kenneth Chandler
2024236888	Certified as Active	Wireless Phone/Device	Cellular	VERIZON WIRELESS	55 M STREET SE	OITI	jose.colon@dc.gov	Samsung - galaxy 4s	Circulator Program
2024371206	Certified as Active	Wireless Phone/Device	Cellular	VERIZON WIRELESS	55 M STREET SE	OD	aaron.rhones@dc.gov	iphone 6 plus	Aaron Rhones
2024500938	Certified as Active	Wireless Phone/Device	Cellular	VERIZON WIRELESS	55 M STREET SE	TOA	sandeep.bhatia@dc.gov	Dell Venue	Sandeep Bhatia
2024656112	Certified as Active	Wireless Phone/Device	Cellular	VERIZON WIRELESS	55 M STREET SE	PTSA	klara.baryshev@dc.gov	Droid	Klara Baryshev
2024656317	Certified as Active	Wireless Phone/Device	Cellular	VERIZON WIRELESS	55 M STREET SE	OITI	Amanda.ware@dc.gov	Droid	Amanda Harvey
2024865689	Certified as Active	Wireless Phone/Device	Cellular	VERIZON WIRELESS	55 M STREET SE	IPMA	clarence.dickerson@dc.gov	Samsung Galaxy S5	Trey Dickerson
2024970104	Certified as Active	Wireless Phone/Device	Cellular	VERIZON WIRELESS	55 M STREET SE	OITI	jose.colon@dc.gov	Samsung - galaxy 4s	Circulator Program
2024973735	Certified as Active	Wireless Phone/Device	Cellular	VERIZON WIRELESS	55 M STREET SE	OD	jose.colon@dc.gov	Samsung - galaxy 4s	Circulator Program
2025072505	Certified as Active	Wireless Phone/Device	Cellular	VERIZON WIRELESS	55 M STREET SE	UFA	ranjit.babra@dc.gov	iphone 6S	ranjit babra

Phone Number	STATUS	FUNCTIO	SERVICE	VENDOR	SERVICE	ROOM	CONTACT	MODEL_N	CONTACT
2025073422	Certified as Active	Wireless Phone/Device	Cellular	VERIZON WIRELESS	55 M STREET SE	UFA	munevver.ertem@dc.gov	iphone 6S	Munevver Ertem
2025073872	Certified as Active	Wireless Phone/Device	Cellular	VERIZON WIRELESS	55 M STREET SE	UFA	William.heist@dc.gov	iphone 6	william heist
2025073903	Certified as Active	Wireless Phone/Device	Cellular	VERIZON WIRELESS	55 M STREET SE	UFA	carlson.klapthor@dc.gov	iphone 6S	Carlson Klapthor
2025273611	Certified as Active	Wireless Phone/Device	Cellular	VERIZON WIRELESS	55 M STREET SE	UFA	duff.mccully@dc.gov	iphone 6S	robert mccully
2025274011	Certified as Active	Wireless Phone/Device	Cellular	VERIZON WIRELESS	55 M STREET SE	UFA	robert.corletta@dc.gov	iphone 6S	robert corletta
2025274149	Certified as Active	Wireless Phone/Device	Cellular	VERIZON WIRELESS	55 M STREET SE	UFA	Michael.chuko@dc.gov	iphone 6S	Mike Chuko
2025274496	Certified as Active	Wireless Phone/Device	Cellular	VERIZON WIRELESS	55 M STREET SE	UFA	jack.chapman@dc.gov	iphone 6S	Jack Chapman
2025274955	Certified as Active	Wireless Phone/Device	Cellular	VERIZON WIRELESS	55 M STREET SE	OITI	marlene.dixon@dc.gov	lphone 4s	Spare Phone
2025275633	Certified as Active	Wireless Phone/Device	Cellular	VERIZON WIRELESS	55 M STREET SE	UFA	John.ONeil@dc.gov	iphone 6S	John Oneil
2025275741	Certified as Active	Wireless Phone/Device	Cellular	VERIZON WIRELESS	55 M STREET SE	UFA	Steve.Mckindley-Ward@dc.gov	iphone 6S	Steve Mckindley-Ward
2025275802	Certified as Active	Wireless Phone/Device	Cellular	VERIZON WIRELESS	55 M STREET SE	OITI	jose.colon@dc.gov	Samsung - galaxy 4s	Circulator Program
2025275815	Certified as Active	Wireless Phone/Device	Cellular	VERIZON WIRELESS	55 M STREET SE	UFA	joseph.burckle@dc.gov	iphone 6S	Joseph Burckle
2025366776	Certified as Active	Wireless Phone/Device	Cellular	VERIZON WIRELESS	55 M STREET SE	OITI	jose.colon@dc.gov	mifi 4510L	Circulator Program
2025366972	Certified as Active	Wireless Phone/Device	Cellular	VERIZON WIRELESS	55 M STREET SE	OITI	jose.colon@dc.gov	Samsung - galaxy 4s	Circulator Program
2025538260	Certified as Active	Wireless Phone/Device	Cellular	VERIZON WIRELESS	55 M STREET SE	OITI	Elizabeth.lamont@dc.gov	Samsung Galaxy S6	elizabeth lamont
2025538320	Certified as Active	Wireless Phone/Device	Cellular	VERIZON WIRELESS	55 M STREET SE	OITI	diana.jordan@dc.gov	iphone 6	Diana Jordan

Phone Number	STATUS	FUNCTIO	SERVICE	VENDOR	SERVICE	ROOM	CONTACT	MODEL_N	CONTACT
2025574118	Certified as Active	Wireless Phone/Device	Cellular	VERIZON WIRELESS	55 M STREET SE	UFA	Joel.conlon@dc.gov	iphone 6S	Joel Conlon
2025574122	Certified as Active	Wireless Phone/Device	Cellular	VERIZON WIRELESS	55 M STREET SE	OITI	jose.colon@dc.gov	Samsung - galaxy 4s	Circulator Program
2025574590	Certified as Active	Wireless Phone/Device	Cellular	VERIZON WIRELESS	55 M STREET SE	UFA	Simoun.banua@dc.gov	iphone 6S	Simoun Banua
2025574646	Certified as Active	Wireless Phone/Device	Cellular	VERIZON WIRELESS	55 M STREET SE	UFA	janet.miller@dc.gov	iphone 6S	Janet Miller
2025575081	Certified as Active	Wireless Phone/Device	Cellular	VERIZON WIRELESS	55 M STREET SE	OITI	jose.colon@dc.gov	Samsung - galaxy 4s	Circulator Program
2025578316	Certified as Active	Wireless Phone/Device	Cellular	VERIZON WIRELESS	55 M STREET SE	TOA	Wasim.Raja@dc.gov	IPad Air 32GB	Wasim Raja
2025680024	Certified as Active	Wireless Phone/Device	Cellular	VERIZON WIRELESS	55 M STREET SE	OITI	marlene.dixon@dc.gov	Samsung Galaxy Tab 10.1 4GLTE	Spare Number
2025701519	Certified as Active	Wireless Phone/Device	Cellular	VERIZON WIRELESS	55 M STREET SE	OITI	elizabeth.lamont@dc.gov	jetpack-verizonwireless	Circulator Program
2025785018	Certified as Active	Wireless Phone/Device	Cellular	VERIZON WIRELESS	55 M STREET SE	Director IPad	regina.barnes@dc.gov	IPad Air 32GB	Directors Ipad
2025786236	Certified as Active	Wireless Phone/Device	Cellular	VERIZON WIRELESS	1100 4TH STREET SW	PSRA	walter.graham@dc.gov	IPAD Air 2	Walter Graham
2026034550	Certified as Active	Wireless Phone/Device	Cellular	VERIZON WIRELESS	55 M STREET SE	HR	ramono.flowers@dc.gov	iphone 5	Ramono Flowers
2026034868	Certified as Active	Wireless Phone/Device	Cellular	VERIZON WIRELESS	55 M STREET SE	OITI	jose.colon@dc.gov	Samsung - galaxy 4s	Circulator Program
2026572630	Certified as Active	Wireless Phone/Device	Cellular	VERIZON WIRELESS	55 M STREET SE	OITI	jose.colon@dc.gov	Samsung Galaxy Note	Circulator Program
2026791486	Certified as Active	Wireless Phone/Device	Cellular	VERIZON WIRELESS	55 M STREET SE	UFA	shaun.mckim@dc.gov	iphone 6	Shaun Mckim
2026791787	Certified as Active	Wireless Phone/Device	Cellular	VERIZON WIRELESS	55 M STREET SE	UFA	daniel.just@dc.gov	Samsung Galaxy S5	Daniel Just
2026955653	Certified as Active	Wireless Phone/Device	Cellular	VERIZON WIRELESS	55 M STREET SE	OITI	jose.colon@dc.gov	Samsung - galaxy 4s	Circulator Program

Phone Number	STATUS	FUNCTIO	SERVICE	VENDOR	SERVICE	ROOM	CONTACT	MODEL_N	CONTACT
2026955660	Certified as Active	Wireless Phone/Device	Cellular	VERIZON WIRELESS	55 M STREET SE	OITI	Marlene.dixon@dc.gov	BB Bold 9930	Test Project
2026955664	Certified as Active	Wireless Phone/Device	Cellular	VERIZON WIRELESS	55 M STREET SE	OITI	jose.colon@dc.gov	Samsung - galaxy 4s	Circulator Program
2026955680	Certified as Active	Wireless Phone/Device	Cellular	VERIZON WIRELESS	55 M STREET SE	OITI	Marlene.dixon@dc.gov	BB Bold 9930	Test Project
2026955687	Certified as Active	Wireless Phone/Device	Cellular	VERIZON WIRELESS	55 M STREET SE	OITI	jose.colon@dc.gov	Samsung - galaxy 4s	Circulator Program
2027318668	Certified as Active	Wireless Phone/Device	Cellular	VERIZON WIRELESS	55 M STREET SE	OITI	jose.colon@dc.gov	Samsung Galaxy S5	Circulator Pogram
2027318733	Certified as Active	Wireless Phone/Device	Cellular	VERIZON WIRELESS	55 M STREET SE	OD	dorinda.floyd@dc.gov	Dell Venue	Dorinda Floyd
2027319142	Certified as Active	Wireless Phone/Device	Cellular	VERIZON WIRELESS	55 M STREET SE	OITI	jose.colon@dc.gov	Samsung Galaxy S5	Circulator Program
2027446267	Certified as Active	Wireless Phone/Device	Cellular	VERIZON WIRELESS	55 M STREET SE	OITI	rodney.sutton@dc.gov	Samsung Galaxy S5	Rodney Sutton
2027540834	Certified as Active	Wireless Phone/Device	Cellular	VERIZON WIRELESS	55 M STREET SE	Street Car	jose.colon@dc.gov	Samsung Galaxy S5	Circulator Program
2027540876	Certified as Active	Wireless Phone/Device	Cellular	VERIZON WIRELESS	55 M STREET SE	OITI	marlene.dixon@dc.gov	Samsung Galaxy S5	Under Invesigation
2027541209	Certified as Active	Wireless Phone/Device	Cellular	VERIZON WIRELESS	55 M STREET SE	OITI	jose.colon@dc.gov	Samsung Galaxy S5	Circulator Program
2027541268	Certified as Active	Wireless Phone/Device	Cellular	VERIZON WIRELESS	55 M STREET SE	Circulator Prog	jose.colon@dc.gov	Samsung Galaxy S5	Circulator Program
2027541316	Certified as Active	Wireless Phone/Device	Cellular	VERIZON WIRELESS	55 M STREET SE	OITI	jose.colon@dc.gov	Samsung Galaxy S5	Circulator Program
2027541754	Certified as Active	Wireless Phone/Device	Cellular	VERIZON WIRELESS	55 M STREET SE	OITI	jose.colon@dc.gov	Samsung Galaxy S5	Circulator Program
2027541788	Certified as Active	Wireless Phone/Device	Cellular	VERIZON WIRELESS	55 M STREET SE	OITI	jose.colon@dc.gov	Samsung Galaxy S5	Circulator Program
2027541941	Certified as Active	Wireless Phone/Device	Cellular	VERIZON WIRELESS	55 M STREET SE	OITI	jose.colon@dc.gov	Samsung Galaxy S5	Circulator Program
2027542046	Certified as Active	Wireless Phone/Device	Cellular	VERIZON WIRELESS	55 M STREET SE	OITI	jose.colon@dc.gov	Samsung Galaxy S5	Circulator Program

Phone Number	STATUS	FUNCTIO	SERVICE	VENDOR	SERVICE	ROOM	CONTACT	MODEL_N	CONTACT
2027542056	Certified as Active	Wireless Phone/Device	Cellular	VERIZON WIRELESS	55 M STREET SE	OITI	jose.colon@dc.gov	Samsung Galaxy S5	Circulator Program
2027542237	Certified as Active	Wireless Phone/Device	Cellular	VERIZON WIRELESS	55 M STREET SE	OITI	jose.colon@dc.gov	Samsung Galaxy S5	Circulator Program
2027542342	Certified as Active	Wireless Phone/Device	Cellular	VERIZON WIRELESS	55 M STREET SE	OITI	jose.colon@dc.gov	Samsung Galaxy S5	Circulator Program
2027542641	Certified as Active	Wireless Phone/Device	Cellular	VERIZON WIRELESS	55 M STREET SE	OITI	jose.colon@dc.gov	Samsung Galaxy S5	Circulator Program
2027542818	Certified as Active	Wireless Phone/Device	Cellular	VERIZON WIRELESS	55 M STREET SE	OITI	jose.colon@dc.gov	Samsung Galaxy S5	Circulator Program
2027638195	Certified as Active	Wireless Phone/Device	Cellular	VERIZON WIRELESS	55 M STREET SE	OD	adrea.turner@dc.gov	iphone 6	Adrea Turner
2027638198	Certified as Active	Wireless Phone/Device	Cellular	VERIZON WIRELESS	55 M STREET SE	PTSA	derek.jones@dc.gov	iphone 6	Derek Jones
2027638405	Certified as Active	Wireless Phone/Device	Cellular	VERIZON WIRELESS	55 M STREET SE	OITI	Dorinda.Floyd@dc.gov	iphone 6	Dorinda Floyd
2027638635	Certified as Active	Wireless Phone/Device	Cellular	VERIZON WIRELESS	55 M STREET SE	OITI	terry.owens@dc.gov	iphone 6	Terry Owens
2027638654	Certified as Active	Wireless Phone/Device	Cellular	VERIZON WIRELESS	55 M STREET SE	OITI	Suzette.Robinson@dc.gov	iphone 6	Suzette Robinson
2028153367	Certified as Active	Wireless Phone/Device	Cellular	VERIZON WIRELESS	55 M STREET SE	OITI	jose.colon@dc.gov	Samsung Galaxy S5	Circulator Program
2028154221	Certified as Active	Wireless Phone/Device	Cellular	VERIZON WIRELESS	55 M STREET SE	OITI	jose.colon@dc.gov	Samsung Galaxy S5	Circulator Program
2028155863	Certified as Active	Wireless Phone/Device	Cellular	VERIZON WIRELESS	55 M STREET SE				
2028156879	Certified as Active	Wireless Phone/Device	Cellular	VERIZON WIRELESS	55 M STREET SE	OD	jose.colon@dc.gov	Samsung Galaxy S5	Jose Colon
2028156954	Certified as Active	Wireless Phone/Device	Cellular	VERIZON WIRELESS	55 M STREET SE	OD	jose.colon@dc.gov	Samsung Galaxy S5	Jose Colon
2028156957	Certified as Active	Wireless Phone/Device	Cellular	VERIZON WIRELESS	55 M STREET SE	OITI	jose.colon@dc.gov	Samsung Galaxy S5	Circulator Program

Phone Number	STATUS	FUNCTIO	SERVICE	VENDOR	SERVICE	ROOM	CONTACT	MODEL_N	CONTACT
2028157012	Certified as Active	Wireless Phone/Device	Cellular	VERIZON WIRELESS	55 M STREET SE	OD	jose.colon@dc.gov	Samsung Galaxy S5	Jose Colon
2028157100	Certified as Active	Wireless Phone/Device	Cellular	VERIZON WIRELESS	55 M STREET SE	TOA	jose.colon@dc.gov	Samsung Galaxy S5	Jose Colon
2028157102	Certified as Active	Wireless Phone/Device	Cellular	VERIZON WIRELESS	55 M STREET SE	OITI	jose.colon@dc.gov	Samsung Galaxy S5	Circulator Prgram
2028157104	Certified as Active	Wireless Phone/Device	Cellular	VERIZON WIRELESS	55 M STREET SE	OITI	jose.colon@dc.gov	Samsung Galaxy S5	Circulator Program
2028157120	Certified as Active	Wireless Phone/Device	Cellular	VERIZON WIRELESS	55 M STREET SE	OITI	jose.colon@dc.gov	Samsung Galaxy S5	Ciculator Program
2028157130	Certified as Active	Wireless Phone/Device	Cellular	VERIZON WIRELESS	55 M STREET SE	OD	jose.colon@dc.gov	Samsung Galaxy S5	Jose Colon
2028157236	Certified as Active	Wireless Phone/Device	Cellular	VERIZON WIRELESS	55 M STREET SE	OITI	jose.colon@dc.gov	Samsung Galaxy S5	Jose Colon
2028157276	Certified as Active	Wireless Phone/Device	Cellular	VERIZON WIRELESS	55 M STREET SE	OITI	jose.colon@dc.gov	Samsung Galaxy S5	Circulator Program
2028158315	Certified as Active	Wireless Phone/Device	Cellular	VERIZON WIRELESS	55 M STREET SE	OD	jose.colon@dc.gov	Samsung Galaxy S5	Jose Colon
2028158350	Certified as Active	Wireless Phone/Device	Cellular	VERIZON WIRELESS	55 M STREET SE	OITI	jose.colon@dc.gov	Samsung Galaxy S5	Jose Colon
2029043855	Certified as Active	Wireless Phone/Device	Cellular	VERIZON WIRELESS	55 M STREET SE	PTSA	anthony.bundy@dc.gov	Blackberry Z10	Anthony Bundy
2029079457	Certified as Active	Wireless Phone/Device	Cellular	VERIZON WIRELESS	55 M STREET SE	HR	sylvester.dixon@dc.gov	Blackberry Z10	Sylvester Dixon
2029079495	Certified as Active	Wireless Phone/Device	Cellular	VERIZON WIRELESS	55 M STREET SE	HR	marcus.pollard@dc.gov	Blackberry Z10	Marcus Pollard
9514154766	Certified as Active	Wireless Phone/Device	Cellular	VERIZON WIRELESS	55 M STREET SE	TOA	marlene.dixon@dc.gov	Modem	Marlene Dixon
2022074665	Certified as Active	Wireless Phone/Device	Cellular	VERIZON WIRELESS	55 M STREET SE	OD	steve.messam@dc.gov	iphone 6	Steve Messam
2022104894	Certified as Active	Wireless Phone/Device	Cellular	VERIZON WIRELESS	55 M STREET SE	OD	Greer.Gilliss@dc.gov	iphone 6	Greer Gillis
2022134170	Certified as Active	Wireless Phone/Device	Cellular	VERIZON WIRELESS	55 M STREET SE	UFA	John.pThomas@dc.gov	Iphone 5s	John Thomas

Phone Number	STATUS	FUNCTIO	SERVICE	VENDOR	SERVICE	ROOM	CONTACT	MODEL_N	CONTACT
2022366956	Certified as Active	Wireless Phone/Device	Cellular	VERIZON WIRELESS	55 M STREET SE	UFA	Kasey.Yturralde@dc.gov	IPhone5	Kasey Yturralde
2022539320	Certified as Active	Wireless Phone/Device	Cellular	VERIZON WIRELESS	55 M STREET SE	OD	reginald.bazile@dc.gov	Blackberry Q10	Reginald Bazile
2022639647	Certified as Active	Wireless Phone/Device	Cellular	VERIZON WIRELESS	55 M STREET SE	OITI	ramakrishna.nimmagadda@dc.gov	iPhone4	Ramakrishna Nimmagadda
2022639656	Certified as Active	Wireless Phone/Device	Cellular	VERIZON WIRELESS	55 M STREET SE	UFA	john.pond@dc.gov	IPhone5	John Pond
2022639892	Certified as Active	Wireless Phone/Device	Cellular	VERIZON WIRELESS	55 M STREET SE	OITI	marlene.dixon@dc.gov	VZW V740	Spare Number
2023218417	Certified as Active	Wireless Phone/Device	Cellular	VERIZON WIRELESS	55 M STREET SE	Civil Rights	lisa.gregory@dc.gov	Blackberry Q10	Lisa Gregory
2023452449	Certified as Active	Wireless Phone/Device	Cellular	VERIZON WIRELESS	55 M STREET SE	OITI	rasheed.ali@dc.gov	Samsung Galaxy S5	Rasheed Ali
2023452608	Certified as Active	Wireless Phone/Device	Cellular	VERIZON WIRELESS	55 M STREET SE	Snow	marlene.dixon@dc.gov	USB Modem 551L	Spare Number
2023452830	Certified as Active	Wireless Phone/Device	Cellular	VERIZON WIRELESS	55 M STREET SE	IPMA	Mandy.Hugh@dc.gov	Blackberry Z10	Mandy Hugh
2023452842	Certified as Active	Wireless Phone/Device	Cellular	VERIZON WIRELESS	55 M STREET SE	IPMA	Maduabuchi.Udeh@dc.gov	Samsung Rugby Pro	Maduabuchi Udeh
2023454061	Certified as Active	Wireless Phone/Device	Cellular	VERIZON WIRELESS	55 M STREET SE	OD	tanya.powell@dc.gov	iphone 5	Tanya Powell
2023590821	Certified as Active	Wireless Phone/Device	Cellular	VERIZON WIRELESS	55 M STREET SE	PTSA	victory.rich@dc.gov	Iphone 5s	Victory Rich
2023592678	Certified as Active	Wireless Phone/Device	Cellular	VERIZON WIRELESS	55 M STREET SE	GC	frank.seales@dc.gov	iphone 6 plus	Frank Seales
2023593684	Certified as Active	Wireless Phone/Device	Cellular	VERIZON WIRELESS	55 M STREET SE				
2023691434	Certified as Active	Wireless Phone/Device	Cellular	VERIZON WIRELESS	55 M STREET SE	OD	felicia.banks@dc.gov	IPhone5	Felicia Banks
2023692296	Certified as Active	Wireless Phone/Device	Cellular	VERIZON WIRELESS	55 M STREET SE	DDOT	Adil.Rizvi@dc.gov	Blackberry Q10	Adil Rizvi

Phone Number	STATUS	FUNCTIO	SERVICE	VENDOR	SERVICE	ROOM	CONTACT	MODEL_N	CONTACT
2023697563	Certified as Active	Wireless Phone/Device	Cellular	VERIZON WIRELESS	55 M STREET SE	OD	Eric.Ampedu@dc.gov	iphone 6	Eric Ampedu
2023918232	Certified as Active	Wireless Phone/Device	Cellular	VERIZON WIRELESS	55 M STREET SE	OITI	jose.colon@dc.gov	Samsung - galaxy 4s	Circulator Program
2023918516	Certified as Active	Wireless Phone/Device	Cellular	VERIZON WIRELESS	55 M STREET SE	IPMA	Dawit.Mulneh@dc.gov	iphone 6	Dawit Mulneh
2024090594	Certified as Active	Wireless Phone/Device	Cellular	VERIZON WIRELESS	55 M STREET SE	OITI	cheryl.ball@dc.gov	iphone 5	Cheryl Ball
2024090991	Certified as Active	Wireless Phone/Device	Cellular	VERIZON WIRELESS	55 M STREET SE	HR	malika.winzor@dc.gov	iPhone 5S 16GB	MALIKA WINZOR
2024228003	Certified as Active	Wireless Phone/Device	Cellular	VERIZON WIRELESS	55 M STREET SE	GC	Nana.Bailey@dc.gov	Iphone 5s	Nana Bailey
2024378576	Certified as Active	Wireless Phone/Device	Cellular	VERIZON WIRELESS	55 M STREET SE	OITI	jose.colon@dc.gov	Samsung - galaxy 4s	Circulator Program
2024386873	Certified as Active	Wireless Phone/Device	Cellular	VERIZON WIRELESS	55 M STREET SE	IPMA	John.Chism@dc.gov	Droid	John Chism
2024394175	Certified as Active	Wireless Phone/Device	Cellular	VERIZON WIRELESS	55 M STREET SE	PIO	Christopher.quay@dc.gov	Iphone 5s	Chris Quay
2024394261	Certified as Active	Wireless Phone/Device	Cellular	VERIZON WIRELESS	55 M STREET SE	OITI	leela.bharani@dc.gov	iphone 6	Leela Bharani
2024394736	Certified as Active	Wireless Phone/Device	Cellular	VERIZON WIRELESS	55 M STREET SE	OITI	Chris.Faust@dc.gov	Galaxy S4	Chris Faust
2024395007	Certified as Active	Wireless Phone/Device	Cellular	VERIZON WIRELESS	55 M STREET SE	OD	Thomas.Coleman@dc.gov	Samsung - galaxy 4s	Thomas Coleman
2024659074	Certified as Active	Wireless Phone/Device	Cellular	VERIZON WIRELESS	55 M STREET SE	OITI	faisal.khan@dc.gov	Galaxy S4	Faisal Khan
2024970164	Certified as Active	Wireless Phone/Device	Cellular	VERIZON WIRELESS	55 M STREET SE	Civil Rights	mohammed.kabir@dc.gov	BlackBerry 6750 GPS	Mohammed Kabir
2024970227	Certified as Active	Wireless Phone/Device	Cellular	VERIZON WIRELESS	55 M STREET SE	UFA	earl.eutsler@dc.gov	Samsung Galaxy S6	Earl Eutsler
2024973022	Certified as Active	Wireless Phone/Device	Cellular	VERIZON WIRELESS	55 M STREET SE	UFA	Evan.Anderson@dc.gov	iphone 6S	Evan Anderson

Phone Number	STATUS	FUNCTIO	SERVICE	VENDOR	SERVICE	ROOM	CONTACT	MODEL_N	CONTACT
2024973187	Certified as Active	Wireless Phone/Device	Cellular	VERIZON WIRELESS	55 M STREET SE	GC	frank.seales@dc.gov	iphone 6 plus	Frank Seales
2024974724	Certified as Active	Wireless Phone/Device	Cellular	VERIZON WIRELESS	55 M STREET SE	IPMA	Troy.Brogden@dc.gov	Samsung Galaxy S5	Troy Brogden
2024977173	Certified as Active	Wireless Phone/Device	Cellular	VERIZON WIRELESS	55 M STREET SE	GC	cheri.staples@dc.gov	iphone 6 plus	Cheri Staples
2024977216	Certified as Active	Wireless Phone/Device	Cellular	VERIZON WIRELESS	55 M STREET SE	OITI	khalif.hired@dc.gov	Samsung Galaxy S6	Khalif Hired
2024977808	Certified as Active	Wireless Phone/Device	Cellular	VERIZON WIRELESS	55 M STREET SE	PSRA	Walter.Graham@dc.gov	Iphone 5s	Walter Graham
2024978040	Certified as Active	Wireless Phone/Device	Cellular	VERIZON WIRELESS	55 M STREET SE	IPMA	Wasi.Khan@dc.gov	Droid	Wasi Khan
2025072828	Certified as Active	Wireless Phone/Device	Cellular	VERIZON WIRELESS	55 M STREET SE	OITI	marlene.p.johnson@dc.gov	Samsung Galaxy S5	Marlene Johnson
2025273054	Certified as Active	Wireless Phone/Device	Cellular	VERIZON WIRELESS	55 M STREET SE	OD	Taryn.Farber@dc.gov	iphone 6S	Taryn Farber
2025317531	Certified as Active	Wireless Phone/Device	Cellular	VERIZON WIRELESS	55 M STREET SE	Frank Seales	karen.calmeise@dc.gov	iphone 6	Karen Calmeise
2025317563	Certified as Active	Wireless Phone/Device	Cellular	VERIZON WIRELESS	55 M STREET SE	IPMA	Abdullahi.Mohamed@dc.gov	Samsung Galaxy S5	Abdullahi Mohamed
2025538336	Certified as Active	Wireless Phone/Device	Cellular	VERIZON WIRELESS	55 M STREET SE	OITI	Washington.Karvee@dc.gov	iphone 5	Washington Karvee
2025538359	Certified as Active	Wireless Phone/Device	Cellular	VERIZON WIRELESS	55 M STREET SE	OITI	jose.colon@dc.gov	Samsung - galaxy 4s	Circulator Program
2025538374	Certified as Active	Wireless Phone/Device	Cellular	VERIZON WIRELESS	55 M STREET SE	OD	James.graham@dc.gov	iphone 5	James Graham
2027315009	Certified as Active	Wireless Phone/Device	Cellular	VERIZON WIRELESS	55 M STREET SE	OITI	jose.colon@dc.gov	Samsung - galaxy 4s	Circulator Program
2027315014	Certified as Active	Wireless Phone/Device	Cellular	VERIZON WIRELESS	55 M STREET SE	TOA	Soumya.dey@dc.gov	BOLD 9650	Soumya Dey
2029077012	Certified as Active	Wireless Phone/Device	Cellular	VERIZON WIRELESS	55 M STREET SE	OITI	jose.colon@dc.gov	Samsung - galaxy 4s	Circulator Program

Phone Number	STATUS	FUNCTIO	SERVICE	VENDOR	SERVICE	ROOM	CONTACT	MODEL_N	CONTACT
2029077226	Certified as Active	Wireless Phone/De vice	Cellular	VERIZON WIRELESS	55 M STREET SE	OITI	george.lej ano@dc.g ov	Samsung - galaxy 4s	George Lejano
2029077298	Certified as Active	Wireless Phone/De vice	Cellular	VERIZON WIRELESS	55 M STREET SE	OD	ledesma.s mith- mathis@d c.gov	Samsung - galaxy 4s	Ledesma Smith- Mathis
2029970350	Certified as Active	Wireless Phone/De vice	Cellular	VERIZON WIRELESS	55 M STREET SE	OITI	jose.colon @dc.gov	Samsung - galaxy 4s	Circulator Program

Phone Number	STATUS	FUNCTIO	SERVICE	VENDOR	SERVICE	ROOM	CONTACT	MODEL_N	CONTACT
2022150323	Certified as Active	Wireless Phone/Device	Tablet	AT&T Wireless	55 M STREET SE	OITI	marlene.dixon@dc.gov	iPad tablet	Sign-In Telecom Tablet
2022151031	Certified as Active	Wireless Phone/Device	Tablet	AT&T Wireless	55 M STREET SE	OITI	jonathan.wilson@dc.gov		Spare Tablet
2022154374	Certified as Active	Wireless Phone/Device	Tablet	AT&T Wireless	1338 G STREET SE	Citywide	chauncey.taylor@dc.gov	iPad tablet	Chauncey Taylor
2022155620	Certified as Active	Wireless Phone/Device	Tablet	AT&T Wireless	1338 G STREET SE	Citywide TOA	chauncey.taylor@dc.gov	iPad tablet	Chauncey Taylor
2022157079	Certified as Active	Wireless Phone/Device	Tablet	AT&T Wireless	1338 G STREET SE	Citywide TOA	Reginald.carmichael@dc.gov	iPad tablet	Reginald Carmichael
2022157428	Certified as Active	Wireless Phone/Device	Tablet	AT&T Wireless	1338 G STREET SE	Citywide TOA	Reggie.McCoy@dc.gov	iPad tablet	Reggie McCoy
2022158436	Certified as Active	Wireless Phone/Device	Tablet	AT&T Wireless	1338 G STREET SE	Citywide TOA	Michael.McIntosh@dc.gov	iPad tablet	Michael McIntosh
2022853645	Certified as Active	Wireless Phone/Device	Tablet	AT&T Wireless	55 M STREET SE	PSRA	James.henry@dc.gov		Jame Henry
2022857791	Certified as Active	Wireless Phone/Device	Tablet	AT&T Wireless	55 M STREET SE	UFA	carlson.klapthor@dc.gov		Carlson Klapthor
2022861129	Certified as Active	Wireless Phone/Device	Tablet	AT&T Wireless	55 M STREET SE	UFA	shaun.mckim@dc.gov	AT&T Pansasonic Tough Pads	Shaun McKim
2022862071	Certified as Active	Wireless Phone/Device	Tablet	AT&T Wireless	55 M STREET SE	PSRA	Robert.lee@dc.gov	AT&T Pansasonic Tough Pads	Robert Lee
2022862390	Certified as Active	Wireless Phone/Device	Tablet	AT&T Wireless	55 M STREET SE	PSRA	marlene.dixon@dc.gov	AT&T Pansasonic Tough Pads	Under Investigation
2022863218	Certified as Active	Wireless Phone/Device	Tablet	AT&T Wireless	55 M STREET SE	PSRA	Marvin.McFadden@dc.gov	AT&T Pansasonic Tough Pads	Marvin McFadden
2022865674	Certified as Active	Wireless Phone/Device	Tablet	AT&T Wireless	55 M STREET SE	PSRA	Mildred.summers@dc.gov	AT&T Pansasonic Tough Pads	Mildred Summers

Phone Number	STATUS	FUNCTIO	SERVICE	VENDOR	SERVICE	ROOM	CONTACT	MODEL_N	CONTACT
2022866845	Certified as Active	Wireless Phone/Device	Tablet	AT&T Wireless	55 M STREET SE	UFA	steve.mckindleyward@dc.gov	AT&T Pansasonic Tough Pads	Steve McKindley
2022868539	Certified as Active	Wireless Phone/Device	Tablet	AT&T Wireless	55 M STREET SE	UFA	joseph.burckle@dc.gov	AT&T Pansasonic Tough Pads	Joseph Burckle
2022868627	Certified as Active	Wireless Phone/Device	Tablet	AT&T Wireless	55 M STREET SE	UFA	duff.mccully@dc.gov	AT&T Pansasonic Tough Pads	Duff Mccully
2022868709	Certified as Active	Wireless Phone/Device	Tablet	AT&T Wireless	55 M STREET SE	UFA	munevver.ertem@dc.gov	AT&T Pansasonic Tough Pads	Munevver Ertem
2022868975	Certified as Active	Wireless Phone/Device	Tablet	AT&T Wireless	55 M STREET SE	PSRA	Haywood.Richardson@dc.gov	AT&T Pansasonic Tough Pads	Haywood Richardson
2022881102	Certified as Active	Wireless Phone/Device	Tablet	AT&T Wireless	55 M STREET SE	PSRA	James.Childs@dc.gov	AT&T Pansasonic Tough Pads	James Childs
2022882397	Certified as Active	Wireless Phone/Device	Tablet	AT&T Wireless	55 M STREET SE	PSRA	Elliott.garrett@dc.gov	AT&T Pansasonic Tough Pads	Elliott Garrett
2022884451	Certified as Active	Wireless Phone/Device	Tablet	AT&T Wireless	55 M STREET SE	UFA	john.pond@dc.gov		John Pond
2023047769	Certified as Active	Wireless Phone/Device	Tablet	AT&T Wireless	55 M STREET SE	OITI	jonathan.wilson@dc.gov		Spare Tablet
2023228402	Certified as Active	Wireless Phone/Device	Tablet	AT&T Wireless	55 M STREET SE	PSRA	jonathan.wilson@dc.gov		Spare Tablet
2023414376	Certified as Active	Wireless Phone/Device	Tablet	AT&T Wireless	55 M STREET SE	UFA	jack.chapman@dc.gov		Jack Chapman
2023415674	Certified as Active	Wireless Phone/Device	Tablet	AT&T Wireless	55 M STREET SE	OITI	jonathan.wilson@dc.gov		Jonathan Wilson
2023415698	Certified as Active	Wireless Phone/Device	Tablet	AT&T Wireless	55 M STREET SE	OITI	jonathan.wilson@dc.gov		Spare Tablet

Phone Number	STATUS	FUNCTIO	SERVICE	VENDOR	SERVICE	ROOM	CONTACT	MODEL_N	CONTACT
2023415785	Certified as Active	Wireless Phone/Device	Tablet	AT&T Wireless	55 M STREET SE	PSRA	Raymond. McLeod@dc.gov	AT&T Pansasonic Tough Pads	Raymond McLeod
2023416398	Certified as Active	Wireless Phone/Device	Tablet	AT&T Wireless	55 M STREET SE	UFA	john.oneil@dc.gov		John Oneil
2023419235	Certified as Active	Wireless Phone/Device	Tablet	AT&T Wireless	55 M STREET SE	UFA	joel.conlon@dc.gov		Joel Conlon
2023419356	Certified as Active	Wireless Phone/Device	Tablet	AT&T Wireless	55 M STREET SE	UFA	william.heist@dc.gov		William Heist
2023445820	Certified as Active	Wireless Phone/Device	Tablet	AT&T Wireless	55 M STREET SE	OITI	Jonathan.wilson@dc.gov	AT&T Pansasonic Tough Pads	Spare Tablet Spare Tablet
2023511114	Certified as Active	Wireless Phone/Device	Tablet	AT&T Wireless	55 M STREET SE	UFA	robert.corletta@dc.gov		Robert Corletta
2023555083	Certified as Active	Wireless Phone/Device	Tablet	AT&T Wireless	55 M STREET SE	UFA	steve.mckindleyward@dc.gov		Steve McKindley Ward
2023555141	Certified as Active	Wireless Phone/Device	Tablet	AT&T Wireless	55 M STREET SE	OITI	jonathan.wilson@dc.gov		Spare Tablet
2023558407	Certified as Active	Wireless Phone/Device	Tablet	AT&T Wireless	55 M STREET SE	UFA	michael.chuko@dc.gov		Michael Choko
2023680380	Certified as Active	Wireless Phone/Device	Tablet	AT&T Wireless	55 M STREET SE	PSRA	vacara.matthews@dc.gov	AT&T Pansasonic Tough Pads	Vacara Matthews
2023681965	Certified as Active	Wireless Phone/Device	Tablet	AT&T Wireless	55 M STREET SE	OITI	jonathan.wilson@dc.gov		Jonathan Wilson
2023682646	Certified as Active	Wireless Phone/Device	Tablet	AT&T Wireless	55 M STREET SE	UFA	janet.miller@dc.gov		Janet Miller
2023682795	Certified as Active	Wireless Phone/Device	Tablet	AT&T Wireless	55 M STREET SE	UFA	eboni.hall@dc.gov		Eboni Hall
2023684293	Certified as Active	Wireless Phone/Device	Tablet	AT&T Wireless	55 M STREET SE	UFA	earl.eutlsler@dc.gov		Earl Eutlsler
2023689305	Certified as Active	Wireless Phone/Device	Tablet	AT&T Wireless	55 M STREET SE	OITI	jonathan.wilson@dc.gov		Jonathan Wilson
2023743989	Certified as Active	Wireless Phone/Device	Tablet	AT&T Wireless	55 M STREET SE	OITI	jonathan.wilson@dc.gov		Jonathan Wilson

Phone Number	STATUS	FUNCTIO	SERVICE	VENDOR	SERVICE	ROOM	CONTACT	MODEL_N	CONTACT
2023745351	Certified as Active	Wireless Phone/Device	Tablet	AT&T Wireless	55 M STREET SE	OITI	Jonathan.Wilson@dc.gov	Samsung ATIV	Jonathan Wilson
2024272170	Certified as Active	Wireless Phone/Device	Tablet	AT&T Wireless	55 M STREET SE	IPMA	marlene.dixon@dc.gov		Under Investigation
2024310187	Certified as Active	Wireless Phone/Device	Tablet	AT&T Wireless	55 M STREET SE	OITI	Greer.hill@dc.gov	Samsung ATIV	Greer Hill
2024310415	Certified as Active	Wireless Phone/Device	Tablet	AT&T Wireless	55 M STREET SE	TST	Dawit.Muluneh@dc.gov		Dawit Muluneh
2024310624	Certified as Active	Wireless Phone/Device	Tablet	AT&T Wireless	55 M STREET SE	IPMA	Keith.foxx@dc.gov		Keith Foxx
2024311625	Certified as Active	Wireless Phone/Device	Tablet	AT&T Wireless	55 M STREET SE	OITI	Turnesha.fish@dc.gov		Turnesha Fish
2024312072	Certified as Active	Wireless Phone/Device	Tablet	AT&T Wireless	55 M STREET SE	IPMA	Frank.Montenegro@dc.gov		Frank Montenegro
2024314205	Certified as Active	Wireless Phone/Device	Tablet	AT&T Wireless	55 M STREET SE	OITI	jonathan.wilson@dc.gov		Jonathan Wilson
2024454236	Certified as Active	Wireless Phone/Device	Tablet	AT&T Wireless	55 M STREET SE	OCFO	Calvin.Skinner@dc.gov		Calvin Skinner
2026796495	Certified as Active	Wireless Phone/Device	Tablet	AT&T Wireless	55 M STREET SE	UFA	simoun.banua@dc.gov		Simoun Banua
2027018632	Certified as Active	Wireless Phone/Device	Tablet	AT&T Wireless	55 M STREET SE	UFA	John.pthomas@dc.gov	iPad tablet	John Thomas
2027146429	Certified as Active	Wireless Phone/Device	Tablet	AT&T Wireless	55 M STREET SE	OITI	jonathan.wilson@dc.gov	Samsung Rugby Pro	Spare Tablet
2027146928	Certified as Active	Wireless Phone/Device	Tablet	AT&T Wireless	55 M STREET SE	IPMA	Konjit.Eskender@dc.gov	Samsung ATIV	Konjit Eskender
2027160417	Certified as Active	Wireless Phone/Device	Tablet	AT&T Wireless	55 M STREET SE	IPMA	marlene.dixon@dc.gov	Samsung ATIV	Under Investigation
2027163168	Certified as Active	Wireless Phone/Device	Tablet	AT&T Wireless	55 M STREET SE	IPMA	Troy.Brogden@dc.gov	Samsung ATIV	Troy Brogden
2027163873	Certified as Active	Wireless Phone/Device	Tablet	AT&T Wireless	55 M STREET SE	PSRA	Kirk.benson@dc.gov	Samsung ATIV	Kirk Benson
2027166823	Certified as Active	Wireless Phone/Device	Tablet	AT&T Wireless	55 M STREET SE	OITI	jonathan.wilson@dc.gov		Jonathan Wilson
2027330772	Certified as Active	Wireless Phone/Device	Tablet	AT&T Wireless	55 M STREET SE	IPMA	marlene.dixon@dc.gov	Samsung ATIV	Under Investigation

Phone Number	STATUS	FUNCTIO	SERVICE	VENDOR	SERVICE	ROOM	CONTACT	MODEL_N	CONTACT
2027337465	Certified as Active	Wireless Phone/Device	Tablet	AT&T Wireless	55 M STREET SE	PSRA	paul.carraway@dc.gov		Paul Carraway
2027460955	Certified as Active	Wireless Phone/Device	Tablet	AT&T Wireless	55 M STREET SE	TST	victor.nwabueze@dc.gov		Victor Nwabueze
2027464211	Certified as Active	Wireless Phone/Device	Tablet	AT&T Wireless	55 M STREET SE	OITI	Khalif.hired@dc.gov	Samsung ATIV	Khalif Hired
2027467106	Certified as Active	Wireless Phone/Device	Tablet	AT&T Wireless	55 M STREET SE	OITI	jonathan.wilson@dc.gov		Jonathan Wilson
2027467168	Certified as Active	Wireless Phone/Device	Tablet	AT&T Wireless	55 M STREET SE	IPMA	marlene.dixon@dc.gov	Samsung ATIV	Under Investigation
2027654172	Certified as Active	Wireless Phone/Device	Tablet	AT&T Wireless	55 M STREET SE	OITI	Jonathan.wilson@dc.gov		Under Investigation
2027654175	Certified as Active	Wireless Phone/Device	Tablet	AT&T Wireless	55 M STREET SE	OITI	jonathan.wilson@dc.gov		Jonathan Wilson
2027654196	Certified as Active	Wireless Phone/Device	Tablet	AT&T Wireless	55 M STREET SE	Asset Mgmt	Adrian.moon@dc.gov		Adrian Moon
2027658150	Certified as Active	Wireless Phone/Device	Tablet	AT&T Wireless	55 M STREET SE	IPMA	marlene.dixon@dc.gov	Samsung ATIV	Under Investigation
2027658152	Certified as Active	Wireless Phone/Device	Tablet	AT&T Wireless	55 M STREET SE	OITI	derrick.marrow@dc.gov		Derrick Marrow
2027658153	Certified as Active	Wireless Phone/Device	Tablet	AT&T Wireless	1338 G STREET SE	Citywide	Randolph.cooper@dc.gov	Samsung ATIV	Randolph Cooper
2027658159	Certified as Active	Wireless Phone/Device	Tablet	AT&T Wireless	55 M STREET SE	OITI	jonathan.wilson@dc.gov		Jonathan Wilson
2027658160	Certified as Active	Wireless Phone/Device	Tablet	AT&T Wireless	55 M STREET SE	IPMA	marlene.dixon@dc.gov	Samsung ATIV	Under Investigation
2027658161	Certified as Active	Wireless Phone/Device	Tablet	AT&T Wireless	55 M STREET SE	6th FL	michael.jernagin@dc.gov		Michael Jernagin
2027658163	Certified as Active	Wireless Phone/Device	Tablet	AT&T Wireless	55 M STREET SE	6th FL	james.cheeks@dc.gov		James Cheeks
2027658167	Certified as Active	Wireless Phone/Device	Tablet	AT&T Wireless	55 M STREET SE	UFA	earl.eutsler@dc.gov		Earl Eutsler
2027658170	Certified as Active	Wireless Phone/Device	Tablet	AT&T Wireless	55 M STREET SE	OITI	jonathan.wilson@dc.gov		Jonathan Wilson
2027658172	Certified as Active	Wireless Phone/Device	Tablet	AT&T Wireless	55 M STREET SE	IPMA	marlene.dixon@dc.gov	Samsung ATIV	Under Investigation
2027658190	Certified as Active	Wireless Phone/Device	Tablet	AT&T Wireless	55 M STREET SE	IPMA	marlene.dixon@dc.gov	Samsung ATIV	Under Investigation

Phone Number	STATUS	FUNCTIO	SERVICE	VENDOR	SERVICE	ROOM	CONTACT	MODEL_N	CONTACT
2027658191	Certified as Active	Wireless Phone/Device	Tablet	AT&T Wireless	55 M STREET SE	PPSA	james.henry@dc.gov	Samsung ATIV	Henry James
2027658192	Certified as Active	Wireless Phone/Device	Tablet	AT&T Wireless	55 M STREET SE	OITI	jonathan.wilson@dc.gov		Jonathan Wilson
2027658194	Certified as Active	Wireless Phone/Device	Tablet	AT&T Wireless	1338 G STREET SE	Citywide	marlene.dixon@dc.gov	Samsung ATIV	Under Investigation
2027658196	Certified as Active	Wireless Phone/Device	Tablet	AT&T Wireless	55 M STREET SE	PPSA	gilberto.solano@dc.gov		Gliberto Solano
2027658198	Certified as Active	Wireless Phone/Device	Tablet	AT&T Wireless	55 M STREET SE	IPMA	jessica.bembry@dc.gov		Jessica Bembry
2027658201	Certified as Active	Wireless Phone/Device	Tablet	AT&T Wireless	55 M STREET SE	IPMA	Elijah.robison@dc.gov	Samsung ATIV	Elijah Robinson
2027696329	Certified as Active	Wireless Phone/Device	Tablet	AT&T Wireless	55 M STREET SE	OITI	jonathan.wilson@dc.gov		Jonathan Wilson
2027696712	Certified as Active	Wireless Phone/Device	Tablet	AT&T Wireless	55 M STREET SE	OITI	George.lejano@dc.gov	Samsung ATIV	George Lejano
2027696721	Certified as Active	Wireless Phone/Device	Tablet	AT&T Wireless	55 M STREET SE	OITI	marlene.dixon@dc.gov		Under Investigation
2027696732	Certified as Active	Wireless Phone/Device	Tablet	AT&T Wireless	55 M STREET SE	OITI	Faisal.khan@dc.gov	Samsung ATIV	Faisal Khan
2029077318	Certified as Active	Wireless Phone/Device	Tablet	AT&T Wireless	55 M STREET SE	OITI	jonathan.wilson@dc.gov	i680	Spare tablet

Phone Number	STATUS	FUNCTIO	SERVICE	VENDOR	SERVICE	ROOM	CONTACT	MODEL_N	CONTACT
2025940299	Certified as Active	Wireless Phone/De vice	Tablet	T-Mobile	55 M STREET SE	OITI	JoAnn.Lo we@dc.go v	IPad Air	JoAnn Lowe
2025945330	Certified as Active	Wireless Phone/De vice	Tablet	T-Mobile	55 M STREET SE	PPSA	angelica.j ohnson@ dc.gov	IPad Air	Angelica Johnson
2025945750	Certified as Active	Wireless Phone/De vice	Tablet	T-Mobile	55 M STREET SE	PPSA	Norman.G ross@dc.g ov	IPad Air	Norman Gross
2026830812	Certified as Active	Wireless Phone/De vice	Tablet	T-Mobile	55 M STREET SE	SBM	jason.jone s@dc.gov		Jason Jones

Fleet Tag	Make	Model	Year	Location	Department
98-1064	Chevrolet	S-10 Pickup	2002	55 M St. SE	Public Space Regulatory Admin
98-2418	Chevrolet	S-10 Pickup	2003	55 M St. SE	Public Space Regulatory Admin
98-2505	Chevrolet	C2500 Pickup	2003	55 M St. SE	Public Space Regulatory Admin
98-4876	Ford	Ranger Pickup	2008	55 M St. SE	Public Space Regulatory Admin
98-4877	Ford	Ranger Pickup	2008	55 M St. SE	Public Space Regulatory Admin
98-4878	Ford	Ranger Pickup	2008	55 M St. SE	Public Space Regulatory Admin
98-4879	Ford	Ranger Pickup	2001	55 M St. SE	Public Space Regulatory Admin
98-4866	Ford	Ranger Pickup	2008	55 M St. SE	Public Space Regulatory Admin
98-4901	Ford	Ranger Pickup	2008	55 M St. SE	Public Space Regulatory Admin
98-4921	Ford	Ranger Pickup	2008	55 M St. SE	Public Space Regulatory Admin
98-4922	Ford	Ranger Pickup	2008	55 M St. SE	Public Space Regulatory Admin
98-6350	Ford	Ranger Pickup	2008	55 M St. SE	Public Space Regulatory Admin
98-7869	Chevrolet	C2500 Pickup	2011	55 M St. SE	Public Space Regulatory Admin
98-8326	Ford	F-150	2012	55 M St. SE	Public Space Regulatory Admin
98-8335	Ford	F-150	2012	55 M St. SE	Public Space Regulatory Admin
98-8336	Ford	F-150	2012	55 M St. SE	Public Space Regulatory Admin
98-8654	Ford	F-150	2012	55 M St. SE	Public Space Regulatory Admin
98-8828	Dodge	Grand Caravan	2014	55 M St. SE	Public Space Regulatory Admin
98-10237	Toyota	Tacoma	2013	55 M St. SE	Public Space Regulatory Admin
98-10297	Dodge	Ram 1500 SLT	2013	55 M St. SE	Public Space Regulatory Admin
98-10554	Toyota	Tacoma	2015	55 M St. SE	Public Space Regulatory Admin
98-10714	Toyota	Tacoma	2015	55 M St. SE	Public Space Regulatory Admin
98-10719	Toyota	Tacoma	2015	55 M St. SE	Public Space Regulatory Admin
98-11040	Chevrolet	TCW	2015	55 M St. SE	Public Space Regulatory Admin
98-1074	Chevrolet	S-10 Pickup	2002	1100 4th St. SW	Public Space Regulatory Admin
98-2759	Ford	Focus	2001	1100 4th St. SW	Public Space Regulatory Admin
98-4880	Ford	Ranger Pickup	2008	1100 4th St. SW	Public Space Regulatory Admin
98-4881	Ford	Ranger Pickup	2008	1100 4th St. SW	Public Space Regulatory Admin
98-4886	Ford	Ranger Pickup	2008	1100 4th St. SW	Public Space Regulatory Admin
98-7149	Ford	Ranger Pickup	2008	1100 4th St. SW	Public Space Regulatory Admin
98-7595	International	4900 6 Wheel Dump	2001	1403 Wst NE	Public Space Regulatory Admin
98-1119	Chevrolet	Blazer	2002	55 M St. SE	Public Space Regulatory Admin
98-0844	Chevrolet	S-10 Pickup	2002	55 M St. SE	Public Space Regulatory Admin
98-2513	Chevrolet	C2500 Pickup	2003	55 M St. SE	Public Space Regulatory Admin
98-1034	Chevrolet	S-10 Pickup	2002	55 M St. SE	Public Space Regulatory Admin
98-2510	Chevrolet	C2500 Pickup	2003	55 M St. SE	Public Space Regulatory Admin
98-11204	Dodge	RAM ST 4x4 1500	2015	55 M St. SE	Public Space Regulatory Admin
98-0142	Ford	F-250	2001	1338 Rear G St. SE	Office of The Director
98-2411	Chevrolet	S-10 Pickup	2003	55 M St. SE	Office of The Director
98-6104	Chevrolet	Suburban	2007	55 M St. SE	Office of The Director
98-6757	Chevrolet	Impala	2009	55 M St. SE	Office of The Director
98-9689	Dodge	Caravan SE	2013	55 M St. SE	Office of The Director
98-7638	Ford	Escape Hybrid	2011	55 M St. SE	Office of The Director
98-8337	Ford	F-150	2012	1338 Rear G St. SE	Office of The Director
98-9797	Toyota	Tacoma	2013	55 M St. SE	Office of The Director
98-10660	Dodge	Grand Caravan	2014	55 M St. SE	Office of The Director
98-10591	Toyota	Corolla LE	2014	55 M St. SE	Office of The Director
98-10240	Toyota	Tacoma	2013	55 M St. SE	Office of The Director
98-8158	Mitsubishi	Forklift	1999	1338 Rear G St. SE	Field Operation Division
98-3824	Ford	Bucket Truck	2004	1338 Rear G St. SE	Field Operation Division
98-3865	Ford	Bucket Truck	2004	1338 Rear G St. SE	Field Operation Division
98-3957	Ford	F-550	2005	1338 Rear G St. SE	Field Operation Division
98-3959	Ford	Bucket Truck	2005	1338 Rear G St. SE	Field Operation Division
98-4008	Ford	F-650	2005	1338 Rear G St. SE	Field Operation Division
98-7865	Chevrolet	Silverado	2011	1338 Rear G St. SE	Field Operation Division
98-7866	Chevrolet	Silverado	2011	1338 Rear G St. SE	Field Operation Division
98-7867	Chevrolet	Silverado	2011	1338 Rear G St. SE	Field Operation Division
98-7868	Chevrolet	Silverado	2011	1338 Rear G St. SE	Field Operation Division
98-8234	Chevrolet	Silverado	2012	1338 Rear G St. SE	Field Operation Division
98-8235	Chevrolet	Silverado	2012	1338 Rear G St. SE	Field Operation Division
98-8305	Ford	Bucket Truck	2005	1338 Rear G St. SE	Field Operation Division
98-8796	Ford	F-550 Bucket Truck	2015	1338 Rear G St. SE	Field Operation Division
98-8797	Ford	F-550 Bucket Truck	2014	1338 Rear G St. SE	Field Operation Division
98-9979	Chevrolet	Silverado LS	2015	1338 Rear G St. SE	Field Operation Division
98-10239	Toyota	Tacoma	2013	1338 Rear G St. SE	Field Operation Division
98-10552	Toyota	Tacoma	2015	1338 Rear G St. SE	Field Operation Division
98-10758	Ford	E-350 Superduty	2014	1338 Rear G St. SE	Field Operation Division
98-10759	Ford	E-350 Superduty	2014	1338 Rear G St. SE	Field Operation Division
98-11038	Chevrolet	Silverado 1500	2015	1338 Rear G St. SE	Field Operation Division
98-10153	International	Terrastar	2013	1338 Rear G St. SE	Field Operation Division
98-G214	Honda	Motor LTD	2015	1338 Rear G St. SE	Field Operation Division
98-G348	Honda	Motor LTD	2015	1338 Rear G St. SE	Field Operation Division
98-G739	Honda	Motor LTD	2015	1338 Rear G St. SE	Field Operation Division
98-5338	Mitsubishi	Forklift	2002	1338 Rear G St. SE	Field Operation Division
98-8198	Worthington	Trailer	2012	1338 Rear G St. SE	Field Operation Division
98-0850	Yale	Forklift	1997	1338 Rear G St. SE	Field Operation Division
98-2832	Chevrolet	Silverado LS	2001	1338 Rear G St. SE	Field Operation Division
98-0450	Dodge	Van	2001	1338 Rear G St. SE	Field Operation Division
98-1015	Dodge	Van	2001	1338 Rear G St. SE	Field Operation Division
98-4872	Ford	Ranger Pickup	2008	1338 Rear G St. SE	Field Operation Division
98-4874	Ford	Ranger Pickup	2008	1338 Rear G St. SE	Field Operation Division
98-0216	International	Stakebody	2000	1338 Rear G St. SE	Field Operation Division
98-2838	Chevrolet	4x4 pickup	2001	1338 Rear G St. SE	Field Operation Division
98-4079	Chevrolet	Silverado LS	2001	1338 Rear G St. SE	Field Operation Division
98-7321	Ford	Van	2010	55 M St. SE	Policy and Planning Sustainability Admin
98-6425	Dodge	R-1500 4x4	2007	2000 14th St. (Reeves Ctr.)	Traffic Control Officers

98-3586	National	Trailer	2003	1735 15th Street NE	Roadway Operations Patrol
98-4401	PSI	Trailer	2005	1735 15th Street NE	Roadway Operations Patrol
98-4402	PSI	Trailer	2005	1735 15th Street NE	Roadway Operations Patrol
98-4405	PSI	Trailer	2005	1735 15th Street NE	Roadway Operations Patrol
98-5489	Continental	Trailer	2004	1735 15th Street NE	Roadway Operations Patrol
98-0894	Ford	Expedition	2001	1735 15th Street NE	Roadway Operations Patrol
98-1181	Ford	Ultimaster	2002	1735 15th Street NE	Roadway Operations Patrol
98-1462	Chevrolet	3500	2004	1735 15th Street NE	Roadway Operations Patrol
98-1035	Chevrolet	S-10 Pickup	2002	55 M St. SE	Infrastructure Project Management Admin
98-2414	Chevrolet	S-10 Pickup	2003	55 M St. SE	Infrastructure Project Management Admin
98-3352	Chevrolet	Blazer	2001	55 M St. SE	Infrastructure Project Management Admin
98-6967	Ford	Taurus	2002	55 M St. SE	Infrastructure Project Management Admin
98-8339	Ford	F-150	2012	55 M St. SE	Infrastructure Project Management Admin
98-8340	Ford	F-150	2012	55 M St. SE	Infrastructure Project Management Admin
98-9377	Toyota	Corolla LE	2013	55 M St. SE	Infrastructure Project Management Admin
98-9686	Dodge	Caravan SE	2013	55 M St. SE	Infrastructure Project Management Admin
98-9688	Dodge	Caravan SE	2013	55 M St. SE	Infrastructure Project Management Admin
98-9787	Toyota	Tacoma	2013	55 M St. SE	Infrastructure Project Management Admin
98-9788	Toyota	Tacoma	2013	55 M St. SE	Infrastructure Project Management Admin
98-9789	Toyota	Tacoma	2013	55 M St. SE	Infrastructure Project Management Admin
98-9790	Toyota	Tacoma	2013	55 M St. SE	Infrastructure Project Management Admin
98-9791	Toyota	Tacoma	2013	55 M St. SE	Infrastructure Project Management Admin
98-9792	Toyota	Tacoma	2013	55 M St. SE	Infrastructure Project Management Admin
98-9793	Toyota	Tacoma	2013	55 M St. SE	Infrastructure Project Management Admin
98-9794	Toyota	Tacoma	2013	55 M St. SE	Infrastructure Project Management Admin
98-9846	Toyota	Tacoma	2013	55 M St. SE	Infrastructure Project Management Admin
98-9847	Toyota	Tacoma	2013	55 M St. SE	Infrastructure Project Management Admin
98-9849	Toyota	Tacoma	2013	55 M St. SE	Infrastructure Project Management Admin
98-10249	Dodge	Grand Caravan	2014	55 M St. SE	Infrastructure Project Management Admin
98-10250	Dodge	Grand Caravan	2014	55 M St. SE	Infrastructure Project Management Admin
98-1993	Chevrolet	S-10 Pickup	2003	55 M St. SE	Infrastructure Project Management Admin
98-1994	Chevrolet	S-10 Pickup	2003	55 M St. SE	Infrastructure Project Management Admin
98-11206	Dodge	RAM ST 4x4 1500	2015	55 M St. SE	Infrastructure Project Management Admin
98-11208	Dodge	RAM ST 4x4 1500	2015	55 M St. SE	Infrastructure Project Management Admin
98-11209	Dodge	Ram 1500 SLT	2015	55 M St. SE	Infrastructure Project Management Admin
98-11205	Dodge	RAM ST 4x4 1500	2015	55 M St. SE	Infrastructure Project Management Admin
98-11207	Dodge	RAM ST 4x4 1500	2015	55 M St. SE	Infrastructure Project Management Admin
98-11202	Dodge	RAM ST 4x4 1500	2015	55 M St. SE	Infrastructure Project Management Admin
98-11203	Dodge	RAM ST 4x4 1500	2015	55 M St. SE	IPMA Assessment Management Division
98-2507	Chevrolet	Pickup Truck	2003	400 McMillian Dr. NW	IPMA Assessment Management Division
98-2506	Chevrolet	Pick-up	2003	400 McMillian Dr. NW	IPMA QA/QC Division
98-2500	Chevrolet	S-10 Pickup	2003	400 McMillian Dr. NW	IPMA QA/QC Division
98-2580	Chevrolet	Pickup Truck	2003	400 McMillian Dr. NW	IPMA QA/QC Division
98-4073	Chevrolet	Silverado LS	2001	400 McMillian Dr. NW	IPMA QA/QC Division
98-4882	Ford	Ranger Pickup	2008	400 McMillian Dr. NW	IPMA QA/QC Division
98-9850	Toyota	Tacoma	2013	400 McMillian Dr. NW	IPMA QA/QC Division
98-7534	Chevrolet	Silverado	2003	400 McMillian Dr. NW	IPMA QA/QC Division
98-10371	Toyota	Tacoma	2013	400 McMillian Dr. NW	IPMA QA/QC Division
98-11210	Dodge	1500 Pickup	2015	400 McMillian Dr. NW	IPMA QA/QC Division
98-W0157	Bobcat	Generator	2011	1403 Wst NE	Street and Bridge Wst.
98-W1463	Bobcat	Generator	2011	1403 Wst NE	Street and Bridge Wst.
98-9247	International	4900 6 Wheel Dump	2001	1403 Wst NE	Street and Bridge Wst.
98-7136	Ford	F-550	2008	1403 Wst NE	Street and Bridge Wst.
98-0818	Trafcon	Trailer	2002	1403 Wst NE	Street and Bridge Wst.
98-4927	Henchman	4 HSM	2006	1403 Wst NE	Street and Bridge Wst.
98-0138	Ford	Utility Truck	2001	1403 Wst NE	Street and Bridge Wst.
98-0365	International	4900 6 Wheel Dump	2001	1403 Wst NE	Street and Bridge Wst.
98-2541	Chevrolet	Pickup Truck	2003	1403 Wst NE	Street and Bridge Wst.
98-4856	International	4900 6 Wheel Dump	2001	1403 Wst NE	Street and Bridge Wst.
98-6347	International	4900 6 Wheel Dump	2002	1403 Wst NE	Street and Bridge Wst.
98-6927	International	4900 6 Wheel Dump	2001	1403 Wst NE	Street and Bridge Wst.
98-9583	Sterling	LT9500	2003	1403 Wst NE	Street and Bridge Wst.
98-10333	International	4900 6 Wheel Dump	2002	1403 Wst NE	Street and Bridge Wst.
98-7977	Freight Liner	Tractor	2002	1403 Wst NE	Street and Bridge Wst.
98-7797	JCB	Mini Excavator	2008	1403 Wst NE	Street and Bridge Wst.
98-7796	JCB	Back Hoe	2009	1403 Wst NE	Street and Bridge Wst.
98-6298	Cam	Trailer	2007	1403 Wst NE	Street and Bridge Wst.
98-6647	Mack	Mixer	2010	1403 Wst NE	Street and Bridge Wst.
98-6750	Global	Trailer	2009	1403 Wst NE	Street and Bridge Wst.
98-7225	Ingersoll Rand	Compressor	2009	1403 Wst NE	Street and Bridge Wst.
98-7226	Ingersoll Rand	Compressor	2009	1403 Wst NE	Street and Bridge Wst.
98-7227	Ingersoll Rand	Compressor	2009	1403 Wst NE	Street and Bridge Wst.
98-7228	Ingersoll Rand	Compressor	2009	1403 Wst NE	Street and Bridge Wst.
98-5584	Bombardie	Snowplow	1987	1403 Wst NE	Street and Bridge Wst.
98-6028	Komatsu	Loader	2007	1403 Wst NE	Street and Bridge Wst.
98-6029	Komatsu	Loader	2007	1403 Wst NE	Street and Bridge Wst.
98-4534	Trailize	TE100 HT 48	2006	1403 Wst NE	Street and Bridge Wst.
98-4440	Ingersoll Rand	Compressor	1995	1403 Wst NE	Street and Bridge Wst.
98-4438	Ingersoll Rand	Compressor	1995	1403 Wst NE	Street and Bridge Wst.
98-4399	PSI	Trailer	2005	1403 Wst NE	Street and Bridge Wst.
98-3853	Ingersoll Rand	Compressor	1995	1403 Wst NE	Street and Bridge Wst.
HL-1694	Ingersoll Rand	Light Tower	2002	1403 Wst NE	Street and Bridge Wst.
HL-1695	Ingersoll Rand	Light Tower	2002	1403 Wst NE	Street and Bridge Wst.
98-8420	Crafco	Trailer	2011	1403 Wst NE	Street and Bridge Wst.
98-8341	Crafco	Trailer	2011	1403 Wst NE	Street and Bridge Wst.
98-8710	Freight Liner	Road Wizard/Sweeper	2013	1403 Wst NE	Street and Bridge Wst.
98-9558	Ford	F-550	2010	1403 Wst NE	Street and Bridge Wst.





















98-9844	Custom 20	Trailer	1999	1403 Wst NE	Street and Bridge Wst.
98-57PVR	Leeboy 8500B	Paver	2010	1403 Wst NE	Street and Bridge Wst.
98-85PVR	Leeboy 8500B	Paver	2010	1403 Wst NE	Street and Bridge Wst.
98-BW12	Bomag	X	2009	1403 Wst NE	Street and Bridge Wst.
98-CE01	Bomag	BW135AD	1999	1403 Wst NE	Street and Bridge Wst.
98-GL22	GEHL	Loader	2009	1403 Wst NE	Street and Bridge Wst.
98-SL71	Caterpillar	Skidsteer	2001	1403 Wst NE	Street and Bridge Wst.
98-SL06	Caterpillar	Skidsteer	2001	1403 Wst NE	Street and Bridge Wst.
98-7975	Well	Trailer	2011	1403 Wst NE	Street and Bridge Wst.
98-7879	Hudson	HTD18D	1993	1403 Wst NE	Street and Bridge Wst.
98-2921	JCB	Loader Forklift	2004	1403 Wst NE	Street and Bridge Wst.
98-2455	Continental	trailer/Crafco Trailer	2002	1403 Wst NE	Street and Bridge Wst.
98-1734	Kubota	Generator	2002	1403 Wst NE	Street and Bridge Wst.
98-10770	International	7400 10 Wheel Dump	2010	1403 Wst NE	Street and Bridge Wst.
98-2454	Continental	trailer/Crafco Trailer	2002	1403 Wst NE	Street and Bridge Wst.
98-10776	International	7400 10 Wheel Dump	2010	1403 Wst NE	Street and Bridge Wst.
98-2176	Solar Tech	Trailer	2003	1403 Wst NE	Street and Bridge Wst.
98-2337	Solar Tech	Trailer	2003	1403 Wst NE	Street and Bridge Wst.
98-S2110	Ex Mark	BR270KC36 Broom	2015	1735 15th Street NE	Street and Bridge Wst.
98-S2114	Ex Mark	BR270KC36 Broom	2015	1735 15th Street NE	Street and Bridge Wst.
98-0155	Wirtgen	Milling Machine	2002	1403 Wst NE	Street and Bridge Wst.
98-0525	JCB	Loader	2001	1403 Wst NE	Street and Bridge Wst.
98-0540	JCB	Loader	2001	1403 Wst NE	Street and Bridge Wst.
98-0541	JCB	Loader	2001	1403 Wst NE	Street and Bridge Wst.
98-0553	Caterpillar	Loader	2001	1403 Wst NE	Street and Bridge Wst.
98-0554	Caterpillar	430D Loader	2001	1403 Wst NE	Street and Bridge Wst.
98-0555	Caterpillar	430D Loader	2001	1403 Wst NE	Street and Bridge Wst.
98-0820	Trafcon	Trailer	2002	1403 Wst NE	Street and Bridge Wst.
98-0846	Caterpillar	Motorgrader	2002	1403 Wst NE	Street and Bridge Wst.
98-0980	Eager Beaver	Trailer	2002	1403 Wst NE	Street and Bridge Wst.
98-0982	Eager Beaver	Trailer	2002	1403 Wst NE	Street and Bridge Wst.
98-1182	Bomag	BW161AD-2 Roller	2002	1403 Wst NE	Street and Bridge Wst.
98-1183	Bomag	BW161AD-2 Roller	2002	1403 Wst NE	Street and Bridge Wst.
98-1393	Lee Boy Motorgrader	Paver	2003	1403 Wst NE	Street and Bridge Wst.
98-1547	New Holland	LW170	2002	1403 Wst NE	Street and Bridge Wst.
98-170H	Ingersoll Rand	Roller	2005	1403 Wst NE	Street and Bridge Wst.
98-1728	Kubota	Generator	2002	1403 Wst NE	Street and Bridge Wst.
98-1733	Ingersoll Rand	Light Tower	2002	1403 Wst NE	Street and Bridge Wst.
98-1746	Ingersoll Rand	Light Tower	2002	1403 Wst NE	Street and Bridge Wst.
98-10774	Ford	F-550	2008	1403 Wst NE	Street and Bridge Wst.
98-10772	Sterling	SC8000	2003	1403 Wst NE	Street and Bridge Wst.
98-10769	International	4900 6 Wheel Dump	2002	1403 Wst NE	Street and Bridge Wst.
98-10414	Ford	F-350	2014	1403 Wst NE	Street and Bridge Wst.
98-10416	Ford	F-350	2014	1403 Wst NE	Street and Bridge Wst.
98-10777	International	7400 10 Wheel Dump	2010	1403 Wst NE	Street and Bridge Wst.
98-10778	International	7600SFA 10 Wheel Dump	2008	1403 Wst NE	Street and Bridge Wst.
98-10779	International	4900 6 Wheel Dump	2002	1403 Wst NE	Street and Bridge Wst.
98-10780	Ford	F-550	2008	1403 Wst NE	Street and Bridge Wst.
98-10782	Ford	F-550	2008	1403 Wst NE	Street and Bridge Wst.
98-10843	Ford	F-550	2008	1403 Wst NE	Street and Bridge Wst.
98-11010	Ford	F-550	2009	1403 Wst NE	Street and Bridge Wst.
98-10765	International	4900 6 Wheel Dump	2001	1403 Wst NE	Street and Bridge Wst.
98-10767	International	7400 10 Wheel Dump	2010	1403 Wst NE	Street and Bridge Wst.
98-10768	International	7400 10 Wheel Dump	2010	1403 Wst NE	Street and Bridge Wst.
98-9980	Ford	F-550	2008	1403 Wst NE	Street and Bridge Wst.
98-10128	Sterling	SC8000	2002	1403 Wst NE	Street and Bridge Wst.
98-10231	International	7400 10 Wheel Dump	2010	1403 Wst NE	Street and Bridge Wst.
98-10241	Toyota	Tacoma	2013	1403 Wst NE	Street and Bridge Wst.
98-10413	Ford	F-350	2014	1403 Wst NE	Street and Bridge Wst.
98-9615	International	4900 6 Wheel Dump-Crash Cus	2001	1403 Wst NE	Street and Bridge Wst.
98-9614	International	7400 10 Wheel Dump	2010	1403 Wst NE	Street and Bridge Wst.
98-9585	Ford	F-550	2008	1403 Wst NE	Street and Bridge Wst.
98-9578	International	4900 6 Wheel Dump	2001	1403 Wst NE	Street and Bridge Wst.
98-9559	International	7600SFA 10 Wheel Dump	2008	1403 Wst NE	Street and Bridge Wst.
98-9561	International	7400 10 Wheel Dump	2010	1403 Wst NE	Street and Bridge Wst.
98-9553	International	7400 Tac Truck	2002	1403 Wst NE	Street and Bridge Wst.
98-8386	International	7400 6 Wheel Dump	2009	1403 Wst NE	Street and Bridge Wst.
98-8395	International	4900 6 Wheel Dump	2002	1403 Wst NE	Street and Bridge Wst.
98-8441	Sterling	LT9500	2003	1403 Wst NE	Street and Bridge Wst.
98-8553	114 SD	Frightliner	2015	1403 Wst NE	Street and Bridge Wst.
98-8385	Ford	F-550	2008	1403 Wst NE	Street and Bridge Wst.
98-8286	Chevrolet	F-150	2012	1403 Wst NE	Street and Bridge Wst.
98-8327	Freight Liner	M2106V 6 Wheel Dump	2012	1403 Wst NE	Street and Bridge Wst.
98-8232	Chevrolet	Silverado	2012	1403 Wst NE	Street and Bridge Wst.
98-8184	Ford	F-550	2008	1403 Wst NE	Street and Bridge Wst.
98-7625	International	4900 6 Wheel Dump	2002	1403 Wst NE	Street and Bridge Wst.
98-7723	Ford	F-550	2008	1403 Wst NE	Street and Bridge Wst.
98-7594	Sterling	SC8000	2003	1403 Wst NE	Street and Bridge Wst.
98-7414	Ford	F-550	2010	1403 Wst NE	Street and Bridge Wst.
98-7370	Sterling	Stakebody	2003	1403 Wst NE	Street and Bridge Wst.
98-7413	Ford	F-550	2010	1403 Wst NE	Street and Bridge Wst.
98-7367	International	4900 6 Wheel Dump	2002	1403 Wst NE	Street and Bridge Wst.
98-7137	Ford	F-550	2008	1403 Wst NE	Street and Bridge Wst.
98-7125	Ford	F-550	2008	1403 Wst NE	Street and Bridge Wst.
98-7081	Ford	F-550	2008	1403 Wst NE	Street and Bridge Wst.
98-7104	Ford	F-550	2008	1403 Wst NE	Street and Bridge Wst.
98-7079	Ford	F-550	2008	1403 Wst NE	Street and Bridge Wst.

98-6934	International	4700 6 Wheel Dump	2001	1403 Wst NE	Street and Bridge Wst.
98-7078	Ford	F-550	2008	1403 Wst NE	Street and Bridge Wst.
98-5685	Ford	F-550	2008	1403 Wst NE	Street and Bridge Wst.
98-4909	International	7400 6 Wheel Dump	2008	1403 Wst NE	Street and Bridge Wst.
98-4946	International	7600SFA 10 Wheel Dump	2008	1403 Wst NE	Street and Bridge Wst.
98-4905	Ford	F-350	2008	1403 Wst NE	Street and Bridge Wst.
98-4906	Ford	F-350	2008	1403 Wst NE	Street and Bridge Wst.
98-0157	Ford	Step Van	2001	1403 Wst NE	Street and Bridge Wst.
98-0353	GMC	TC2000 Street Flusher	1998	1403 Wst NE	Street and Bridge Wst.
98-0377	Mercedes	Unimog	1986	1403 Wst NE	Street and Bridge Wst.
98-1281	International	4300SBA 4x2 Utility Truck	2003	1403 Wst NE	Street and Bridge Wst.
98-1463	Ford	F-550 Welding Truck	2004	1403 Wst NE	Street and Bridge Wst.
98-1730	International	7400 Tar Patch 4x4	2002	1403 Wst NE	Street and Bridge Wst.
98-1731	International	7400 Tar Patch 4x4	2002	1403 Wst NE	Street and Bridge Wst.
98-1732	International	7400 Tar Patch 4x4	2002	1403 Wst NE	Street and Bridge Wst.
98-2339	International	Sweeper	2003	1403 Wst NE	Street and Bridge Wst.
98-2419	Chevrolet	S-10 Pickup	2003	1403 Wst NE	Street and Bridge Wst.
98-2420	Chevrolet	S-10 Pickup	2003	1403 Wst NE	Street and Bridge Wst.
98-2568	Chevrolet	Pickup Truck	2003	1403 Wst NE	Street and Bridge Wst.
98-2572	Chevrolet	Pickup Truck	2003	1403 Wst NE	Street and Bridge Wst.
98-4096	Volvo	Tractor	2006	1403 Wst NE	Street and Bridge Wst.
98-4543	International	2654 6x4 10 Wheel Dump	2000	1403 Wst NE	Street and Bridge Wst.
98-4861	International	4900 6 Wheel Dump-Crash Cus	2001	1403 Wst NE	Street and Bridge Wst.
98-4870	Ford	Ranger Pickup	2008	1403 Wst NE	Street and Bridge Wst.
98-4883	Ford	F-350	2008	1403 Wst NE	Street and Bridge Wst.
98-4888	Ford	F-350	2008	1403 Wst NE	Street and Bridge Wst.
98-4889	Ford	F-350	2008	1403 Wst NE	Street and Bridge Wst.
98-4902	Ford	Ranger Pickup	2008	1403 Wst NE	Street and Bridge Wst.
98-4903	Ford	F-350	2008	1403 Wst NE	Street and Bridge Wst.
98-4904	Ford	F-350	2008	1403 Wst NE	Street and Bridge Wst.
98-0134	Ford	Utility Truck	2001	414 Farragut St. NE	Street and Bridge Farragut St.
98-2815	International	Ariel Truck	2000	414 Farragut St. NE	Street and Bridge Farragut St.
98-10553	Toyota	Tacoma	2015	414 Farragut St. NE	Street and Bridge Farragut St.
98-2178	Volvo	Flusher Truck	2003	414 Farragut St. NE	Street and Bridge Farragut St.
98-2816	International	4700 6 Wheel Dump	2000	414 Farragut St. NE	Street and Bridge Farragut St.
98-10568	GMC	C8500 6 Wheel Dump Tanker	1998	414 Farragut St. NE	Street and Bridge Farragut St.
98-2820	GMC	C8500 6 Wheel Dump	1998	414 Farragut St. NE	Street and Bridge Farragut St.
98-3992	International	2554 4x2 6 Wheel Dump	1997	414 Farragut St. NE	Street and Bridge Farragut St.
98-4907	International	7400 6 Wheel Dump	2008	414 Farragut St. NE	Street and Bridge Farragut St.
98-4908	International	7400 6 Wheel Dump	2008	414 Farragut St. NE	Street and Bridge Farragut St.
98-4910	International	7400 6 Wheel Dump	2008	414 Farragut St. NE	Street and Bridge Farragut St.
98-4915	Ford	F-350	2008	414 Farragut St. NE	Street and Bridge Farragut St.
98-4916	Ford	F-350	2008	414 Farragut St. NE	Street and Bridge Farragut St.
98-6929	Freight Liner	Step Van	2001	414 Farragut St. NE	Street and Bridge Farragut St.
98-7123	Ford	F-550	2008	414 Farragut St. NE	Street and Bridge Farragut St.
98-7124	Ford	F-550	2008	414 Farragut St. NE	Street and Bridge Farragut St.
98-7126	Ford	F-550	2008	414 Farragut St. NE	Street and Bridge Farragut St.
98-7141	Ford	F-350	2008	414 Farragut St. NE	Street and Bridge Farragut St.
98-7267	International	4900 6 Wheel Dump	2001	414 Farragut St. NE	Street and Bridge Farragut St.
98-7368	International	4900 6 Wheel Dump	2002	414 Farragut St. NE	Street and Bridge Farragut St.
98-7415	Ford	F-550	2010	414 Farragut St. NE	Street and Bridge Farragut St.
98-7742	Chevrolet	3500	2001	414 Farragut St. NE	Street and Bridge Farragut St.
98-7933	International	7600SFA 10 Wheel Dump	2008	414 Farragut St. NE	Street and Bridge Farragut St.
98-8233	Chevrolet	Silverado	2012	414 Farragut St. NE	Street and Bridge Farragut St.
98-8298	Freight Liner	M2106V 6 Wheel Dump	2012	414 Farragut St. NE	Street and Bridge Farragut St.
98-8300	Freight Liner	M2106V 6 Wheel Dump	2012	414 Farragut St. NE	Street and Bridge Farragut St.
98-8301	Freight Liner	M2106V 6 Wheel Dump	2012	414 Farragut St. NE	Street and Bridge Farragut St.
98-8302	Freight Liner	M2106V 6 Wheel Dump	2012	414 Farragut St. NE	Street and Bridge Farragut St.
98-8303	Freight Liner	M2106V 6 Wheel Dump	2012	414 Farragut St. NE	Street and Bridge Farragut St.
98-8304	Freight Liner	M2106V 6 Wheel Dump	2012	414 Farragut St. NE	Street and Bridge Farragut St.
98-8323	Ford	F-150	2012	414 Farragut St. NE	Street and Bridge Farragut St.
98-8328	Freight Liner	M2106V 6 Wheel Dump	2012	414 Farragut St. NE	Street and Bridge Farragut St.
98-8329	Freight Liner	M2106V 6 Wheel Dump	2012	414 Farragut St. NE	Street and Bridge Farragut St.
98-8402	GMC	C8000	1998	414 Farragut St. NE	Street and Bridge Farragut St.
98-8439	International	7400 6 Wheel Dump	2009	414 Farragut St. NE	Street and Bridge Farragut St.
98-8442	Ford	F-550	2008	414 Farragut St. NE	Street and Bridge Farragut St.
98-8443	International	7400 6 Wheel Dump	2009	414 Farragut St. NE	Street and Bridge Farragut St.
98-8661	Freight Liner	M2106V 6 Wheel Dump	2012	414 Farragut St. NE	Street and Bridge Farragut St.
98-8657	Freight Liner	M2106V 6 Wheel Dump	2012	414 Farragut St. NE	Street and Bridge Farragut St.
98-8658	Freight Liner	M2106V 6 Wheel Dump	2012	414 Farragut St. NE	Street and Bridge Farragut St.
98-8659	Freight Liner	M2106V 6 Wheel Dump	2012	414 Farragut St. NE	Street and Bridge Farragut St.
98-8660	Freight Liner	M2106V 6 Wheel Dump	2012	414 Farragut St. NE	Street and Bridge Farragut St.
98-8677	Freight Liner	M2106V 6 Wheel Dump	2012	414 Farragut St. NE	Street and Bridge Farragut St.
98-9550	International	4900 6 Wheel Dump	2001	414 Farragut St. NE	Street and Bridge Farragut St.
98-10771	International	7400 6 Wheel Dump	2009	414 Farragut St. NE	Street and Bridge Farragut St.
98-10773	International	7400 6 Wheel Dump	2009	414 Farragut St. NE	Street and Bridge Farragut St.
98-10775	International	4900 6 Wheel Dump	2001	414 Farragut St. NE	Street and Bridge Farragut St.
98-10781	International	7400 6 Wheel Dump	2009	414 Farragut St. NE	Street and Bridge Farragut St.
98-9167	International	7400 6 Wheel Dump	2009	414 Farragut St. NE	Street and Bridge Farragut St.
98-9198	International	7400 6 Wheel Dump	2009	414 Farragut St. NE	Street and Bridge Farragut St.
98-9223	International	7400 6 Wheel Dump	2009	414 Farragut St. NE	Street and Bridge Farragut St.
98-9551	Ford	F-550	2008	414 Farragut St. NE	Street and Bridge Farragut St.
98-9552	International	4900 6 Wheel Dump	2001	414 Farragut St. NE	Street and Bridge Farragut St.
98-9584	Ford	F-550	2008	414 Farragut St. NE	Street and Bridge Farragut St.
98-9669	Peterbilt	Flusher Truck	2013	414 Farragut St. NE	Street and Bridge Farragut St.
98-10766	International	7400 6 Wheel Dump	2009	414 Farragut St. NE	Street and Bridge Farragut St.
98-47H5	Elgin	Crane	1985	414 Farragut St. NE	Street and Bridge Farragut St.

98-6030	Komatsu	Loader	2007	414 Farragut St. NE	Street and Bridge Farragut St.
98-6031	Komatsu	Loader	2007	414 Farragut St. NE	Street and Bridge Farragut St.
98-2826	International	4900 6 Wheel Dump	2001	414 Farragut St. NE	Street and Bridge Farragut St.
98-2827	International	4900 6 Wheel Dump	2001	414 Farragut St. NE	Street and Bridge Farragut St.
98-6930	International	4900 6 Wheel Dump	2001	414 Farragut St. NE	Street and Bridge Farragut St.
98-7587	International	4900 6 Wheel Dump	2001	414 Farragut St. NE	Street and Bridge Farragut St.
98-8512	International	4900 6 Wheel Dump	2001	414 Farragut St. NE	Street and Bridge Farragut St.
98-9577	International	4900 6 Wheel Dump	2001	414 Farragut St. NE	Street and Bridge Farragut St.
98-9579	International	4900 6 Wheel Dump	2002	414 Farragut St. NE	Street and Bridge Farragut St.
98-2448	Honda	Civic	2003	414 Farragut St. NE	Street and Bridge Farragut St.
98-2417	Chevrolet	S-10 Pickup	2003	414 Farragut St. NE	Street and Bridge Farragut St.
98-4871	Ford	Ranger Pickup	2008	414 Farragut St. NE	Street and Bridge Farragut St.
98-0135	Ford	F-250	2001	1338 Rear G St. SE	Information Technology System Support Division
98-2415	Chevrolet	S-10 Pickup	2003	1338 Rear G St. SE	Information Technology System Support Division
98-2732	Ford	F-450 Lift	2001	1338 Rear G St. SE	Information Technology System Support Division
98-4288	Ford	Bucket Truck	2005	1338 Rear G St. SE	Information Technology System Support Division
98-7903	Ford	E-350	2010	1338 Rear G St. SE	Information Technology System Support Division
98-4328	Ford	Bucket Truck	2000	1338 Rear G St. SE	Information Technology System Support Division
98-4289	Ford	Bucket Truck	2005	1338 Rear G St. SE	Information Technology System Support Division
98-1113	Smart	Trailer	2001	1735 15th Street NE	Information Technology System Support Division
98-1115	Smart	Trailer	2001	1735 15th Street NE	Information Technology System Support Division
98-1116	Smart	Trailer	2001	1735 15th Street NE	Information Technology System Support Division
98-1118	Smart	Trailer	2001	1735 15th Street NE	Information Technology System Support Division
98-8653	Smart	Trailer	2001	1735 15th Street NE	Information Technology System Support Division
98-8662	Smart	Trailer	2001	1735 15th Street NE	Information Technology System Support Division
98-2325	Radar	Trailer	1998	1735 15th Street NE	Information Technology System Support Division
98-2326	Radar	Trailer	1998	1735 15th Street NE	Information Technology System Support Division
98-6751	RU2	850 Speed Ranger	2009	1735 15th Street NE	Information Technology System Support Division
98-6752	RU2	850 Speed Ranger	2009	1735 15th Street NE	Information Technology System Support Division
98-6753	RU2	850 Speed Ranger	2009	1735 15th Street NE	Information Technology System Support Division
98-6754	RU2	850 Speed Ranger	2009	1735 15th Street NE	Information Technology System Support Division
98-6755	RU2	850 Speed Ranger	2009	1735 15th Street NE	Information Technology System Support Division
98-06003	Cub-20	EU3000	2006	1735 15th Street NE	Information Technology System Support Division
98-06005	Cub-20	EU3000	2006	1735 15th Street NE	Information Technology System Support Division
98-06012	Cub-20	EU3000	2006	1735 15th Street NE	Information Technology System Support Division
98-06031	Cub-20	EU3000	2006	1735 15th Street NE	Information Technology System Support Division
98-06070	Cub-20	EU3000	2006	1735 15th Street NE	Information Technology System Support Division
98-06071	Cub-20	EU3000	2006	1735 15th Street NE	Information Technology System Support Division
98-06106	Cub-20	EU3000	2006	1735 15th Street NE	Information Technology System Support Division
98-06110	Cub-20	EU3000	2006	1735 15th Street NE	Information Technology System Support Division
98-06111	Cub-20	EU3000	2006	1735 15th Street NE	Information Technology System Support Division
98-06112	Cub-20	EU3000	2006	1735 15th Street NE	Information Technology System Support Division
98-06185	Cub-20	EU3000	2006	1735 15th Street NE	Information Technology System Support Division
98-06189	Cub-20	EU3000	2006	1735 15th Street NE	Information Technology System Support Division
98-06190	Cub-20	EU3000	2006	1735 15th Street NE	Information Technology System Support Division
98-06192	Cub-20	EU3000	2006	1735 15th Street NE	Information Technology System Support Division
98-3359	Ford	Econoline	1999	1338 Rear G St. SE	Information Technology System Support Division
98-0137	Ford	F-250	2001	1338 Rear G St. SE	Information Technology System Support Division
98-2421	Chevrolet	S-10 Pickup	2003	1338 Rear G St. SE	Information Technology System Support Division
98-1018	Ford	Van	2002	1735 15th Street NE	Information Technology System Support Division
98-10245	Toyota	Tacoma	2013	1338 Rear G St. SE	Information Technology System Support Division
98-10244	Toyota	Tacoma	2013	1338 Rear G St. SE	Information Technology System Support Division
98-9365	Chevrolet	Silverado	2012	1338 Rear G St. SE	Information Technology System Support Division
98-10242	Toyota	Tacoma	2013	1338 Rear G St. SE	Information Technology System Support Division
98-7904	Ford	E-350	2010	1338 Rear G St. SE	Information Technology System Support Division
98-0975	Ford	Expedition	2001	2000 14th St. (Reeves Ctr.)	Information Technology System Support Division
98-4287	Ford	Expedition	2001	1735 15th Street NE	Information Technology System Support Division
98-4552	Chevrolet	1500 Pickup	2002	1735 15th Street NE	Information Technology System Support Division
98-4553	Ford	F-450 Lift	2001	1735 15th Street NE	Information Technology System Support Division
98-4554	Chevrolet	Express Van	2003	1735 15th Street NE	Information Technology System Support Division
98-4555	Chevrolet	Express Van	2003	1735 15th Street NE	Information Technology System Support Division
98-4556	Ford	F-550 Bucket Truck	2003	1735 15th Street NE	Information Technology System Support Division
98-8282	Ford	F-150	2012	1735 15th Street NE	Information Technology System Support Division
98-9610	Chevrolet	Express Van	2013	1735 15th Street NE	Information Technology System Support Division
98-9611	Chevrolet	Express Van	2013	1735 15th Street NE	Information Technology System Support Division
98-10243	Toyota	Tacoma	2013	2000 14th St. (Reeves Ctr.)	Information Technology System Support Division
98-7433	Solar Tech	Solar Trailer	2009	Reno Rd N.W	Information Technology System Support Division
98-7434	Solar Tech	Solar Trailer	2009	Reno Rd N.W	Information Technology System Support Division
98-7435	Solar Tech	Solar Trailer	2009	Reno Rd N.W	Information Technology System Support Division
98-7436	Solar Tech	Solar Trailer	2009	Reno Rd N.W	Information Technology System Support Division
98-7437	Solar Tech	Solar Trailer	2009	Reno Rd N.W	Information Technology System Support Division
98-7438	Solar Tech	Solar Trailer	2009	Reno Rd N.W	Information Technology System Support Division
98-7439	Solar Tech	Solar Trailer	2009	Reno Rd N.W	Information Technology System Support Division
98-7440	Solar Tech	Solar Trailer	2009	Reno Rd N.W	Information Technology System Support Division
98-7441	Solar Tech	Solar Trailer	2009	Reno Rd N.W	Information Technology System Support Division
98-7442	Solar Tech	Solar Trailer	2009	Reno Rd N.W	Information Technology System Support Division
98-7551	Solar Tech	Solar Trailer	2009	Reno Rd N.W	Information Technology System Support Division
98-7752	Solar Tech	Solar Trailer	2009	Reno Rd N.W	Information Technology System Support Division
98-11263	Dodge	RAM ST 4x4 1500	2015	1735 15th Street NE	Information Technology System Support Division
98-11199	Dodge	1500 Pickup	2015	1338 Rear G St. SE	ITS & Traffic Signs Safety Standards
98-2733	Chevrolet	Blazer	2002	55 M St. SE	ITS & Traffic Signs Safety Standards
98-8324	Ford	F-150	2012	55 M St. SE	ITS & Traffic Signs Safety Standards
98-8342	Ford	F-150 4x4	2012	55 M St. SE	ITS & Traffic Signs Safety Standards
98-10370	Dodge	Grand Caravan	2014	55 M St. SE	ITS & Traffic Signs Safety Standards
98-10251	Dodge	Grand Caravan	2014	2000 14th St. (Reeves Ctr.)	School Crossing Guards Division
98-10835	Toyota	Corolla LE	2015	2000 14th St. (Reeves Ctr.)	School Crossing Guards Division
98-4868	Ford	Ranger Pickup	2008	2000 14th St. (Reeves Ctr.)	School Crossing Guards Division

98-4873	Ford	Ranger Pickup	2008	2000 14th St. (Reeves Ctr.)	School Crossing Guards Division
98-4884	Ford	Ranger Pickup	2008	2000 14th St. (Reeves Ctr.)	School Crossing Guards Division
98-10155	Toyota	Corolla LE	2013	2000 14th St. (Reeves Ctr.)	School Crossing Guards Division
98-10156	Toyota	Corolla LE	2013	2000 14th St. (Reeves Ctr.)	School Crossing Guards Division
98-10696	Toyota	Tacoma	2015	55 M St. SE	Citywide Division
98-10711	Toyota	Tacoma	2015	55 M St. SE	Citywide Division
98-4887	Ford	Ranger Pickup	2008	55 M St. SE	Citywide Division
98-7870	Chevrolet	Silverado	2011	55 M St. SE	Citywide Division
98-8295	Ford	F-150	2012	55 M St. SE	Citywide Division
98-8296	Ford	F-150	2012	55 M St. SE	Citywide Division
98-8297	Ford	F-150	2012	55 M St. SE	Citywide Division
98-8338	Ford	F-150 4x4	2012	55 M St. SE	Citywide Division
98-8531	Chevrolet	T8500	2002	55 M St. SE	Citywide Division
98-4885	Ford	Ranger Pickup	2008	55 M St. SE	Citywide Division
98-2416	Chevrolet	S-10 Pickup	2003	55 M St. SE	Citywide Division
98-2848	Chevrolet	Silverado LS	2001	1403 Wst NE	Urban Forestry Administration
98-2543	Chevrolet	Pick-up	2003	1403 Wst NE	Urban Forestry Administration
98-8061	Toyota	Tacoma	2014	55 M St. SE	Urban Forestry Administration
98-8062	Toyota	Tacoma	2014	55 M St. SE	Urban Forestry Administration
98-8060	Toyota	Tacoma	2014	55 M St. SE	Urban Forestry Administration
98-4869	Ford	Ranger Pickup	2007	55 M St. SE	Urban Forestry Administration
98-6349	Ford	Ranger Pickup	2008	55 M St. SE	Urban Forestry Administration
98-6628	Honda	Civic Hybrid	2009	55 M St. SE	Urban Forestry Administration
98-7741	Ford	F-150	2008	55 M St. SE	Urban Forestry Administration
98-8283	Ford	F-150	2012	55 M St. SE	Urban Forestry Administration
98-8284	Ford	F-150	2012	55 M St. SE	Urban Forestry Administration
98-8285	Ford	F-150	2012	55 M St. SE	Urban Forestry Administration
98-8346	Ford	F-150	2012	55 M St. SE	Urban Forestry Administration
98-8656	Ford	F-150	2012	55 M St. SE	Urban Forestry Administration
98-9367	Toyota	Corolla LE	2013	55 M St. SE	Urban Forestry Administration
98-9378	Toyota	Corolla LE	2013	55 M St. SE	Urban Forestry Administration
98-10157	Toyota	Corolla LE	2013	55 M St. SE	Urban Forestry Administration
98-0869	Sterling	M7500	2002	1403 Wst NE	Urban Forestry Administration
98-0912	Chevrolet	Bucket Truck	2002	1403 Wst NE	Urban Forestry Administration
98-0987	GMC	T8500	2002	1403 Wst NE	Urban Forestry Administration
98-1068	International	Bucket Truck	2002	1403 Wst NE	Urban Forestry Administration
98-2847	GMC	T8500	2002	1403 Wst NE	Urban Forestry Administration
98-3356	GMC	T8500	2001	1403 Wst NE	Urban Forestry Administration
98-3823	Sterling	LT9500	2005	1403 Wst NE	Urban Forestry Administration
98-9355	Chevrolet	Silverado	2012	1403 Wst NE	Urban Forestry Administration
98-7242	Sterling	Bucket Truck	2008	1403 Wst NE	Urban Forestry Administration
98-7810	Ultimate Diesel	Hawk H1150	2009	1403 Wst NE	Urban Forestry Administration
98-7814	Ultimate Diesel	Hawk H1150	2009	1403 Wst NE	Urban Forestry Administration
98-7819	GMC	T8500	1999	1403 Wst NE	Urban Forestry Administration
98-8369	Ford	F-350	2011	1403 Wst NE	Urban Forestry Administration
98-10676	Toyota	Tacoma	2015	1403 Wst NE	Urban Forestry Administration
98-0523	JCB	Loader	2001	1403 Wst NE	Urban Forestry Administration
98-1977	Vermeer	Stump Grinder	2002	1403 Wst NE	Urban Forestry Administration
98-6545	Vermeer	Chipper	2008	1403 Wst NE	Urban Forestry Administration
98-6729	Vermeer	Chipper	2009	1403 Wst NE	Urban Forestry Administration
98-6730	Vermeer	Chipper	2009	1403 Wst NE	Urban Forestry Administration
98-7465	Vermeer	Chipper	2008	1403 Wst NE	Urban Forestry Administration
98-7821	Vermeer	Chipper	2006	1403 Wst NE	Urban Forestry Administration
98-9522	Bobcat	Blazer	2012	1403 Wst NE	Urban Forestry Administration
98-8240	Chevrolet	Volt	2012	55 M St. SE	Progressive Transportation Services Admin
98-8294	Chevrolet	Volt	2012	55 M St. SE	Progressive Transportation Services Admin
98-10158	Toyota	Corolla LE	2013	55 M St. SE	Progressive Transportation Services Admin
98-10194	Chevrolet	Silverado 1500	2014	55 M St. SE	Progressive Transportation Services Admin
98-Snw02	Snow	Blower	2015	1735 15th Street NE	Fleet Management
98-Snw03	Snow	Blower	2015	1735 15th Street NE	Fleet Management
98-Snw05	Snow	Blower	2015	1735 15th Street NE	Fleet Management
98-Snw06	Snow	Blower	2015	1735 15th Street NE	Fleet Management
98-Snw07	Snow	Blower	2015	1735 15th Street NE	Fleet Management
98-Y782N	Yale	Forklift	2014	1735 15th Street NE	Fleet Management
98-Snw01	Snow	Blower	2015	1735 15th Street NE	Fleet Management
98-Snw04	Snow	Blower	2015	1735 15th Street NE	Fleet Management
98-4867	Ford	Ranger Pickup	2008	1735 15th Street NE	Fleet Management
98-10208	Ford	E 350 15 Passenger Van	2013	1735 15th Street NE	Fleet Management
98-8325	Ford	F-150 4x4	2012	1735 15th Street NE	Fleet Management
98-MT3771	Yamaha	Motorcycle	2012	1735 15th Street NE	Fleet Management
98-MT3772	Yamaha	Motorcycle	2012	1735 15th Street NE	Fleet Management
98-MT3773	Yamaha	Motorcycle	2012	1735 15th Street NE	Fleet Management
98-MT3774	Yamaha	Motorcycle	2012	1735 15th Street NE	Fleet Management
98-3776	VCTX	Vectrix VX2	2012	1735 15th Street NE	Fleet Management
98-3777	VCTX	Vectrix VX2	2012	1735 15th Street NE	Fleet Management
98-3778	VCTX	Vectrix VX2	2012	1735 15th Street NE	Fleet Management
98-3779	VCTX	Vectrix VX2	2012	1735 15th Street NE	Fleet Management
98-2167	Tennant	Scubber	2004	1735 15th Street NE	Fleet Management
98-766K	Yale	GP050VX	2012	1735 15th Street NE	Fleet Management
98-8241	Chevrolet	Volt	2012	55 M St. SE	TST Division
98-8293	Chevrolet	Volt	2012	55 M St. SE	TST Division
98-9795	Toyota	Tacoma	2013	55 M St. SE	TST Division
98-9796	Toyota	Tacoma	2013	55 M St. SE	TST Division
98-9845	Toyota	Tacoma	2013	55 M St. SE	TST Division
98-9848	Toyota	Tacoma	2013	55 M St. SE	TST Division
98-10238	Toyota	Tacoma	2013	55 M St. SE	TST Division







Administration (Division)	License Plate	Year/Make/Model	Leased/Owned	Location	
PSRA (SIOD)					
KA6000-DDOT, Public Space Regulatory Admin	98-2418	2003 Chevrolet S-10 Pickup	Owned	55 M st SE	
KA6000-DDOT, Public Space Regulatory Admin	98-2505	2003 Chevrolet C2500 Pickup	Owned	55 M st SE	
KA6000-DDOT, Public Space Regulatory Admin	98-2510	2003 Chevrolet C2500 Pickup	Owned	55 M st SE	
KA6000-DDOT, Public Space Regulatory Admin	98-4876	2008 Ford Ranger Pickup	Owned	55 M st SE	
KA6000-DDOT, Public Space Regulatory Admin	98-4877	2008 Ford Ranger Pickup	Owned	55 M st SE	
KA6000-DDOT, Public Space Regulatory Admin	98-4878	2008 Ford Ranger Pickup	Owned	55 M st SE	
KA6040-DDOT, Public Space Regulatory Admin	98-4879	2001 Ford Ranger Pickup	Owned	2000 14th st (Reeves ctr)	
KA6000-DDOT, Public Space Regulatory Admin	98-4866	2008 Ford Ranger Pickup	Owned	1100 4th st SW	
KA6000-DDOT, Public Space Regulatory Admin	98-4901	2008 Ford Ranger Pickup	Owned	55 M st SE	
KA6000-DDOT, Public Space Regulatory Admin	98-4921	2009 Ford Ranger Pickup	Owned	55 M st SE	
KA6000-DDOT, Public Space Regulatory Admin	98-4922	2008 Ford Ranger Pickup	Owned	55 M st SE	
KA6000-DDOT, Public Space Regulatory Admin	98-6350	2008 Ford Ranger Pickup	Owned	55 M st SE	
KA6000-DDOT, Public Space Regulatory Admin	98-7869	2011 Chevrolet C2500 Pickup	Owned	55 M st SE	
KA6000-DDOT, Public Space Regulatory Admin	98-8326	2012 Ford F-150	Owned	55 M st SE	
KA6000-DDOT, Public Space Regulatory Admin	98-8335	2012 Ford F-150	Owned	55 M st SE	
KA6000-DDOT, Public Space Regulatory Admin	98-8336	2012 Ford F-150	Owned	55 M st SE	
KA6000-DDOT, Public Space Regulatory Admin	98-8654	2012 Ford F-150	Owned	55 M st SE	
KA6000-DDOT, Public Space Regulatory Admin	98-8828	2014 Dodge Grand Caravan	Owned	56 M st SE	
KA6000-DDOT, Public Space Regulatory Admin	98-10237	2013 Toyota Tacoma	Owned	55 M st SE	
KA6000-DDOT, Public Space Regulatory Admin	98-10297	2013 Dodge Ram 1500 SLT	Leased	55 M st SE	
KA6000-DDOT, Public Space Regulatory Admin	98-10554	2015 Toyota Tacoma	Owned	55 M st SE	
KA6000-DDOT, Public Space Regulatory Admin	98-10714	2015 Toyota Tacoma	Owned	55 M st SE	
KA6000-DDOT, Public Space Regulatory Admin	98-10719	2015 Toyota Tacoma	Owned	55 M st SE	
PSRA (SIOD)					
KA6000-DDOT, Public Space Regulatory Admin	98-1074	2002 Chevrolet S-10 Pickup	Owned	1100 4th st SW	
KA6000-DDOT, Public Space Regulatory Admin	98-2759	2001 Ford Focus	Owned	1100 4th st SW	
KA6000-DDOT, Public Space Regulatory Admin	98-4880	2008 Ford Ranger Pickup	Owned	55 M st SE	
KA6000-DDOT, Public Space Regulatory Admin	98-4881	2008 Ford Ranger Pickup	Owned	55 M st SE	
KA6000-DDOT, Public Space Regulatory Admin	98-4886	2008 Ford Ranger Pickup	Owned	1100 4th st SW	
KA6000-DDOT, Public Space Regulatory Admin	98-7149	2008 Ford Ranger Pickup	Owned	1100 4th st SW	
OD					
KA6001 -DDOT, Office of The Director	98-0142	2001 Ford F-250	Owned	1338 Rear G st SE	
KA6001 -DDOT, Office of The Director	98-2411	2003 Chevrolet S-10 Pickup	Owned	55 M st SE	
KA6001 -DDOT, Office of The Director	98-10660	2014 Dodge Grand Caravan	Owned	55 M st SE	
KA6001 -DDOT, Office of The Director	98-9689	2013 Dodge Caravan SE	Leased	55 M st SE	
KA6001 -DDOT, Office of The Director	98-6104	2007 Chevrolet Suburban	Owned	55 M st SE	
KA6001 -DDOT, Office of The Director	98-6757	2009 Chevrolet Impala	Owned	55 M st SE	
KA6001 -DDOT, Office of The Director	98-7638	2011 Ford Escape Hybrid	Owned	55 M st SE	
KA6001 -DDOT, Office of The Director	98-8240	2012 Chevrolet Volt	Owned	55 M st SE	
KA6001 -DDOT, Office of The Director	98-8241	2012 Chevrolet Volt	Owned	55 M st SE	
KA6001 -DDOT, Office of The Director	98-8337	2012 Ford F-150	Owned	1338 Rear G st SE	
KA6001-DDOT, Office of The Director	98-9797	2013 Toyota Tacoma	Leased	55 M st SE	
KA6001-DDOT, Office of The Director	98-10240	2013 Toyota Tacoma	Owned	55 M st SE	
TOA (FOD)					
KA6010-DDOT, Field Operation Division	98-0216	2000 International Stake body Truck	Owned	1338 Rear G st SE	
KA6010-DDOT, Field Operation Division	98-2815	2000 International 4700	Owned	1338 Rear G st SE	
KA6010-DDOT, Field Operation Division	98-2832	2001 Chevrolet Silverado LS	Owned	1338 Rear G st SE	
KA6010-DDOT, Field Operation Division	98-2838	2001 Chevrolet 4x4 Pickup	Owned	1338 Rear G st SE	
KA6010-DDOT, Field Operation Division	98-3824	2004 Ford Bucket Truck	Owned	1338 Rear G st SE	
KA6010-DDOT, Field Operation Division	98-3865	2004 Ford Bucket Truck	Owned	1338 Rear G st SE	
KA6010-DDOT, Field Operation Division	98-3957	2005 Ford F-550	Owned	1338 Rear G st SE	
KA6010-DDOT, Field Operation Division	98-3959	2005 Ford Bucket Truck	Owned	1338 Rear G st SE	

KA6061-DDOT, Roadway Operations Patrol	98-4789		2006 Ford F-450 Tow Truck	Owned	1735 15th Street NE	
KA6061-DDOT, Roadway Operations Patrol	98-7345		2009 Ford F-550 Tow Truck	Owned	1735 15th Street NE	
KA6061-DDOT, Roadway Operations Patrol	98-7346		2009 Ford F-550 Tow Truck	Owned	1735 15th Street NE	
KA6061-DDOT, Roadway Operations Patrol	98-7739		2011 Chevrolet Duramax	Owned	1735 15th Street NE	
KA6061-DDOT, Roadway Operations Patrol	98-7740		2011 Chevrolet Duramax	Owned	1735 15th Street NE	
KA6061-DDOT, Roadway Operations Patrol	98-8763		2012 Ford F-150	Owned	1735 15th Street NE	
KA6061-DDOT, Roadway Operations Patrol	98-8288		2012 Ford F-150	Owned	1735 15th Street NE	
IPMA						
KA6062-DDOT, Infrastructure Project Management Admin	98-1035		2002 Chevrolet S-10 Pickup	Owned	55 M st SE	
KA6062-DDOT, Infrastructure Project Management Admin	98-1993		2003 Chevrolet S-10 Pickup	Owned	55 M st SE	
KA6062-DDOT, Infrastructure Project Management Admin	98-2414		2003 Chevrolet S-10 Pickup	Owned	55 M st SE	
KA6062-DDOT, Infrastructure Project Management Admin	98-3352		2001 Chevrolet Blazer	Owned	55 M st SE	
KA6062-DDOT, Infrastructure Project Management Admin	94-6967		2002 Ford Taurus	Renting from DPW	55 M st SE	
KA6062-DDOT, Infrastructure Project Management Admin	98-8339		2012 Ford F-150	Owned	55 M st SE	
KA6062-DDOT, Infrastructure Project Management Admin	98-8340		2012 Ford F-150	Owned	55 M st SE	
KA6062-DDOT, Infrastructure Project Management Admin	98-9377		2013 Toyota Corolla LE	Leased	55 Mst SE	
KA6062-DDOT, Infrastructure Project Management Admin	98-9686		2013 Dodge Caravan SE	Leased	55 Mst SE	
KA6062-DDOT, Infrastructure Project Management Admin	98-9688		2013 Dodge Caravan SE	Leased	55 Mst SE	
KA6062-DDOT, Infrastructure Project Management Admin	98-9787		2013 Toyota Takoma	Leased	55 M st SE	
KA6062-DDOT, Infrastructure Project Management Admin	98-9788		2013 Toyota Takoma	Leased	55 M st SE	
KA6062-DDOT, Infrastructure Project Management Admin	98-9789		2013 Toyota Takoma	Leased	55 M st SE	
KA6062-DDOT, Infrastructure Project Management Admin	98-9790		2013 Toyota Takoma	Leased	55 M st SE	
KA6062-DDOT, Infrastructure Project Management Admin	98-9791		2013 Toyota Takoma	Leased	55 M st SE	
KA6062-DDOT, Infrastructure Project Management Admin	98-9792		2013 Toyota Takoma	Leased	55 M st SE	
KA6062-DDOT, Infrastructure Project Management Admin	98-9793		2013 Toyota Takoma	Leased	55 M st SE	
KA6062-DDOT, Infrastructure Project Management Admin	98-9794		2013 Toyota Takoma	Leased	55 M st SE	
KA6062-DDOT, Infrastructure Project Management Admin	98-9846		2013 Toyota Takoma	Leased	55 M st SE	
KA6062-DDOT, Infrastructure Project Management Admin	98-9847		2013 Toyota Takoma	Leased	55 M st SE	
KA6062-DDOT, Infrastructure Project Management Admin	98-9849		2013 Toyota Takoma	Leased	55 M st SE	
KA6062-DDOT, Infrastructure Project Management Admin	98-10249		2014 Dodge Grand Caravan	Owned	55 M st SE	
KA6062-DDOT, Infrastructure Project Management Admin	98-10250		2014 Dodge Grand Caravan	Owned	55 M st SE	
IPMA (QA/QC)						
KA6062-DDOT, IPMA QA/QC Division	95-2500		2003 S-10 Pickup	Renting from DPW	400 McMillian Dr NW	
KA6062-DDOT, IPMA QA/QC Division	98-2506		2003 Chevrolet Pickup	Owned	400 McMillian Dr NW	
KA6062-DDOT, IPMA QA/QC Division	98-2507		2003 Chevrolet 2500	Owned	400 McMillian Dr NW	
KA6062-DDOT, IPMA QA/QC Division	98-2580		2001 Chevrolet Pickup	Owned	400 McMillian Dr NW	
KA6062-DDOT, IPMA QA/QC Division	98-4073		2001 Chevrolet Silverado LS	Owned	400 McMillian Dr NW	
KA6062-DDOT, IPMA QA/QC Division	98-4882		2008 Ford Ranger Pickup	Owned	400 McMillian Dr NW	
KA6062-DDOT, IPMA QA/QC Division	98-9850		2013 Toyota Takoma	Leased	400 McMillian Dr NW	
KA6062-DDOT, IPMA QA/QC Division	98-7534		2003 Chevrolet 2500	Owned	400 McMillian Dr NW	
KA6062-DDOT, IPMA QA/QC Division	98-9686		2013 Dodge Caravan	Leased	400 McMillian Dr NW	
SBM						
KA6063-DDOT, Street and Bridge 55 Mst	98-2568		2003 Chevrolet Pickup	Owned	55 M st SE	
KA6063-DDOT, Street and Bridge 55 Mst	98-8293		2012 Chevrolet Volt	Owned	55 Mst SE	
KA6063-DDOT, Street and Bridge 55 Mst	98-8294		2012 Chevrolet Volt	Owned	55 Mst SE	
KA6063-DDOT, Street and Bridge 55 Mst	98-9795		2013 Toyota Takoma	Leased	55 M st SE	
KA6063-DDOT, Street and Bridge 55 Mst	98-9796		2013 Toyota Takoma	Leased	55 M st SE	
KA6063-DDOT, Street and Bridge 55 Mst	98-9845		2013 Toyota Takoma	Leased	55 M st SE	
KA6063-DDOT, Street and Bridge 55 Mst	98-9848		2013 Toyota Takoma	Leased	55 M st SE	
KA6063-DOOT, Street and Bridge 55 Mst	98-10238		2013 Toyota Tacoma	Owned	55 M st SE	
KA6063-DOOT, Street and Bridge 55 Mst	98-10241		2013 Toyota Tacoma	Owned	55 Mst SE	
KA6063-DOOT, Street and Bridge 55 Mst	98-10553		2015 Toyota Tacoma	Owned	56 Mst SE	
SBM						
KA6063-DDOT, Street and Bridge Wst	98-0138		2001 Ford Utility Truck	Owned	1403 Wst NE	

KA6063-DDOT, Street and Bridge Wst	98-0157	2001 Ford Step Van	Owned	1403 Wst NE	
KA6063-DDOT, Street and Bridge Wst	98-0353	1998 GMC TC2000 Street Flusher	Owned	1403 Wst NE	
KA6063-DDOT, Street and Bridge Wst	98-0365	2001 International 4900 6 Wheel Dump	Owned	1403 Wst NE	
KA6063-DDOT, Street and Bridge Wst	98-0377	1986 Mercedes Unimog	Owned	1403 Wst NE	
KA6063-DDOT, Street and Bridge Wst	98-10772	2003 Sterling SC8000	Owned	1403 Wst NE	
KA6063-DDOT, Street and Bridge Wst	98-1281	2003 International 4300SBA 4x2 Utility	Owned	1403 Wst NE	
KA6063-DDOT, Street and Bridge Wst	98-1463	2004 Ford F-550 Welding Truck	Owned	1403 Wst NE	
KA6063-DDOT, Street and Bridge Wst	98-1730	2002 International 7400 Tar Patch 4x4	Owned	1403 Wst NE	
KA6063-DDOT, Street and Bridge Wst	98-1731	2002 International 7400 Tar Patch Truck 4x4	Owned	1403 Wst NE	
KA6063-DDOT, Street and Bridge Wst	98-1732	2002 International 7400 Tar Patch Truck 4x4	Owned	1403 Wst NE	
KA6063-DDOT, Street and Bridge Wst	98-2178	2003 Volvo Flusher Truck	Owned	1403 Wst NE	
KA6063-DDOT, Street and Bridge Wst	98-10414	2014 Ford F-350	Owned	1403 Wst NE	
KA6063-DDOT, Street and Bridge Wst	98-2339	2003 International Sweeper	Owned	1403 Wst NE	
KA6063-DDOT, Street and Bridge Wst	98-2419	2003 Chevrolet S-10 Pickup Truck	Owned	1403 Wst NE	
KA6063-DDOT, Street and Bridge Wst	98-10416	2014 Ford F-350	Owned	1403 Wst NE	
KA6063-DDOT, Street and Bridge Wst	98-2541	2003 Chevrolet 2500	Owned	1403 Wst NE	
KA6063-DDOT, Street and Bridge Wst	98-2572	2003 Chevrolet Pickup	Owned	1403 Wst NE	
KA6063-DDOT, Street and Bridge Wst	98-4096	2006 Volvo Tractor	Owned	1403 Wst NE	
KA6063-DDOT, Street and Bridge Wst	98-4543	2000 Intentional 2654 6x4 10 Wheel Dump	Owned	1403 Wst NE	
KA6063-DDOT, Street and Bridge Wst	98-4861	2001 International 4900 6 Wheel Dump-Crash C	Owned	1403 Wst NE	
KA6063-DDOT, Street and Bridge Wst	98-4870	2008 Ford Ranger Pickup	Owned	1403 Wst NE	
KA6063-DDOT, Street and Bridge Wst	98-4883	2008 Ford F-350	Owned	1403 Wst NE	
KA6063-DDOT, Street and Bridge Wst	98-4888	2008 Ford F-350	Owned	1403 Wst NE	
KA6063-DDOT, Street and Bridge Wst	98-4889	2008 Ford F-350	Owned	55 Mst SE	
KA6063-DDOT, Street and Bridge Wst	98-4902	2008 Ford Ranger Pickup	Owned	1403 Wst NE	
KA6063-DDOT, Street and Bridge Wst	98-4903	2008 Ford F-350	Owned	1403 Wst NE	
KA6063-DDOT, Street and Bridge Wst	98-4904	2008 Ford F-350	Owned	1403 Wst NE	
KA6063-DDOT, Street and Bridge Wst	98-4905	2008 Ford F-350	Owned	1403 Wst NE	
KA6063-DDOT, Street and Bridge Wst	98-4907	2008 International 7400 6 Wheel Dump	Owned	1403 Wst NE	
KA6063-DDOT, Street and Bridge Wst	98-4915	2008 Ford F-350	Owned	1403 Wst NE	
KA6063-DDOT, Street and Bridge Wst	98-4916	2008 Ford F-350	Owned	1403 Wst NE	
KA6063-DDOT, Street and Bridge Wst	98-4946	2008 International 7600SFA 10 Wheel	Owned	1403 Wst NE	
KA6063-DDOT, Street and Bridge Wst	98-6927	2001 International 4900 6 Wheel Dump	Owned	1403 Wst NE	
KA6063-DDOT, Street and Bridge Wst	98-6934	2001 International 4700	Owned	1403 Wst NE	
KA6063-DDOT, Street and Bridge Wst	98-10773	2009 International 7400 6 Wheel Dump	Owned	1403 Wst NE	
KA6063-DDOT, Street and Bridge Wst	98-7078	2008 Ford F-550	Owned	1403 Wst NE	
KA6063-DDOT, Street and Bridge Wst	98-7081	2008 Ford F-550	Owned	1403 Wst NE	
KA6063-DDOT, Street and Bridge Wst	98-7084	2008 Ford F-550	Owned	1403 Wst NE	
KA6063-DDOT, Street and Bridge Wst	98-7104	2008 Ford F-550	Owned	1403 Wst NE	
KA6063-DDOT, Street and Bridge Wst	98-7123	2008 Ford F-550	Owned	1403 Wst NE	
KA6063-DDOT, Street and Bridge Wst	98-7125	2008 Ford F-550	Owned	1403 Wst NE	
KA6063-DDOT, Street and Bridge Wst	98-10774	2008 Ford F-550	Owned	1403 Wst NE	
KA6063-DDOT, Street and Bridge Wst	98-7136	2008 Ford F-550	Owned	1403 Wst NE	
KA6063-DDOT, Street and Bridge Wst	98-7137	2008 Ford F-550	Owned	1403 Wst NE	
KA6063-DDOT, Street and Bridge Wst	98-7267	2001 International 4900 6 Wheel Dump	Owned	1403 Wst NE	
KA6063-DDOT, Street and Bridge Wst	98-7367	2002 International 4900 6 Wheel Dump	Owned	1403 Wst NE	
KA6063-DDOT, Street and Bridge Wst	98-7370	2003 Sterling Stakebody	Owned	1403 Wst NE	
KA6063-DDOT, Street and Bridge Wst	98-7413	2010 Ford F-550	Owned	1403 Wst NE	
KA6063-DDOT, Street and Bridge Wst	98-7414	2010 Ford F-550	Owned	1403 Wst NE	
KA6063-DDOT, Street and Bridge Wst	98-10775	2001 International 4900 6 Wheel Dump	Owned	1403 Wst NE	
KA6063-DDOT, Street and Bridge Wst	98-7594	2003 Sterling SC8000	Owned	1403 Wst NE	
KA6063-DDOT, Street and Bridge Wst	98-7742	2001 Chevrolet 3500	Owned	1403 Wst NE	
KA6063-DDOT, Street and Bridge Wst	98-10765	2001 International 4900 6 Wheel Dump	Owned	1403 Wst NE	
KA6063-DDOT, Street and Bridge Wst	98-7933	2008 International 7600SFA 10 Wheel	Owned	1403 Wst NE	

KA6063-DDOT, Street and Bridge Wst	98-8184	2008 Ford F-550	Owned	1403 Wst NE	
KA6063-DDOT, Street and Bridge Wst	98-8232	2012 Chevrolet Silverado	Owned	1403 Wst NE	
KA6063-DDOT, Street and Bridge Wst	98-8233	2012 Chevrolet Silverado	Owned	1403 Wst NE	
KA6063-DDOT, Street and Bridge Wst	98-8286	2012 Chevrolet F-150	Owned	1403 Wst NE	
KA6063-DDOT, Street and Bridge Wst	98-8298	2012 Freight Liner M2106V 6 Wheel Dump	Owned	1403 Wst NE	
KA6063-DDOT, Street and Bridge Wst	98-8300	2012 Freight Liner M2106V 6 Wheel Dump	Owned	1403 Wst NE	
KA6063-DDOT, Street and Bridge Wst	98-8302	2012 Freight Liner M2106V 6 Wheel Dump	Owned	1403 Wst NE	
KA6063-DDOT, Street and Bridge Wst	98-8327	2012 Freight Liner M2106V 6 Wheel Dump	Owned	1403 Wst NE	
KA6063-DDOT, Street and Bridge Wst	98-8328	2012 Freight Liner M2106V 6 Wheel Dump	Owned	1403 Wst NE	
KA6063-DDOT, Street and Bridge Wst	98-8329	2012 Freight Liner M2106V 6 Wheel Dump	Owned	1403 Wst NE	
KA6063-DDOT, Street and Bridge Wst	98-10769	2002 International 4900 6 Wheel Dump	Owned	1403 Wst NE	
KA6063-DDOT, Street and Bridge Wst	98-10779	2002 International 4900 6 Wheel Dump	Owned	1403 Wst NE	
KA6063-DDOT, Street and Bridge Wst	98-8441	2003 Sterling LT9500	Owned	1403 Wst NE	
KA6063-DDOT, Street and Bridge Wst	98-8442	2008 Ford F-550	Owned	1403 Wst NE	
KA6063-DDOT, Street and Bridge Wst	98-8443	2009 International 7400 6 Wheel Dump	Owned	1403 Wst NE	
KA6063-DDOT, Street and Bridge Wst	98-10776	2010 International 7400 10 Wheel Dump	Owned	1403 Wst NE	
KA6063-DDOT, Street and Bridge Wst	98-10778	2008 International 7600SFA 10 Wheel	Owned	1403 Wst NE	
KA6063-DDOT, Street and Bridge Wst	98-10768	2010 International 7400 10 Wheel Dump	Owned	1403 Wst NE	
KA6063-DDOT, Street and Bridge Wst	98-8658	2012 Freight Liner M2106V 6 Wheel Dump	Owned	1403 Wst NE	
KA6063-DDOT, Street and Bridge Wst	98-9223	2009 International 7400 6 Wheel Dump	Owned	1403 Wst NE	
KA6063-DDOT, Street and Bridge Wst	98-9247	2001 International 4900 6 Wheel Dump	Owned	1403 Wst NE	
KA6063-DDOT, Street and Bridge Wst	98-9550	2001 International 4900 6 Wheel Dump	Owned	1403 Wst NE	
KA6063-DDOT, Street and Bridge Wst	98-9551	2008 Ford F-550	Owned	1403 Wst NE	
KA6063-DDOT, Street and Bridge Wst	98-9553	2002 International 7400 Tac Truck	Owned	1403 Wst NE	
KA6063-DDOT, Street and Bridge Wst	98-9558	2010 Ford F-550	Owned	1403 Wst NE	
KA6063-DDOT, Street and Bridge Wst	98-9559	2008 International 7600SFA 10 Wheel	Owned	1403 Wst NE	
KA6063-DDOT, Street and Bridge Wst	98-10770	2010 International 7400 10 Wheel Dump	Owned	1403 Wst NE	
KA6063-DDOT, Street and Bridge Wst	98-9561	2010 International 7400 10 Wheel Dump	Owned	1403 Wst NE	
KA6063-DDOT, Street and Bridge Wst	98-10767	2010 International 7400 10 Wheel Dump	Owned	1403 Wst NE	
KA6063-DDOT, Street and Bridge Wst	98-9578	2001 International 4900 6 Wheel Dump	Owned	1403 Wst NE	
KA6063-DDOT, Street and Bridge Wst	98-10766	2009 International 7400 6 Wheel Dump	Owned	1403 Wst NE	
KA6063-DDOT, Street and Bridge Wst	98-10777	2010 International 7400 10 Wheel Dump	Owned	1403 Wst NE	
KA6063-DDOT, Street and Bridge Wst	98-10780	2008 Ford F-550	Owned	1403 Wst NE	
KA6063-DDOT, Street and Bridge Wst	98-9614	2010 International 7400 10 Wheel Dump	Owned	1403 Wst NE	
KA6063-DDOT, Street and Bridge Wst	98-9615	2001 International 4900 6 Wheel Dump- Crash	Owned	1403 Wst NE	
KA6063-DDOT, Street and Bridge Wst	98-10128	2002 Sterling SC8000	Owned	1403 Wst NE	
KA6063-DDOT, Street and Bridge Wst	98-10231	2010 International 7400 10 Wheel Dump	Owned	1403 Wst NE	
KA6063-DDOT, Street and Bridge Wst	98-10413	2014 Ford F-350	Owned	1403 Wst NE	
SBM					
KA6063-DDOT, Street and Bridge Farragut St	98-0134	2001 Ford Utility Truck	Owned	414 Farragut St NE	
KA6063-DDOT, Street and Bridge Farragut St	98-2420	2003 Chevrolet S-10 Pickup Truck	Owned	414 Farragut St NE	
KA6063-DDOT, Street and Bridge Farragut St	98-2816	2000 International 4700	Owned	414 Farragut St NE	
KA6063-DDOT, Street and Bridge Farragut St	98-10568	1998 GMC C8500 6 Wheel Dump	Owned	414 Farragut St NE	
KA6063-DDOT, Street and Bridge Farragut St	98-2820	1998 GMC C8000 6 Wheel Dump	Owned	414 Farragut St NE	
KA6063-DDOT, Street and Bridge Farragut St	98-3992	1997 International 2554 4x2 6 Wheel Dump	Owned	414 Farragut St NE	
KA6063-DDOT, Street and Bridge Farragut St	98-4906	2008 Ford F-350	Owned	414 Farragut St NE	
KA6063-DDOT, Street and Bridge Farragut St	98-4908	2008 International 7400 6 Wheel Dump	Owned	414 Farragut St NE	
KA6063-DDOT, Street and Bridge Farragut St	98-4909	2008 International 7400 6 Wheel Dump	Owned	414 Farragut St NE	
KA6063-DDOT, Street and Bridge Farragut St	98-4910	2008 International 7400 6 Wheel Dump	Owned	414 Farragut St NE	
KA6063-DDOT, Street and Bridge Farragut St	98-5685	2008 Ford F-550	Owned	414 Farragut St NE	
KA6063-DDOT, Street and Bridge Farragut St	98-6929	2001 Freight Liner Step Van	Owned	414 Farragut St NE	
KA6063-DDOT, Street and Bridge Farragut St	98-6930	2001 International 4900 6 Wheel Dump	Owned	414 Farragut St NE	
KA6063-DDOT, Street and Bridge Farragut St	98-10782	2008 Ford F-550	Owned	414 Farragut St NE	
KA6063-DDOT, Street and Bridge Farragut St	98-7079	2008 Ford F-550	Owned	414 Farragut St NE	

KA6063-DDOT, Street and Bridge Farragut St	98-7124	2008 Ford F-550	Owned	414 Farragut St NE	
KA6063-DDOT, Street and Bridge Farragut St	98-7126	2008 Ford F-550	Owned	414 Farragut St NE	
KA6063-DDOT, Street and Bridge Farragut St	98-7141	2008 Ford F-350	Owned	414 Farragut St NE	
KA6063-DDOT, Street and Bridge Farragut St	98-7368	2002 International 4900 6 Wheel Dump	Owned	414 Farragut St NE	
KA6063-DDOT, Street and Bridge Farragut St	98-7394	2009 Ford F-550	Owned	414 Farragut St NE	
KA6063-DDOT, Street and Bridge Farragut St	98-7415	2010 Ford F-550	Owned	414 Farragut St NE	
KA6063-DDOT, Street and Bridge Farragut St	98-7625	2002 International 4900 6 Wheel Dump	Owned	414 Farragut St NE	
KA6063-DDOT, Street and Bridge Farragut St	98-7723	2008 Ford F-550	Owned	414 Farragut St NE	
KA6063-DDOT, Street and Bridge Farragut St	98-7929	2008 Ford F-550	Owned	414 Farragut St NE	
KA6063-DDOT, Street and Bridge Farragut St	98-8301	2012 Freight Liner M2106V 6 Wheel Dump	Owned	414 Farragut St NE	
KA6063-DDOT, Street and Bridge Farragut St	98-8303	2012 Freight Liner M2106V 6 Wheel Dump	Owned	414 Farragut St NE	
KA6063-DDOT, Street and Bridge Farragut St	98-8304	2012 Freight Liner M2106V 6 Wheel Dump	Owned	414 Farragut St NE	
KA6063-DDOT, Street and Bridge Farragut St	98-8323	2012 Ford F-150	Owned	414 Farragut St NE	
KA6063-DDOT, Street and Bridge Farragut St	98-8385	2008 Ford F-550	Owned	414 Farragut St NE	
KA6063-DDOT, Street and Bridge Farragut St	98-8386	2009 International 7400 6 Wheel Dump	Owned	441 Farragut St NE	
KA6063-DDOT, Street and Bridge Farragut St	98-8395	2002 International 4900 6 Wheel Dump	Owned	414 Farragut St NE	
KA6063-DDOT, Street and Bridge Farragut St	98-8402	1998 GMC C8000	Owned	414 Farragut St NE	
KA6063-DDOT, Street and Bridge Farragut St	98-8439	2009 International 7400 6 Wheel Dump	Owned	414 Farragut St NE	
KA6063-DDOT, Street and Bridge Farragut St	98-8512	2001 International 4900 6 Wheel Dump	Owned	414 Farragut St NE	
KA6063-DDOT, Street and Bridge Farragut St	98-8661	2012 Freight Liner M2106V 6 Wheel Dump	Owned	414 Farragut St NE	
KA6063-DDOT, Street and Bridge Farragut St	98-8657	2012 Freight Liner M2106V 6 Wheel Dump	Owned	414 Farragut St NE	
KA6063-DDOT, Street and Bridge Farragut St	98-8659	2012 Freight Liner M2106V 6 Wheel Dump	Owned	414 Farragut St NE	
KA6063-DDOT, Street and Bridge Farragut St	98-8660	2012 Freight Liner M2106V 6 Wheel Dump	Owned	414 Farragut St NE	
KA6063-DDOT, Street and Bridge Farragut St	98-8677	2012 Freight Liner M2106V 6 Wheel Dump	Owned	414 Farragut St NE	
KA6063-DDOT, Street and Bridge Farragut St	98-10771	2009 International 7400 6 Wheel Dump	Owned	414 Farragut St NE	
KA6063-DDOT, Street and Bridge Farragut St	98-9167	2009 International 7400 6 Wheel Dump	Owned	414 Farragut St NE	
KA6063-DDOT, Street and Bridge Farragut St	98-10781	2009 International 7400 6 Wheel Dump	Owned	414 Farragut St NE	
KA6063-DDOT, Street and Bridge Farragut St	98-9198	2009 International 7400 6 Wheel Dump	Owned	414 Farragut St NE	
KA6063-DDOT, Street and Bridge Farragut St	98-9552	2001 International 4900 6 Wheel Dump	Owned	414 Farragut St NE	
KA6063-DDOT, Street and Bridge Farragut St	98-9577	2001 International 4900	Owned	414 Farragut St NE	
KA6063-DDOT, Street and Bridge Farragut St	98-9579	2002 International 4900 6 Wheel	Owned	414 Farragut St NE	
KA6063-DDOT, Street and Bridge Farragut St	98-9584	2008 Ford F-550	Owned	414 Farragut St NE	
KA6063-DDOT, Street and Bridge Farragut St	98-9585	2008 Ford F-550	Owned	414 Farragut St NE	
KA6063-DDOT, Street and Bridge Farragut St	98-9669	2013 Peterbilt Flusher Truck	Owned	414 Farragut St NE	
TOA (Signal Maintenance)					
KA6064-DDOT, Information Technology System Support Div	98-0135	2001 Ford F-250	Owned	1338 Rear G st SE	
KA6064-DDOT, Information Technology System Support Div	98-0137	2001 Ford F-250	Owned	1338 Rear G st SE	
KA6064-DDOT, Information Technology System Support Div	98-2415	2003 Chevrolet S-10 Pickup	Owned	1338 Rear G st SE	
KA6064-DDOT, Information Technology System Support Div	98-2421	2003 Chevrolet S-10 Pickup	Owned	1338 Rear G st SE	
KA6064-DDOT, Information Technology System Support Div	98-3359	1999 Ford Econoline	Owned	1338 Rear G st SE	
KA6064-DDOT, Information Technology System Support Div	98-4288	2005 Ford Bucket Truck	Owned	1338 Rear G st SE	
KA6064-DDOT, Information Technology System Support Div	98-4289	2005 Ford Bucket Truck	Owned	1338 Rear G st SE	
KA6064-DDOT, Information Technology System Support Div	98-4328	2000 Ford Bucket Truck	Owned	1338 Rear G st SE	
KA6064-DDOT, Information Technology System Support Div	98-7903	2010 Ford E-350	Owned	1338 Rear G st SE	
KA6064-DDOT, Information Technology System Support Div	98-7904	2010 Ford E-350	Owned	1338 Rear G st SE	
KA6064-DDOT, Information Technology System Support Div	98-9365	2012 Chevrolet Silverado	Leased	1338 Rear G st SE	
KA6064-DDOT, Information Technology System Support Div	98-10242	2013 Toyota Tacoma	Owned	1338 Rear G st SE	
KA6064-DDOT, Information Technology System Support Div	98-10244	2013 Toyota Tacoma	Owned	1338 Rear G st SE	
TOA (Traffic Engineering)					
KA6064-DDOT, ITS & Traffic Signs Safety Standards	98-2733	2002 Chevrolet Blazer	Owned	55 Mst SE	
KA6064-DDOT, ITS & Traffic Signs Safety Standards	98-8324	2012 Ford F-150 Pickup	Owned	55 Mst SE	
KA6064-DDOT, ITS & Traffic Signs Safety Standards	98-8342	2012 Ford F-150 4x4	Owned	55 Mst SE	
KA6064-DDOT, ITS & Traffic Signs Safety Standards	98-10370	2014 Dodge Grand Caravan	Owned	55 Mst SE	
TOA (ITS Device Maintenance)					

KA6064-DDOT,Information Technology System Support Div	98-0975		2001 Ford Expedition	Owned	2000 14th st (Reeves ctr)	
KA6064-DDOT,Information Technology System Support Div	98-1018		2002 Ford Van	Owned	1735 15th Street NE	
KA6064-DDOT,Information Technology System Support Div	98-4287		2005 Ford Bucket Truck	Owned	1735 15th Street NE	
KA6064-DDOT,Information Technology System Support Div	98-4552		2002 Chevrolet 1500 Pickup	Owned	1735 15th Street NE	
KA6064-DDOT,Information Technology System Support Div	98-4553		2001 Ford F-450 Lift	Owned	1735 15th Street NE	
KA6064-DDOT,Information Technology System Support Div	98-4554		2003 Chevrolet Express Van	Owned	1735 15th Street NE	
KA6064-DDOT,Information Technology System Support Div	98-4555		2003 Chevrolet Express Van	Owned	1735 15th Street NE	
KA6064-DDOT, Information Technology System Support Div	98-4556		2003 Ford F-550 Bucket Truck	Owned	1735 15th Street NE	
KA6064-DDOT, Information Technology System Support Div	98-8282		2012 Ford F-150	Owned	1735 15th Street NE	
KA6064-DDOT,Information Technology System Support Div	98-8341		2012 Ford F-150 4x4	Owned	2000 14th st (Reeves ctr)	
KA6064-DDOT,Information Technology System Support Div	98-9610		2013 Chevrolet Express Van	Owned	1735 15th Street NE	
KA6064-DDOT,Information Technology System Support Div	98-9611		2013 Chevrolet Express Van	Owned	1735 15th Street NE	
KA6064-DDOT, Information Technology System Support Div	98-10243		2013 Toyota Tacoma	Owned	2000 14th st (Reeves ctr)	
TOA (SCG)						
KA6065-DDOT, School Crossing Guards Div	98-10251		2014 Dodge Grand Caravan	Owned	2000 14th st (Reeves ctr)	
KA6065-DDOT, School Crossing Guards Div	98-2812		2001 Ford Focus	Owned	2000 14th st (Reeves ctr)	
KA6065-DDOT, School Crossing Guards Div	98-4868		2008 Ford Ranger Pickup	Owned	2000 14th st (Reeves ctr)	
KA6065-DDOT, School Crossing Guards Div	98-4873		2008 Ford Ranger Pickup	Owned	2000 14th st (Reeves ctr)	
KA6065-DDOT, School Crossing Guards Div	98-4884		2008 Ford Ranger Pickup	Owned	2000 14th st (Reeves ctr)	
KA6065-DDOT, School Crossing Guards Div	98-10155		2013 Toyota Corolla LE	Owned	2000 14th st (Reeves ctr)	
KA6065-DDOT, School Crossing Guards Div	98-10156		2013 Toyota Corolla LE	Owned	2000 14th st (Reeves ctr)	
TOA (City-wide Streetlights/Parking)						
KA6068-DDOT, Citywide Div	98-2732		2001 Ford Truck	Owned	55 Mst SE	
KA6068-DDOT, Citywide Div	98-4887		2008 Ford Ranger Pickup	Owned	55 Mst SE	
KA6068-DDOT, Citywide Div	98-7870		2011 Chevrolet Silverado	Owned	55 Mst SE	
KA6068-DDOT, Citywide Div	98-8295		2012 Ford F-150	Owned	55 Mst SE	
KA6068-DDOT, Citywide Div	98-8296		2012 Ford F-150	Owned	55 Mst SE	
KA6068-DDOT, Citywide Div	98-8297		2012 Ford F-150	Owned	55 Mst SE	
KA6068-DDOT, Citywide Div	98-8338		2012 Ford F-150 4x4	Owned	55 Mst SE	
KA6068-DDOT, Citywide Div	98-8531		2014 Toyota Tacoma	Owned	55 Mst SE	
KA6068-DDOT, Citywide Div	98-10696		2015 Toyota Tacoma	Owned	55 Mst SE	
KA6068-DDOT, Citywide Div	98-10711		2015 Toyota Tacoma	Owned	56 Mst SE	
UFA						
KA6069-DDOT, Urban Forestry Administration	98-8061		2014 Toyota Tacoma	Owned	55 Mst SE	
KA6069-DDOT, Urban Forestry Administration	98-8062		2014 Toyota Tacoma	Owned	55 Mst SE	
KA6069-DDOT, Urban Forestry Administration	98-8060		2014 Toyota Tacoma	Owned	55 Mst SE	
KA6069-DDOT, Urban Forestry Administration	98-4869		2007 Ford Ranger Pickup	Owned	55 Mst SE	
KA6069-DDOT, Urban Forestry Administration	98-6349		2008 Ford Ranger Pickup	Owned	55 Mst SE	
KA6069-DDOT, Urban Forestry Administration	95-6628		2009 Honda Civic Hybrid	Renting from DPW	55 Mst SE	
KA6069-DDOT, Urban Forestry Administration	98-8283		2012 Ford F-150	Owned	55 Mst SE	
KA6069-DDOT, Urban Forestry Administration	98-8284		2012 Ford F-150	Owned	55 Mst SE	
KA6069-DDOT, Urban Forestry Administration	98-8285		2012 Ford F-150	Owned	55 Mst SE	
KA6069-DDOT, Urban Forestry Administration	98-8346		2012 Ford F-150	Owned	55 Mst SE	
KA6069-DDOT, Urban Forestry Administration	98-8656		2012 Ford F-150	Owned	55 Mst SE	
KA6069-DDOT, Urban Forestry Administration	98-9367		2013 Toyota Corolla LE	Leased	55 Mst SE	
KA6069-DDOT, Urban Forestry Administration	98-9378		2013 Toyota Corolla LE	Leased	55 Mst SE	
KA6069-DDOT, Urban Forestry Administration	98-10157		2013 Toyota Corolla LE	Owned	55 Mst SE	
UFA						
KA6069-DDOT, Urban Forestry Administration	98-0869		2002 Sterling M7500	Owned	1403 Wst NE	
KA6069-DDOT, Urban Forestry Administration	98-0912		2002 Chevrolet Bucket Truck	Owned	1403 Wst NE	
KA6069-DDOT, Urban Forestry Administration	98-0987		2002 GMC T8500	Owned	1403 Wst NE	
KA6069-DDOT, Urban Forestry Administration	98-1068		2002 International Bucket Truck	Owned	1403 Wst NE	
KA6069-DDOT, Urban Forestry Administration	98-2847		2002 GMC T8500	Owned	1403 Wst NE	
KA6069-DDOT, Urban Forestry Administration	98-3356		2001 GMC T8500	Owned	1403 Wst NE	

KA6069-DDOT, Urban Forestry Administration	98-3823	2005 Sterling LT9500	Owned	1403 Wst NE	
KA6069-DDOT, Urban Forestry Administration	98-9355	2012 Chevrolet Silverado	Leased	1403 Wst NE	
KA6069-DDOT, Urban Forestry Administration	98-7242	2008 Sterling Bucket Truck	Owned	1403 Wst NE	
KA6069-DDOT, Urban Forestry Administration	94-7741	2008 Ford F-150	Renting from DPW	1403 Wst NE	
KA6069-DDOT, Urban Forestry Administration	98-7810	2009 Ultimate Diesel Hawk H1150	Owned	1403 Wst NE	
KA6069-DDOT, Urban Forestry Administration	98-7814	2009 Ultimate Diesel Hawk H1150	Owned	1403 Wst NE	
KA6069-DDOT, Urban Forestry Administration	98-7819	1999 GMC T8500	Owned	1403 Wst NE	
KA6069-DDOT, Urban Forestry Administration	98-8369	2011 Ford F-350	Owned	1403 Wst NE	
PTSA					
KA6071-DDOT, Progressive Transportation Services Admin	98-10158	2013 Toyota Corolla LE	Owned	55 Mst SE	
KA6071-DDOT, Progressive Transportation Services Admin	98-10194	2014 Chevrolet Silverado 1500	Owned	55 Mst SE	

Note:

Total: 387 Vehicle include:

15 Segways

28 Leased

6 Rentals from DPW

Strauss	Steve	Deputy Associate Director	PTSA	AASHTO SCORT Meeting	For Worth, TX	AASHTO	9/9/2015	9/11/2015	\$ 1,378.20
Broskoff	Diar	Supervisory Civil Engineer	IPMA	2015 AASHTO Technical Committee Meeting	Portland, ME	ME DOT	9/15/2015	9/16/2015	\$ 961.84
Harvey	Amanda	Program Analyst	OD	Dresnence 2015 Conference	San Francisco, CA	Saladence	09/15/15	09/18/15	\$ 3,740.00
Richards	Laura	Transportation Mgmt Specialist	PPSA	Improving Freight Systems	New York, NY	Rensseler Polytechnic Institute	9/16/2015	9/16/2015	\$ 458.00
Kim	Huntae	Supervisory Civil Engineer	IPMA	Earth-Retaining Structures	Las Vegas, NV	American Society of Engineers	9/20/2015	9/23/2015	\$ 2,402.55
Gillis	Greer	Deputy Director	OD	2015 AASHTO Conference	Chicago, IL	AASHTO	09/24/15	09/27/15	\$ 2,404.64
Dastgheib	Fabihah	Transportation Planner	PPSA	National Shared Mobility Summit	Chicago, IL	Shared Use Mobility Center	9/28/2015	9/29/2015	\$ 575.00
Lucas	Kimberly	Bicycle Program Specialist	PPSA	National Shared Mobility Summit	Chicago, IL	Shared Use Mobility Center	9/28/2015	9/29/2015	\$ 1,392.20
Rogers	Jonathan	Transportation Planner	PPSA	Association of Pedestrian and Bicycle Professionals	Saint Louis, MO	Association of Pedestrian and Bicycle Professionals	9/29/2015	10/1/2015	\$ 1,578.26
Bailey Thomas	Nana	Assistant Attorney General	OD	Collective Bargaining Course: Fundamental Negotiating Skills	New York, NY	Cornell University	09/30/15	10/02/15	\$ 2,257.16
Abel	Iama	Supervisory General Engineer	TOA	IES and Area Lighting Conference	Savannah, GA	IES	10/4/2015	10/7/2015	\$ 2,372.01
Crane	Margaret	Assistant General Counsel	OGC	Design Build Institute of America Owner Boot Camp	Charlotte, NC	Design Build Institute of America	10/4/2015	10/7/2015	\$ 2,428.95
Nguyen	Tan	Electrical Engineer Technician	TOA	IES and Area Lighting Conference	Savannah, GA	IES	10/4/2015	10/7/2015	\$ 2,562.55
Gillis	Greer	Deputy Director	OD	CMAA National Conference	Orlando, FL	CMAA	10/11/2015	10/12/2015	\$ 1,768.96
Hoffman	Paul	Deputy Chief Engineer	IPMA	Ohio Transportation Technology Conference	Columbus, OH	Ohio Department of Transportation	10/26/2015	10/28/2015	\$ 735.86
Graham	James	GIS & Applications Manager	OD	HiDaC 2015 National Conference	Austin, TX	Texas Department of Transportation	11/4/2015	11/6/2015	\$ 650.37
Upchurch	Meredith	Landscape Architect	IPMA	American Society of Landscape Architects Annual Meeting	Chicago, IL	American Society of Landscape Architects	11/6/2015	11/9/2015	\$ 1,590.24
Freeman	Stanley	Civil Engineer	IPMA	SSPC Level 2 Prepping and Painting Bridges	Petersburg, FL	The Society for the Protective Coatings	11/16/2015	11/21/2015	\$ 2,751.52
Dorritz	Zahra	Supervisory Civil Engineer	IPMA	National Accelerated Bridge Construction	Miami, FL	National Accelerated Bridge Construction Conference	12/6/2015	12/8/2015	\$ 1,798.17
Siraga	Bruke	Civil Engineer	IPMA	ITS World Conference	Miami, FL	ITS	12/6/2015	12/9/2015	\$ 342.00
Kim	Huntae	Supervisory Civil Engineer	IPMA	Accelerated Bridge Construction	Miami, FL	Florida International University	12/7/2015	12/8/2015	\$ 1,038.02
Walker	Charnia	Management Liaison Specialist	OD	Effective Employee Relations	New York	Cornell University	12/7/2015	12/10/2015	\$ 6,083.17
Sarabi	Aidin	Civil Engineer	IPMA	Improving the seismic of existing structures	San Francisco, CA	American Society of Civil Engineers (ASCE)	12/9/2015	12/14/2015	\$ 1,170.24
Eskender	Konjit	Civil Engineer	IPMA	Safety Inspection of In- Service	Newark, Delaware	FHWA- NHI	1/25/2016	2/5/2016	\$ 4,646.00
Torruellas	Grace	Program Analyst	PTSA	Orientation to Transit	San Bernardino, CA	The National Transit Institute	1/26/2016	1/29/2016	\$ 909.96
Govvyr	Ravindra	Deputy Associate Director	IPMA	Mid Atlantic Quality Assurance Workshop	Cambridge, MD	Mid Atlantic QAW	2/9/2016	2/11/2016	\$ 940.04
Griffin	Jason	Civil Engineer	IPMA	QAW Mid-Atlantic Quality Assurance	Cambridge, MD	Mid Atlantic QAW	2/9/2016	2/11/2016	\$ 192.00
Ledda	Patrick	Civil Engineer	IPMA	QAW Mid-Atlantic Quality Assurance	Cambridge, MD	Mid Atlantic QAW	2/9/2016	2/11/2016	\$ 192.00
Manga	Eto-Manyi	Civil Engineer	IPMA	QAW Mid-Atlantic Quality Assurance	Cambridge, MD	Mid Atlantic QAW	2/9/2016	2/11/2016	\$ 192.00
Nahh	Daniel	Civil Engineer	IPMA	QAW Mid-Atlantic Quality Assurance	Cambridge, MD	Mid Atlantic QAW	2/9/2016	2/11/2016	\$ 192.00
Seals	Frank	General Counsel	OD	Commercial Law Section: Connecting People, Ideas and Opportunities	Scottsdale, AZ	National Bar Association	2/17/2016	2/21/2016	\$ 1,639.00
Alston	Charlotte	Training Specialist	OD	11th Annual FTA Drug & Alcohol	Sacramento, CA	Federal Transit Administration	3/21/2016	3/25/2016	\$ 1,477.60
Ieragin	Michael	Construction Rep. Maint. Officer	PSRA	2016 National Hurricane Conference	Orlando, FL	National Hurricane Conference	3/21/2016	3/24/2016	\$ 1,869.98
Pettus	Angela	Program Analyst	OD	11th Annual FTA Drug & Alcohol	Sacramento, CA	Federal Transit Administration	3/21/2016	3/25/2016	\$ 1,477.60
Pettus	Angela	Program Analyst	TOA	11th Annual FTA Drug & Alcohol Conference	Sacramento, CA	Federal Transit Administration	3/21/2016	3/26/2016	\$ 1,477.60
Wimzor	Malika	Program Analyst	OD	FTA National Conference	Sacramento, CA	Federal Transit Administration	3/21/2016	3/26/2016	\$ 1,607.78
Patterson	Sharon	Program Analyst	OD	2016 Talent Management Conference & Exposition	Orlando, FL	Society for Human Resources Management	4/16/2016	4/20/2016	\$ 4,938.55

Total \$ 322,522.86

Breakdown of FY15 DDOT Employee Overtime Charges

Contracting & Procurement - Contract Administration				
Name	Index	TITLE	Type	Total Hours
WATSON,NEAL A	L5952	OAID/SNOW	Operating	68
Contracting & Procurement - Contracting & Procurement				
Name	Index	TITLE	Type	Total Hours
DALEY,NEVILLE	L5952	OAID/SNOW	Operating	18
Contracting & Procurement - Contracts				
Name	Index	TITLE	Type	Total Hours
BENSON,KIRK M	L5952	OAID/SNOW	Operating	3
Employees not in current Schedule A - Employees not in current Schedule A				
Name	Index	TITLE	Type	Total Hours
DONALDSON,DAVID	L5684	POPE FRANCIS VISIT 2015	Operating	2
	L5952	OAID/SNOW	Operating	88
	L5674	Marion Barry's Celebration	Operating	2
	L5673	Concert for Valor	Operating	12
	L5402	TOTM/TRAFFIC CONTROL OPERATIONS	Operating	68
HILL,GEORGE V	L5677	FY15 Baseball	Operating	6
	L5401	TOTM/SCHOOL CROSSING GUARD	Operating	9
PERRY,DERRICK D	L7100	DEPARTMENT OF TRANSPORTATION	Operating	301
	L5POT	Pothole and Pavement Campaign	Operating	48
IPMA - Anacostia Waterfront Initiativ				
Name	Index	TITLE	Type	Total Hours
ARNO,REGINALD	K0205	PREVENT FLOOD IN BLOOMINGDALE	Direct	8

CLOYD,RA'ADIA K

T4561	8888(286)prg. mngt-awi	Direct	55
L5POT	Pothole and Pavement Campaign	Operating	10
L5952	OAID/SNOW	Operating	43

D'ARBELA,DENIS

T3939	Rehab 16th St over Military	Direct	122
K0311	i-395 HOV BR OOV POTOMAC RIVER	Direct	8
L5952	OAID/SNOW	Operating	29

DORSEY,JOSEPH D

T4613	NH-1501(37)SCap St EIS	Direct	16
T4561	8888(286)prg. mngt-awi	Direct	147
L5952	OAID/SNOW	Operating	146
L5POT	Pothole and Pavement Campaign	Operating	15

FIELDS,LACRECIA

T4561	8888(286)prg. mngt-awi	Direct	15
22770	DEPARTMENT OF TRANSPORTATION	Indirect	21

OKECHUKWU,ALEX

T3939	Rehab 16th St over Military	Direct	5
T3221	SUITLD PKWY-MLK AVE IMPRVS NH-1304(10)	Direct	66
T3941	Rehab 16th st over Military	Direct	14
L5952	OAID/SNOW	Operating	2

OLADOKUN,ABIODU

K0520	RALLY FOR ALLYS (ALLY PALOOZA)	Direct	52
T3910	FY08 CAPITAL PROJ PROFILE ESTABLISHMENT	Direct	0
T4561	8888(286)prg. mngt-awi	Direct	10
22770	DEPARTMENT OF TRANSPORTATION	Indirect	11
L5952	OAID/SNOW	Operating	59

SIMIE,EJIGINEH

T4561	8888(286)prg. mngt-awi	Direct	30
T2904	FY03 LOCAL RECONST/RESURF/UPGRD WARD 6	Direct	3
T4066	Kenilworth Riverwalk Trail	Direct	4
L2002	PROJECT DEVELOPMENT AND MANAGEMENT	Operating	11

IPMA - Asset Management

Name	Index	TITLE	Type	Total Hours
AZZAM,AMAL E	L5952	OAID/SNOW	Operating	65

IPMA - Asset Management Analysis Divi

Name	Index	TITLE	Type	Total Hours
CARPENTER,EDWAR				
	T4658	STP-8888(374)FY11 FA PR	Direct	17
	K0462	Data Collection, Anal & Dissem	Direct	9
	L5952	OAID/SNOW	Operating	3
HORTON JR,ROBERT				
	T2816	FY03 NEW/REPAIR CURB/SDWLK/ALLEY WD 3&4	Direct	43
	T4658	STP-8888(374)FY11 FA PR	Direct	97
	L5952	OAID/SNOW	Operating	26
MAKONNEN,WOLDE				
	T2880	FY03 LOCAL RECONST/RESURF/UPGRD WARD 2E	Direct	7
	K0520	RALLY FOR ALLYS (ALLY PALOOZA)	Direct	4
	K0064	Asset Inventory/ADA compliance	Direct	20
	T2888	Local Restr, resurf, upgr- W5	Direct	6
	T4658	STP-8888(374)FY11 FA PR	Direct	21
	22770	DEPARTMENT OF TRANSPORTATION	Indirect	8
MATHARU,JASWAN				
	T4956	FY12 Guiderail and Attenuators	Direct	6
	K0062	FA13 FA Pavement Restoration, NHS	Direct	293
	T4513	FY10 Constultant Bridge Insp	Direct	6
	T2816	FY03 NEW/REPAIR CURB/SDWLK/ALLEY WD 3&4	Direct	12
	CA521	RMAS-Roadway Maint Section	Indirect	9
	22770	DEPARTMENT OF TRANSPORTATION	Indirect	2
	L5POT	Pothole and Pavement Campaign	Operating	51
	L5952	OAID/SNOW	Operating	50
MOON,ADRIAN S				
	T3910	FY08 CAPITAL PROJ PROFILE ESTABLISHMENT	Direct	34
	K0520	RALLY FOR ALLYS (ALLY PALOOZA)	Direct	82
	T3909	FY08 CAPITAL PROJ PROFILE ESTABLISHMENT	Direct	64
	T2816	FY03 NEW/REPAIR CURB/SDWLK/ALLEY WD 3&4	Direct	220
	22770	DEPARTMENT OF TRANSPORTATION	Indirect	37
	L5POT	Pothole and Pavement Campaign	Operating	8
	L5952	OAID/SNOW	Operating	82

RENNIE,SIMON A

T4511	Conslt Br FY12-16Asst Prs STP	Direct	12
L5952	OAID/SNOW	Operating	147

TOYER,DELANTE T

T3910	FY08 CAPITAL PROJ PROFILE ESTABLISHMENT	Direct	18
T4658	STP-8888(374)FY11 FA PR	Direct	162
T2816	FY03 NEW/REPAIR CURB/SDWLK/ALLEY WD 3&4	Direct	280
K0520	RALLY FOR ALLYS (ALLY PALOOZA)	Direct	151
T2888	Local Restr, resurf, upgr- W5	Direct	36
L5952	OAID/SNOW	Operating	8

IPMA - Bridge and Tunnel Branch

Name	Index	TITLE	Type	Total Hours
-------------	--------------	--------------	-------------	--------------------

COLE,HERMAN E

T4155	Preventitive Maintenance / Emergency Repairs	Direct	8
L5952	OAID/SNOW	Operating	4

IPMA - Field Operations/Research Sect

Name	Index	TITLE	Type	Total Hours
-------------	--------------	--------------	-------------	--------------------

LADIPOH,ALBERT

T3941	Rehab 16th st over Military	Direct	19
L5952	OAID/SNOW	Operating	64

MANGA,ETA-MANYI

MTL13	Material Testing	Indirect-MTEST	2
-------	------------------	----------------	---

PATEL,BIPINBHAI R

T2880	FY03 LOCAL RECONST/RESURF/UPGRD WARD 2E	Direct	2
K0062	FA13 FA Pavement Restoration, NHS	Direct	21
T2816	FY03 NEW/REPAIR CURB/SDWLK/ALLEY WD 3&4	Direct	13
T3941	Rehab 16th st over Military	Direct	79
T4263	Intra District - MOU	Direct	8
T4658	STP-8888(374)FY11 FA PR	Direct	24
22770	DEPARTMENT OF TRANSPORTATION	Indirect	8
MTL13	Material Testing	Indirect-MTEST	34

WALLER,KENNETH

T4845	RI Ave Ped/Bike Br	Direct	4
T2816	FY03 NEW/REPAIR CURB/SDWLK/ALLEY WD 3&4	Direct	8
L5952	OAID/SNOW	Operating	32

IPMA - IPMA

Name	Index	TITLE	Type	Total Hours
BEMBRY,JESSICA I				
	22770	DEPARTMENT OF TRANSPORTATION	Indirect	55
	L5952	OAID/SNOW	Operating	7
BROGDEN,TROY				
	T4561	8888(286)prg. mngt-awi	Direct	1
	T4391	Rehab NH Ave,NW VA Ave-Dupont	Direct	1
	L5POT	Pothole and Pavement Campaign	Operating	29
	L5952	OAID/SNOW	Operating	79
	L2002	PROJECT DEVELOPMENT AND MANAGEMENT	Operating	2
CONLEY,YVETTE E				
	22770	DEPARTMENT OF TRANSPORTATION	Indirect	6
FRANKS,CARMEN				
	T4263	Intra District - MOU	Direct	2
HABTEMARIAM,AKL				
	T2904	FY03 LOCAL RECONST/RESURF/UPGRD WARD 6	Direct	42
	L5952	OAID/SNOW	Operating	30
PAUL,ALBERTA L				
	L5952	OAID/SNOW	Operating	9
	L2002	PROJECT DEVELOPMENT AND MANAGEMENT	Operating	183
ROBINSON,ELIJAH				
	T4155	Preventitive Maintenance / Emergency Repairs	Direct	4
	K0062	FA13 FA Pavement Restoration, NHS	Direct	56
	K0470	Capital Crossing Development	Direct	4
	T4658	STP-8888(374)FY11 FA PR	Direct	33
	T4667	CW TRANSP MGMT PLAN	Direct	17
	L5952	OAID/SNOW	Operating	98
UDEH,MADUABUCH				
	T4658	STP-8888(374)FY11 FA PR	Direct	16
	T2880	FY03 LOCAL RECONST/RESURF/UPGRD WARD 2E	Direct	4
	K0520	RALLY FOR ALLYS (ALLY PALOOZA)	Direct	51
WILLIAMS II,ERROL				
	T4085	StreetCars	Direct	5
	22770	DEPARTMENT OF TRANSPORTATION	Indirect	4

IPMA - Local Roadway Projects

Name	Index	TITLE	Type	Total Hours
JAMABO,DEINMA A				
	K0348	GA Ave,NW Dedicated Bus Lane	Direct	166
	T4391	Rehab NH Ave,NW VA Ave-Dupont	Direct	4
	T3939	Rehab 16th St over Military	Direct	91
	T4966	C&O Canal Wall Capstone Rplmnt	Direct	138
	T4658	STP-8888(374)FY11 FA PR	Direct	33
	L5952	OAID/SNOW	Operating	14
MIRCHANDANI, RAM				
	22770	DEPARTMENT OF TRANSPORTATION	Indirect	104
OLAORE, OLUSEGUN				
	K0348	GA Ave,NW Dedicated Bus Lane	Direct	3
	K0480	15th St,NW Safety Improvements	Direct	2
	22770	DEPARTMENT OF TRANSPORTATION	Indirect	2

IPMA - Materials Laboratory

Name	Index	TITLE	Type	Total Hours
SCHNEIDER, MICHAEL				
	K0123	CT AVE Stscape Pase III	Direct	4
	T4658	STP-8888(374)FY11 FA PR	Direct	12

IPMA - Safety Standards and Quality C

Name	Index	TITLE	Type	Total Hours
KEST, DANIEL J				
	T3941	Rehab 16th st over Military	Direct	4
	T4561	8888(286)prg. mngt-awi	Direct	8
	K0123	CT AVE Stscape Pase III	Direct	4
	T4658	STP-8888(374)FY11 FA PR	Direct	36
	22770	DEPARTMENT OF TRANSPORTATION	Indirect	16
	MTL13	Material Testing	Indirect-MTEST	12
	L5952	OAID/SNOW	Operating	26

KRETSI,CHARLES K

K0213	REHAB OF 1ST ST NE	Direct	8
K0123	CT AVE Stscape Pase III	Direct	16
K0062	FA13 FA Pavement Restoration, NHS	Direct	4
K0226	Anacostia Reg. Trail - TIGER	Direct	1
T4658	STP-8888(374)FY11 FA PR	Direct	20
T3941	Rehab 16th st over Military	Direct	78
MTL13	Material Testing	Indirect-MTEST	14
L5952	OAID/SNOW	Operating	50

LEDDA,PATRICK G

K0142	RESURFACE & UPGRADE WARD 5&6	Direct	8
-------	------------------------------	--------	---

NABU,DANIEL

T3939	Rehab 16th St over Military	Direct	12
K0226	Anacostia Reg. Trail - TIGER	Direct	3
22770	DEPARTMENT OF TRANSPORTATION	Indirect	59
MTL13	Material Testing	Indirect-MTEST	28
L5952	OAID/SNOW	Operating	49

NUR,ELMI ALI

T3941	Rehab 16th st over Military	Direct	2
-------	-----------------------------	--------	---

PHILLIP,CARLOS D

T4658	STP-8888(374)FY11 FA PR	Direct	32
T4561	8888(286)prg. mngt-awi	Direct	8
K0062	FA13 FA Pavement Restoration, NHS	Direct	16

SPICER,LAKIERA

CA524	Street & Bridge Admin	Indirect	16
L2001	PREVENTIVE & ROUTINE ROADWAY MAINTENENCE	Operating	147
L5POT	Pothole and Pavement Campaign	Operating	29

IPMA - Storm Water Management Branch

Name	Index	TITLE	Type	Total Hours
-------------	--------------	--------------	-------------	--------------------

UPCHURCH,MEREDI

T2904	FY03 LOCAL RECONST/RESURF/UPGRD WARD 6	Direct	2
K0205	PREVENT FLOOD IN BLOOMINGDALE	Direct	4
T4263	Intra District - MOU	Direct	90
K0503	Stormwater Project	Direct	74
T4561	8888(286)prg. mngt-awi	Direct	8
K0152	TAP - Green Alleys	Direct	6
L2002	PROJECT DEVELOPMENT AND MANAGEMENT	Operating	20

IPMA - Team 1

Name	Index	TITLE	Type	Total Hours
AGAH, GHOLAM A				
	K0123	CT AVE Stscape Pase III	Direct	8
	K0109	1116(032) Recons of FL Ave, NW	Direct	8
BROWN, TARIFA M				
	L5952	OAID/SNOW	Operating	2
BURNS, KEVIN C				
	22770	DEPARTMENT OF TRANSPORTATION	Indirect	41
HACKNEY, JEROME				
	22770	DEPARTMENT OF TRANSPORTATION	Indirect	10
PRINCE, MAURICE				
	T2888	Local Restr, resurf, upgr- W5	Direct	119
	K0123	CT AVE Stscape Pase III	Direct	109
	T4918	1102(030) K St ADA Improvement	Direct	26
RIZVI, MOHAMMED				
	D4001	Enterprise Fund, 6901, grants	Direct	10
	T4870	REHAB PA AVE BR OV RCK CRK PKW	Direct	4
	T4926	IM-0661(069)Theodore Roosevelt	Direct	26
SARABI, AIDIN REZA				
	K0074	CENTER LEG	Direct	8
	K0213	REHAB OF 1ST ST NE	Direct	60
SELLARS, JAMES O				
	T4966	C&O Canal Wall Capstone Rplmnt	Direct	17

IPMA - Team 2

Name	Index	TITLE	Type	Total Hours
-------------	--------------	--------------	-------------	--------------------

ADEYEMO,BABATU				
	T4805	Streetlight Asset Mgmt	Direct	18
	L5952	OAID/SNOW	Operating	6
AKINBOLAJO,FREDE				
	T4682	FY11 CW Stlight Asset Managememe	Direct	5
	T4805	Streetlight Asset Mgmt	Direct	42
	L5952	OAID/SNOW	Operating	52
DORRIZ,ZAHRA				
	K0381	Klinge Valley Trail	Direct	5
	T4890	CANAL RD	Direct	7
	L5952	OAID/SNOW	Operating	4
FREEMAN,STANLEY				
	K0342	27th St,NW ov Broad Branch Str	Direct	194
	T2816	FY03 NEW/REPAIR CURB/SDWLK/ALLEY WD 3&4	Direct	8
	T2904	FY03 LOCAL RECONST/RESURF/UPGRD WARD 6	Direct	8
	T3939	Rehab 16th St over Military	Direct	584
	T3941	Rehab 16th st over Military	Direct	26
	L5952	OAID/SNOW	Operating	29
HILL JR,OBRIENT				
	22770	DEPARTMENT OF TRANSPORTATION	Indirect	62
	CA582	INSP-Inspection & Investigation	Indirect	129
	L5POT	Pothole and Pavement Campaign	Operating	10
	L5684	POPE FRANCIS VISIT 2015	Operating	4
	L5952	OAID/SNOW	Operating	69
HYLTON,MODIBO K				
	T3910	FY08 CAPITAL PROJ PROFILE ESTABLISHMENT	Direct	24
	T2816	FY03 NEW/REPAIR CURB/SDWLK/ALLEY WD 3&4	Direct	247
	K0520	RALLY FOR ALLYS (ALLY PALOOZA)	Direct	134
	22770	DEPARTMENT OF TRANSPORTATION	Indirect	9
	L5952	OAID/SNOW	Operating	124
	L5POT	Pothole and Pavement Campaign	Operating	57
KEBEDE,DAWIT W				
	K0425	FY15 Ward 8 StreetScapes	Direct	2
	L5952	OAID/SNOW	Operating	28

LESTER, WILLIAM

K0520	RALLY FOR ALLYS (ALLY PALOOZA)	Direct	187
T3941	Rehab 16th st over Military	Direct	124
T2816	FY03 NEW/REPAIR CURB/SDWLK/ALLEY WD 3&4	Direct	21
22770	DEPARTMENT OF TRANSPORTATION	Indirect	8
L5POT	Pothole and Pavement Campaign	Operating	67

MONTENEGRO, FRA

T4658	STP-8888(374)FY11 FA PR	Direct	4
T4263	Intra District - MOU	Direct	10
T3941	Rehab 16th st over Military	Direct	28
T3939	Rehab 16th St over Military	Direct	341
T2880	FY03 LOCAL RECONST/RESURF/UPGRD WARD 2E	Direct	10
K0381	Klinge Valley Trail	Direct	45
K0342	27th St, NW ov Broad Branch Str	Direct	27

OGBEIDE, PATRICK O

L5952	OAID/SNOW	Operating	8
-------	-----------	-----------	---

SIBHATLEAB, GHIRM

T2904	FY03 LOCAL RECONST/RESURF/UPGRD WARD 6	Direct	16
K0204	Kennedy St Stscape	Direct	7
K0330	Missouri Kansas Kennedy	Direct	14
T2816	FY03 NEW/REPAIR CURB/SDWLK/ALLEY WD 3&4	Direct	3
22770	DEPARTMENT OF TRANSPORTATION	Indirect	6

STRANGE, ALFRED T

T3939	Rehab 16th St over Military	Direct	10
T2904	FY03 LOCAL RECONST/RESURF/UPGRD WARD 6	Direct	81
T2816	FY03 NEW/REPAIR CURB/SDWLK/ALLEY WD 3&4	Direct	12
22770	DEPARTMENT OF TRANSPORTATION	Indirect	6
L5952	OAID/SNOW	Operating	161
L5POT	Pothole and Pavement Campaign	Operating	52

IPMA - Team 3

Name	Index	TITLE	Type	Total Hours
ANANTH, SRINATH				
	T3910	FY08 CAPITAL PROJ PROFILE ESTABLISHMENT	Direct	30
	T4658	STP-8888(374)FY11 FA PR	Direct	45
	T2816	FY03 NEW/REPAIR CURB/SDWLK/ALLEY WD 3&4	Direct	222
	K0520	RALLY FOR ALLYS (ALLY PALOOZA)	Direct	167

BOWLES,NANNETTE				
	K0470	Capital Crossing Development	Direct	8
BYRD,ANTONIO				
	T4805	Streetlight Asset Mgmt	Direct	10
	L5952	OAID/SNOW	Operating	8
GANA,MATTHEW K				
	K0074	CENTER LEG	Direct	14
	K0470	Capital Crossing Development	Direct	57
NJEPU,ROMANUS				
	K0520	RALLY FOR ALLYS (ALLY PALOOZA)	Direct	212
	T2816	FY03 NEW/REPAIR CURB/SDWLK/ALLEY WD 3&4	Direct	382
	T3910	FY08 CAPITAL PROJ PROFILE ESTABLISHMENT	Direct	28
	L5POT	Pothole and Pavement Campaign	Operating	20
NORMAN,GAIL O				
	K0520	RALLY FOR ALLYS (ALLY PALOOZA)	Direct	35
	T2880	FY03 LOCAL RECONST/RESURF/UPGRD WARD 2E	Direct	147
PASSMORE,MAURIC				
	T4956	FY12 Guiderail and Attenuators	Direct	123
	T2816	FY03 NEW/REPAIR CURB/SDWLK/ALLEY WD 3&4	Direct	18
	K0520	RALLY FOR ALLYS (ALLY PALOOZA)	Direct	8
PRINCE,MORGAN T				
	K0213	REHAB OF 1ST ST NE	Direct	8
	L5952	OAID/SNOW	Operating	16
SHEFFIELD JR,EDMO				
	K0213	REHAB OF 1ST ST NE	Direct	24
	K0037	Reconst 1st St. Ne K st - NY A	Direct	16
	22770	DEPARTMENT OF TRANSPORTATION	Indirect	2
	L5952	OAID/SNOW	Operating	9
THOMPSON,ANGELI				
	T2888	Local Restr, resurf, upgr- W5	Direct	6

IPMA - Team 4

Name	Index	TITLE	Type	Total Hours
------	-------	-------	------	-------------

FOLAYAN,PHILLIPS				
	K0125	Rehab 6 Brs over Watts Branch	Direct	171
	22770	DEPARTMENT OF TRANSPORTATION	Indirect	2
	L5952	OAID/SNOW	Operating	30
	L5POT	Pothole and Pavement Campaign	Operating	5
IGHO-OSAGIE,OLABI				
	K0147	Revitalization MN Ave. Phase I	Direct	7
	K0332	49TH ST NE TRAFFIC CALM PROJ	Direct	113
	L5952	OAID/SNOW	Operating	2
JACKSON,ANTHONY				
	T4956	FY12 Guiderail and Attenuators	Direct	1
OLATUNJI,SAMUEL				
	K0290	15th St NW Safety Improvs	Direct	3
	T4395	Reconstr. Kenilworth Ave	Direct	9
	L5952	OAID/SNOW	Operating	17
SIRAGA,BRUK G				
	T2816	FY03 NEW/REPAIR CURB/SDWLK/ALLEY WD 3&4	Direct	10
	T4561	8888(286)prg. mngt-awi	Direct	288
	22770	DEPARTMENT OF TRANSPORTATION	Indirect	18
	L5952	OAID/SNOW	Operating	2
THOMPSON,ERIC L				
	T2816	FY03 NEW/REPAIR CURB/SDWLK/ALLEY WD 3&4	Direct	10
	T4805	Streetlight Asset Mgmt	Direct	5
TOYE,MONTEZ				
	K0224	Sheriff Rd,NE Safety Imprvs	Direct	20
	K0125	Rehab 6 Brs over Watts Branch	Direct	78
	22770	DEPARTMENT OF TRANSPORTATION	Indirect	43
	L5952	OAID/SNOW	Operating	140
	L5POT	Pothole and Pavement Campaign	Operating	92
UMEZURIKE,CHARL				
	K0147	Revitalization MN Ave. Phase I	Direct	40
	K0224	Sheriff Rd,NE Safety Imprvs	Direct	54
	K0332	49TH ST NE TRAFFIC CALM PROJ	Direct	20

Office of the Director - Administrative Services Branch

Name	Index	TITLE	Type	Total Hours
-------------	--------------	--------------	-------------	--------------------

AMPEDU,ERIC OSEI				
	L5952	OAID/SNOW	Operating	44
FLOWERS,RAMONO				
	L5952	OAID/SNOW	Operating	90
PATTERSON,SHARO				
	L5952	OAID/SNOW	Operating	9
POWELL,TANYA				
	L5952	OAID/SNOW	Operating	12
SMITH-MATHIS,LED				
	L5952	OAID/SNOW	Operating	71
	L1010	PERSONNEL	Operating	29
WALKER,CHARNITA				
	L5952	OAID/SNOW	Operating	72

Office of the Director - Civil Rights

Name	Index	TITLE	Type	Total Hours
KABIR,MOHAMMED				
	L5952	OAID/SNOW	Operating	103

Office of the Director - Communications

Name	Index	TITLE	Type	Total Hours
QUAY,CHRISTOPHE				
	L5680	Fourth of July - 2015	Operating	11
	L1080	COMMUNICATIONS	Operating	23

Office of the Director - Customer Service Call Center

Name	Index	TITLE	Type	Total Hours
HOLLIWAY,LONDON				
	CA522	RRES-Roadway Repair Section	Indirect	8
LILLY,KEVIN A				
	63970	DEPARTMENT OF TRANSPORTATION	Indirect	90

Office of the Director - Customer Service Clearinghouse

Name	Index	TITLE	Type	Total Hours
CLAROS,RUTH L				
	L1085	CUSTOMER SERVICE	Operating	36
LATTIMORE,JELANI				
	L5952	OAID/SNOW	Operating	2
	L1085	CUSTOMER SERVICE	Operating	200

PERKINS,PORTIA C

L5952	OAID/SNOW	Operating	65
L1085	CUSTOMER SERVICE	Operating	160
L5POT	Pothole and Pavement Campaign	Operating	84

SIMMS,MICHELLE M

L5680	Fourth of July - 2015	Operating	2
-------	-----------------------	-----------	---

WARE,AMANDA H

L1085	CUSTOMER SERVICE	Operating	30
-------	------------------	-----------	----

Office of the Director - Facilities Management

Name	Index	TITLE	Type	Total Hours
-------------	--------------	--------------	-------------	--------------------

BANKS,JULIE L

L1030	PROPERTY MANAGEMENT	Operating	40
-------	---------------------	-----------	----

DANIEL,PHILLIP

L5204	STBM/HEAVY EQUIPMENT OPERATIONS SECTION	Operating	78
-------	---	-----------	----

L5952	OAID/SNOW	Operating	77
-------	-----------	-----------	----

FREEMAN,ROBYN

63970	DEPARTMENT OF TRANSPORTATION	Indirect	20
-------	------------------------------	----------	----

L5952	OAID/SNOW	Operating	61
-------	-----------	-----------	----

GRANBERRY,GREGO

L1030	PROPERTY MANAGEMENT	Operating	131
-------	---------------------	-----------	-----

L5952	OAID/SNOW	Operating	62
-------	-----------	-----------	----

JOHNSON JR,HUBER

L1030	PROPERTY MANAGEMENT	Operating	58
-------	---------------------	-----------	----

L5952	OAID/SNOW	Operating	122
-------	-----------	-----------	-----

LOWE,CALVIN

L1030	PROPERTY MANAGEMENT	Operating	36
-------	---------------------	-----------	----

SIMMONS,GREGORY

CA524	Street & Bridge Admin	Indirect	8
-------	-----------------------	----------	---

L1030	PROPERTY MANAGEMENT	Operating	146
-------	---------------------	-----------	-----

L5952	OAID/SNOW	Operating	77
-------	-----------	-----------	----

Office of the Director - Human Capital Management

Name	Index	TITLE	Type	Total Hours
-------------	--------------	--------------	-------------	--------------------

FELDER,DONTE L

C1120	OD-Contracts	Indirect	24
-------	--------------	----------	----

L5952	OAID/SNOW	Operating	5
-------	-----------	-----------	---

MESSAM,STEVEN E

L5952 OAID/SNOW Operating 4

POLLARD,MARCUS

L5952 OAID/SNOW Operating 2

WINZOR,MALIKA

L5952 OAID/SNOW Operating 75

Office of the Director - OFFICE OF DIRECTOR

Name Index TITLE Type Total Hours

RHONES,AARON R

L5952 OAID/SNOW Operating 92

Office of the Director - Office of Emergency Preparedness

Name Index TITLE Type Total Hours

CARSON,ANTHONY

L5952 OAID/SNOW Operating 29

JONES,NATALIE E

L5952 OAID/SNOW Operating 27

L1555 RISK MANAGEMENT Operating 1

L5684 POPE FRANCIS VISIT 2015 Operating 14

WARD,BETTYE JEAN

L5952 OAID/SNOW Operating 31

L1555 RISK MANAGEMENT Operating 5

L5684 POPE FRANCIS VISIT 2015 Operating 9

Office of the Director - Office of the Director Support

Name Index TITLE Type Total Hours

BANKS,FELICIA L

L5952 OAID/SNOW Operating 8

HENDERSON,SANDR

L5952 OAID/SNOW Operating 24

Office of the Director - Training

Name Index TITLE Type Total Hours

ALSTON,CHARLOTT

L595T Snow Training Operating 10

L5952 OAID/SNOW Operating 141

FORGY,NICHOLE L

L5952 OAID/SNOW Operating 78

OITI - Applications & Development Supp

Name	Index	TITLE	Type	Total Hours
NIMMAGADDA,RAM				
	L1040	INFORMATION TECHNOLOGY	Operating	33
	L5952	OAID/SNOW	Operating	92
SHIVADHANAM,LEE				
	L5952	OAID/SNOW	Operating	92

OITI - DDOT IT Program Managers

Name	Index	TITLE	Type	Total Hours
ANYANWU,ISDORE				
	L1040	INFORMATION TECHNOLOGY	Operating	20
	L5952	OAID/SNOW	Operating	19
	L5680	Fourth of July - 2015	Operating	9

OITI - Geospatial Data Systems Division

Name	Index	TITLE	Type	Total Hours
GRAHAM,JAMES KN				
	L1040	INFORMATION TECHNOLOGY	Operating	30

OITI - Information Technology OITI

Name	Index	TITLE	Type	Total Hours
LAMONT,ELIZABET				
	L1040	INFORMATION TECHNOLOGY	Operating	65
	L5952	OAID/SNOW	Operating	114
NUNEZ DELA CRUZ,J				
	L1085	CUSTOMER SERVICE	Operating	7
WILSON,JONATHAN				
	63970	DEPARTMENT OF TRANSPORTATION	Indirect	54
	L1040	INFORMATION TECHNOLOGY	Operating	117
	L5952	OAID/SNOW	Operating	105

OITI - Infrastructure & Customer Supp

Name	Index	TITLE	Type	Total Hours
ALI,RASHEED I				
	L1040	INFORMATION TECHNOLOGY	Operating	5
	L5952	OAID/SNOW	Operating	10

DIXON,MARLENE P

L5673	Concert for Valor	Operating	3
L5684	POPE FRANCIS VISIT 2015	Operating	13
L5952	OAID/SNOW	Operating	14
L1040	INFORMATION TECHNOLOGY	Operating	76

FISH,TURNESHA J

L5POT	Pothole and Pavement Campaign	Operating	3
L5952	OAID/SNOW	Operating	72

HILL,GREER

L1090	PERFORMANCE MANAGEMENT	Operating	3
-------	------------------------	-----------	---

HIRED,KHALIF

L5952	OAID/SNOW	Operating	62
-------	-----------	-----------	----

KHAN,FAISAL A

L5680	Fourth of July - 2015	Operating	3
-------	-----------------------	-----------	---

SAID,MOHAMED M

L5952	OAID/SNOW	Operating	82
L1040	INFORMATION TECHNOLOGY	Operating	9

PPSA - Highway Safety, Research & Tec

Name	Index	TITLE	Type	Total Hours
GAY,KAREN M	L5952	OAID/SNOW	Operating	106
	L4005	PERMIT	Operating	99

PPSA - Plan Review & Compliance Divis

Name	Index	TITLE	Type	Total Hours
FIELDS,DELOIS D	L5952	OAID/SNOW	Operating	18

PPSA - Policy Branch

Name	Index	TITLE	Type	Total Hours
PEREZ,BENITO O	L5952	OAID/SNOW	Operating	84

PPSA - State Planning Branch

Name	Index	TITLE	Type	Total Hours
CLECKLEY,EULOIS E	L5952	OAID/SNOW	Operating	28

PSRA - Customer Service

Name	Index	TITLE	Type	Total Hours
-------------	--------------	--------------	-------------	--------------------

BENSON,TALAT

CA582	INSP-Inspection & Investigation	Indirect	14
L5952	OAID/SNOW	Operating	38

DOGGETT,QUARTNE

L7050	DEPARTMENT OF TRANSPORTATION	Operating	403
L5POT	Pothole and Pavement Campaign	Operating	344
L5952	OAID/SNOW	Operating	69
L5680	Fourth of July - 2015	Operating	14

GREEN,DOMANIKA

L7100	DEPARTMENT OF TRANSPORTATION	Operating	24
-------	------------------------------	-----------	----

GRIER,PAMELA P

L5POT	Pothole and Pavement Campaign	Operating	48
L7100	DEPARTMENT OF TRANSPORTATION	Operating	150

YOUMANS,LAVAR

L7100	DEPARTMENT OF TRANSPORTATION	Operating	4
-------	------------------------------	-----------	---

PSRA - Inspections

Name	Index	TITLE	Type	Total Hours
BALL,CHERYL B	L5802	SIOD/INSPECTIONS AND INVESTIGATIONS	Operating	7
BLUNT,GARY L	L7021	DEPARTMENT OF TRANSPORTATION	Operating	197
	L5POT	Pothole and Pavement Campaign	Operating	36
CARRAWAY JR,PAU	L59RT	Red Top Meter Assessment	Operating	10
CHILDS,JAMES	L7023	DEPARTMENT OF TRANSPORTATION	Operating	70
	L5POT	Pothole and Pavement Campaign	Operating	20
	L5952	OAID/SNOW	Operating	10
COLLINS,STACEY C	L5673	Concert for Valor	Operating	7
	L5680	Fourth of July - 2015	Operating	14
	L5952	OAID/SNOW	Operating	8
	L5POT	Pothole and Pavement Campaign	Operating	162
	L3043	DEPARTMENT OF TRANSPORTATION	Operating	8
	L7021	DEPARTMENT OF TRANSPORTATION	Operating	175
	L59RT	Red Top Meter Assessment	Operating	28

GARRETT,ELLIOTT				
L7023	DEPARTMENT OF TRANSPORTATION	Operating		138
L5POT	Pothole and Pavement Campaign	Operating		119
GRAHAM,WALTER K				
L7100	DEPARTMENT OF TRANSPORTATION	Operating		91
L5952	OAID/SNOW	Operating		17
L5POT	Pothole and Pavement Campaign	Operating		90
HENRY,JAMES T				
L7022	DEPARTMENT OF TRANSPORTATION	Operating		194
L5POT	Pothole and Pavement Campaign	Operating		200
L59RT	Red Top Meter Assessment	Operating		30
L5952	OAID/SNOW	Operating		86
L5673	Concert for Valor	Operating		9
L3043	DEPARTMENT OF TRANSPORTATION	Operating		20
HILL JR,DAVID W				
L7022	DEPARTMENT OF TRANSPORTATION	Operating		166
L5POT	Pothole and Pavement Campaign	Operating		129
L59RT	Red Top Meter Assessment	Operating		10
L5952	OAID/SNOW	Operating		30
JERNAGIN,MICHAEL				
L7022	DEPARTMENT OF TRANSPORTATION	Operating		162
L5POT	Pothole and Pavement Campaign	Operating		20
L5673	Concert for Valor	Operating		7
L3043	DEPARTMENT OF TRANSPORTATION	Operating		8
KING,CHARLES				
T4254	Thermoplastic Pavement Marking	Direct		220
L7022	DEPARTMENT OF TRANSPORTATION	Operating		177
L5952	OAID/SNOW	Operating		105
LEE,ROBERT K				
L5POT	Pothole and Pavement Campaign	Operating		28
L7022	DEPARTMENT OF TRANSPORTATION	Operating		130

MATTHEWS,VACAR				
L5680	Fourth of July - 2015	Operating		14
L7023	DEPARTMENT OF TRANSPORTATION	Operating		86
L5POT	Pothole and Pavement Campaign	Operating		93
L59RT	Red Top Meter Assessment	Operating		30
L5673	Concert for Valor	Operating		7
MCFADDEN,MARVI				
L3043	DEPARTMENT OF TRANSPORTATION	Operating		16
L59RT	Red Top Meter Assessment	Operating		30
L5POT	Pothole and Pavement Campaign	Operating		265
L5952	OAID/SNOW	Operating		171
L5680	Fourth of July - 2015	Operating		14
L5673	Concert for Valor	Operating		9
L7023	DEPARTMENT OF TRANSPORTATION	Operating		329
MCLEOD,RAYMOND				
L5POT	Pothole and Pavement Campaign	Operating		8
L7022	DEPARTMENT OF TRANSPORTATION	Operating		102
NORRIS,DWAYNE K				
L7021	DEPARTMENT OF TRANSPORTATION	Operating		176
L3043	DEPARTMENT OF TRANSPORTATION	Operating		7
L5680	Fourth of July - 2015	Operating		14
L5952	OAID/SNOW	Operating		4
L59RT	Red Top Meter Assessment	Operating		10
L5POT	Pothole and Pavement Campaign	Operating		60
OBADARE,OLUWAS				
L5POT	Pothole and Pavement Campaign	Operating		4
POWELL,ANDRE D				
L5952	OAID/SNOW	Operating		11
L7023	DEPARTMENT OF TRANSPORTATION	Operating		4
L5POT	Pothole and Pavement Campaign	Operating		12
PROCTOR,EDGAR R				
L5952	OAID/SNOW	Operating		15
L7023	DEPARTMENT OF TRANSPORTATION	Operating		15

RICHARDSON,HAYW

L7023	DEPARTMENT OF TRANSPORTATION	Operating	110
L5POT	Pothole and Pavement Campaign	Operating	76
L59RT	Red Top Meter Assessment	Operating	22
L5952	OAID/SNOW	Operating	82
L5673	Concert for Valor	Operating	9

STEWART,DONNA M

L7100	DEPARTMENT OF TRANSPORTATION	Operating	30
L5952	OAID/SNOW	Operating	6

SUMMERS,MILDRED

L59RT	Red Top Meter Assessment	Operating	30
L5680	Fourth of July - 2015	Operating	14
L5POT	Pothole and Pavement Campaign	Operating	141
L7021	DEPARTMENT OF TRANSPORTATION	Operating	70
L5673	Concert for Valor	Operating	7

TATE,RONALD L

L5680	Fourth of July - 2015	Operating	10
L5POT	Pothole and Pavement Campaign	Operating	12
L7022	DEPARTMENT OF TRANSPORTATION	Operating	34

TOYER,KENNETH J

L7023	DEPARTMENT OF TRANSPORTATION	Operating	152
-------	------------------------------	-----------	-----

TURNER,NATHANIE

L59RT	Red Top Meter Assessment	Operating	30
L5POT	Pothole and Pavement Campaign	Operating	166
L5952	OAID/SNOW	Operating	3
L7022	DEPARTMENT OF TRANSPORTATION	Operating	180

WELLS,DAVID

L7021	DEPARTMENT OF TRANSPORTATION	Operating	273
L59RT	Red Top Meter Assessment	Operating	35
L5POT	Pothole and Pavement Campaign	Operating	122
L5952	OAID/SNOW	Operating	95

WHITE,ROBERT L

L5POT	Pothole and Pavement Campaign	Operating	8
L7023	DEPARTMENT OF TRANSPORTATION	Operating	194
L5673	Concert for Valor	Operating	9
L59RT	Red Top Meter Assessment	Operating	30

PSRA - Permits

Name	Index	TITLE	Type	Total Hours
EDWARDS,BERNAD	L7100	DEPARTMENT OF TRANSPORTATION	Operating	18
FELDER,CATRINA I	L7030	DEPARTMENT OF TRANSPORTATION	Operating	44
	L5952	OAID/SNOW	Operating	38
GAMIL,YASSER M	L5POT	Pothole and Pavement Campaign	Operating	176
	L5ALY	Rally for the Alley	Operating	58
	L7030	DEPARTMENT OF TRANSPORTATION	Operating	103
HARRIS,MALINDA G	L5POT	Pothole and Pavement Campaign	Operating	8
	L7030	DEPARTMENT OF TRANSPORTATION	Operating	13
JONES,SHANNON RE	L5952	OAID/SNOW	Operating	6
	L7030	DEPARTMENT OF TRANSPORTATION	Operating	54
	L5ALY	Rally for the Alley	Operating	112
MORRIS,FRANKLIN	L7030	DEPARTMENT OF TRANSPORTATION	Operating	12
PEARSON,CURTIS R	L7030	DEPARTMENT OF TRANSPORTATION	Operating	89
SOMERVILLE-BRUC	L7030	DEPARTMENT OF TRANSPORTATION	Operating	20
	L5POT	Pothole and Pavement Campaign	Operating	24
STEVENS,JOHN A	L5POT	Pothole and Pavement Campaign	Operating	48

PSRA - Plan Review

Name	Index	TITLE	Type	Total Hours
ALLEN,KISHA	L5POT	Pothole and Pavement Campaign	Operating	12
	L7040	Plan and Review	Operating	2
	L7041	DEPARTMENT OF TRANSPORTATION	Operating	38

DICKENS,CHARLENE

22770	DEPARTMENT OF TRANSPORTATION	Indirect	12
L5684	POPE FRANCIS VISIT 2015	Operating	6
L5680	Fourth of July - 2015	Operating	10
L5673	Concert for Valor	Operating	3
L5POT	Pothole and Pavement Campaign	Operating	48

EDOKWE,EDWIN

L5952	OAID/SNOW	Operating	14
L5POT	Pothole and Pavement Campaign	Operating	48

MEADERS,KEENAN

L7041	DEPARTMENT OF TRANSPORTATION	Operating	78
L5POT	Pothole and Pavement Campaign	Operating	260

PETROSIAN,LEVON

L7050	DEPARTMENT OF TRANSPORTATION	Operating	8
-------	------------------------------	-----------	---

STOKES,JOHN

L7030	DEPARTMENT OF TRANSPORTATION	Operating	8
-------	------------------------------	-----------	---

ZAMANI,ALI A

L5POT	Pothole and Pavement Campaign	Operating	24
-------	-------------------------------	-----------	----

PTSA - Mass Transit Division

Name	Index	TITLE	Type	Total Hours
BUNDY,ANTHONY C				
	L5952	OAID/SNOW	Operating	65
JOHNSON,ANGELICA				
	L5952	OAID/SNOW	Operating	4

PTSA - StreetCar Development Division

Name	Index	TITLE	Type	Total Hours
BARYSHEV,KLARA				
	32770	DEPARTMENT OF TRANSPORTATION	Indirect	21
CHISM,JOHN P				
	T4085	StreetCars	Direct	184
	32770	DEPARTMENT OF TRANSPORTATION	Indirect	14
	L5952	OAID/SNOW	Operating	58

PTSA - Transportation Business Unit

Name	Index	TITLE	Type	Total Hours
------	-------	-------	------	-------------

RICH,VICTORY J

L3002	MASS TRANSIT	Operating	13
L5952	OAID/SNOW	Operating	132

Resource Management - Resource Management

Name	Index	TITLE	Type	Total Hours
-------------	--------------	--------------	-------------	--------------------

COVINGTON,RONAL

L1050	FINACIAL MANAGEMENT	Operating	8
-------	---------------------	-----------	---

DANIEL,PHILLIP S

T4901	8888(400) Audit and Compliance	Direct	8
L5952	OAID/SNOW	Operating	89

LOVE,LAKISHA

T4901	8888(400) Audit and Compliance	Direct	3
L5952	OAID/SNOW	Operating	3
L1050	FINACIAL MANAGEMENT	Operating	4

RUPERT,LEZLIE GRE

L5952	OAID/SNOW	Operating	16
-------	-----------	-----------	----

VIATONU,OLUWAKE

L5952	OAID/SNOW	Operating	11
-------	-----------	-----------	----

TOA - Alley Paving Unit

Name	Index	TITLE	Type	Total Hours
-------------	--------------	--------------	-------------	--------------------

BELL JR,THOMAS H

L5952	OAID/SNOW	Operating	122
-------	-----------	-----------	-----

MATHIS,REGINALD

L595T	Snow Training	Operating	4
L5952	OAID/SNOW	Operating	119
L5204	STBM/HEAVY EQUIPMENT OPERATIONS SECTION	Operating	14

MORRIS,ROBERT H

K0161	Street and Alley Maint & Repair	Direct	13
CA521	RMAS-Roadway Maint Section	Indirect	42
L595T	Snow Training	Operating	4
L5680	Fourth of July - 2015	Operating	12
L5POT	Pothole and Pavement Campaign	Operating	86
L5952	OAID/SNOW	Operating	113
L5673	Concert for Valor	Operating	4

ROSS,TRITTY K

CA521	RMAS-Roadway Maint Section	Indirect	105
L5POT	Pothole and Pavement Campaign	Operating	56
L5952	OAID/SNOW	Operating	3

WILLIAMS,ANDREA

T4478	Concrete, Asphalt & Bridge Mnt	Direct	7
CA521	RMAS-Roadway Maint Section	Indirect	26
L595T	Snow Training	Operating	4
L5POT	Pothole and Pavement Campaign	Operating	26
L5673	Concert for Valor	Operating	4
L5952	OAID/SNOW	Operating	96

TOA - Automated Graphic & Design Fab

Name	Index	TITLE	Type	Total Hours
THOMAS,HAROLD A				
	T4254	Thermoplastic Pavement Marking	Direct	28
	CA516	FAVR-Sign Fabrication	Indirect	32
	CA511	SIGW-Sign Inst, Remvl Ward 1-8	Indirect	62

WANZER,JAMIE

T4254	Thermoplastic Pavement Marking	Direct	18
CA516	FAVR-Sign Fabrication	Indirect	56

TOA - Bridge & Street Maintenance

Name	Index	TITLE	Type	Total Hours
BURNETTE,ANTONI				
	L595T	Snow Training	Operating	9
	L5204	STBM/HEAVY EQUIPMENT OPERATIONS SECTION	Operating	169
	L5684	POPE FRANCIS VISIT 2015	Operating	18
	L5952	OAID/SNOW	Operating	143
	L5POT	Pothole and Pavement Campaign	Operating	9
CALLAHAM,ROBERT				
	L595T	Snow Training	Operating	4
	L5952	OAID/SNOW	Operating	82
	L5684	POPE FRANCIS VISIT 2015	Operating	16
	L5204	STBM/HEAVY EQUIPMENT OPERATIONS SECTION	Operating	16
	L5021	TSFO - FLEET MANAGEMENT	Operating	96
	L5POT	Pothole and Pavement Campaign	Operating	191

GLASPIE,JAMES H				
L5802	SIOD/INSPECTIONS AND INVESTIGATIONS	Operating	16	
HINTON,LAMONT A				
L5203	TSFO/ADMIN SUPPORT	Operating	86	
L5952	OAID/SNOW	Operating	39	
JACKSON,MICHAEL				
CA521	RMAS-Roadway Maint Section	Indirect	8	
L5POT	Pothole and Pavement Campaign	Operating	138	
L5684	POPE FRANCIS VISIT 2015	Operating	8	
L595T	Snow Training	Operating	4	
L5952	OAID/SNOW	Operating	119	
L5204	STBM/HEAVY EQUIPMENT OPERATIONS SECTION	Operating	87	
LUCAS,CHALL A				
L5952	OAID/SNOW	Operating	21	
L595T	Snow Training	Operating	4	
L5802	SIOD/INSPECTIONS AND INVESTIGATIONS	Operating	22	
MARSHALL,CELICIA				
L5952	OAID/SNOW	Operating	56	
L595T	Snow Training	Operating	5	
MCKINNEY,RICARD				
22770	DEPARTMENT OF TRANSPORTATION	Indirect	156	
L5952	OAID/SNOW	Operating	84	
L5684	POPE FRANCIS VISIT 2015	Operating	4	
L5POT	Pothole and Pavement Campaign	Operating	4	
MILLER,LORENZO O				
L5005	TSFO/WAREHOUSE SECTION	Operating	119	
L5POT	Pothole and Pavement Campaign	Operating	181	
L5952	OAID/SNOW	Operating	139	
L5684	POPE FRANCIS VISIT 2015	Operating	10	
PETTUS,ANGELA L				
L5952	OAID/SNOW	Operating	72	

SALMON,WILLIE M

K0161	Street and Alley Maint & Repair	Direct	93
CA521	RMAS-Roadway Maint Section	Indirect	204
L5952	OAID/SNOW	Operating	4
L5POT	Pothole and Pavement Campaign	Operating	6
L5684	POPE FRANCIS VISIT 2015	Operating	9

SMITH,KENNETH W

L5676	State of the Union FY2015	Operating	4
L5201	TSFO/RODWAY REPAIR SECTION	Operating	99
L5952	OAID/SNOW	Operating	83
L5680	Fourth of July - 2015	Operating	12
L5POT	Pothole and Pavement Campaign	Operating	42

SMITH,ROBERT E

CA574	SSIG-Signals	Indirect	265
L5952	OAID/SNOW	Operating	66
L5POT	Pothole and Pavement Campaign	Operating	33

SYKES,CLARENCE R

L5952	OAID/SNOW	Operating	129
L5684	POPE FRANCIS VISIT 2015	Operating	9
L5POT	Pothole and Pavement Campaign	Operating	206
L595T	Snow Training	Operating	9
L5204	STBM/HEAVY EQUIPMENT OPERATIONS SECTION	Operating	279
L5673	Concert for Valor	Operating	4

TENBROOK,CHARLE

L5POT	Pothole and Pavement Campaign	Operating	19
L5952	OAID/SNOW	Operating	60

TOA - Bridge Operations Unit

Name	Index	TITLE	Type	Total Hours
DAWKINS,MICHAEL				
	L5659	Baseball FY2014	Operating	12
	L5952	OAID/SNOW	Operating	139
	L595T	Snow Training	Operating	4
	L5201	TSFO/RODWAY REPAIR SECTION	Operating	22
	L5684	POPE FRANCIS VISIT 2015	Operating	8

FLORANCE,JONAS J

L5952	OAID/SNOW	Operating	55
L595T	Snow Training	Operating	4
L5202	STBM/ROADWAY MAINTENANCE SECTION	Operating	5

JACKSON,GARY J

L5201	TSFO/RODWAY REPAIR SECTION	Operating	127
L5POT	Pothole and Pavement Campaign	Operating	122
L595T	Snow Training	Operating	4
L5952	OAID/SNOW	Operating	119
L5684	POPE FRANCIS VISIT 2015	Operating	8

JACKSON,LAWRENC

T4477	Bridge Operation and Maintenance	Direct	17
CA522	RRES-Roadway Repair Section	Indirect	4
L5952	OAID/SNOW	Operating	92
L5659	Baseball FY2014	Operating	12

MCNEELY,ROBERT

T4477	Bridge Operation and Maintenance	Direct	4
K0122	8888434 TRUCK SIZE AND WEIGHT	Direct	7
CA522	RRES-Roadway Repair Section	Indirect	45
L5952	OAID/SNOW	Operating	84

PHILLIPS,CORNELIO

L5201	TSFO/RODWAY REPAIR SECTION	Operating	83
L5684	POPE FRANCIS VISIT 2015	Operating	4
L5POT	Pothole and Pavement Campaign	Operating	28
L5952	OAID/SNOW	Operating	96
L595T	Snow Training	Operating	4
L5659	Baseball FY2014	Operating	12

SIMPSON,TENSLY

L5201	TSFO/RODWAY REPAIR SECTION	Operating	54
L5676	State of the Union FY2015	Operating	4
L5952	OAID/SNOW	Operating	94
L5673	Concert for Valor	Operating	4
L595T	Snow Training	Operating	4
L5POT	Pothole and Pavement Campaign	Operating	8
L5684	POPE FRANCIS VISIT 2015	Operating	4

TAYLOR JR,JULIUS

L5201	TSFO/RODWAY REPAIR SECTION	Operating	244
L5659	Baseball FY2014	Operating	12
L595T	Snow Training	Operating	4
L5POT	Pothole and Pavement Campaign	Operating	170
L5952	OAID/SNOW	Operating	83

TAYLOR,ROBERT

T4477	Bridge Operation and Maintenance	Direct	17
L5201	TSFO/RODWAY REPAIR SECTION	Operating	0
L5952	OAID/SNOW	Operating	71

WHEELER,KEONNE

L5201	TSFO/RODWAY REPAIR SECTION	Operating	113
L5952	OAID/SNOW	Operating	138

WILSON,MICHAEL E

L595T	Snow Training	Operating	4
L5201	TSFO/RODWAY REPAIR SECTION	Operating	204
L5952	OAID/SNOW	Operating	99
L5POT	Pothole and Pavement Campaign	Operating	141
L5684	POPE FRANCIS VISIT 2015	Operating	4

TOA - City-Wide Division

Name	Index	TITLE	Type	Total Hours
BAGA,CHERWIN L				
	T4805	Streetlight Asset Mgmt	Direct	45
	CA582	INSP-Inspection & Investigation	Indirect	5
	L5952	OAID/SNOW	Operating	42
LYLE,JERRY L				
	L5902	CWPS/PARKING OPERATIONS	Operating	30
	L5952	OAID/SNOW	Operating	80
PATTERSON,EVIAN				
	L5903	CWPS/ADMIN SUPPORT	Operating	64
	L5952	OAID/SNOW	Operating	48
PUGH,LORENZO D				
	L5684	POPE FRANCIS VISIT 2015	Operating	4
TURNER,RICHARD D				
	L5802	SIOD/INSPECTIONS AND INVESTIGATIONS	Operating	2

TOA - Crack Seal Unit

Name	Index	TITLE	Type	Total Hours
CHAPPELLE,BARRIN				
	L5673	Concert for Valor	Operating	4
	L5680	Fourth of July - 2015	Operating	12
	L5952	OAID/SNOW	Operating	66
	L595T	Snow Training	Operating	4
	L5POT	Pothole and Pavement Campaign	Operating	197
	L5204	STBM/HEAVY EQUIPMENT OPERATIONS SECTION	Operating	179
GRIMES,ROBERT D				
	K0161	Street and Alley Maint & Repair	Direct	50
	CA521	RMAS-Roadway Maint Section	Indirect	116
	L5POT	Pothole and Pavement Campaign	Operating	83
	L5680	Fourth of July - 2015	Operating	12
	L5952	OAID/SNOW	Operating	93
LOTT,JOANELL S				
	CA521	RMAS-Roadway Maint Section	Indirect	6
	L5680	Fourth of July - 2015	Operating	12
	L595T	Snow Training	Operating	10
	L5201	TSFO/RODWAY REPAIR SECTION	Operating	101
	L5676	State of the Union FY2015	Operating	4
	L5684	POPE FRANCIS VISIT 2015	Operating	13
	L5POT	Pothole and Pavement Campaign	Operating	8
	L5952	OAID/SNOW	Operating	101
WILLIS,BARBARA J				
	K0161	Street and Alley Maint & Repair	Direct	65
	CA521	RMAS-Roadway Maint Section	Indirect	118
	L5680	Fourth of July - 2015	Operating	12
	L5952	OAID/SNOW	Operating	64
	L5POT	Pothole and Pavement Campaign	Operating	228

TOA - Equipment Maintenance Unit

Name	Index	TITLE	Type	Total Hours
-------------	--------------	--------------	-------------	--------------------

BAXTER,DONALD

CA521	RMAS-Roadway Maint Section	Indirect	371
L5676	State of the Union FY2015	Operating	4
L5680	Fourth of July - 2015	Operating	20
L5684	POPE FRANCIS VISIT 2015	Operating	12
L5952	OAID/SNOW	Operating	140
L5673	Concert for Valor	Operating	4
L5POT	Pothole and Pavement Campaign	Operating	182

TOA - Fleet Management

Name	Index	TITLE	Type	Total Hours
-------------	--------------	--------------	-------------	--------------------

DAVIS,VICKI

L5021	TSFO - FLEET MANAGEMENT	Operating	5
-------	-------------------------	-----------	---

TOA - Heavy Equipment Operations Sec

Name	Index	TITLE	Type	Total Hours
-------------	--------------	--------------	-------------	--------------------

HAZEL,ROBERT D

L5POT	Pothole and Pavement Campaign	Operating	92
L5204	STBM/HEAVY EQUIPMENT OPERATIONS SECTION	Operating	166
L5684	POPE FRANCIS VISIT 2015	Operating	8
L595T	Snow Training	Operating	4
L5952	OAID/SNOW	Operating	152

TOA - ITS Support Traffic Signals &

Name	Index	TITLE	Type	Total Hours
-------------	--------------	--------------	-------------	--------------------

CARMICHAEL,REGIN

K0155	FY13 Traffic Signal Maintenanc	Direct	12
K0153	FY13 Traffic Signal Maintenanc	Direct	4
L5952	OAID/SNOW	Operating	74

COOPER,TAWEH H

T4918	1102(030) K St ADA Improvement	Direct	70
CA513	TRSS-Traffic Signal Section	Indirect	4
L5680	Fourth of July - 2015	Operating	12
L5952	OAID/SNOW	Operating	151

HARVIN,CHERYL

K0074	CENTER LEG	Direct	12
T4918	1102(030) K St ADA Improvement	Direct	88
K0123	CT AVE Stscape Pase III	Direct	16
T4561	8888(286)prg. mngt-awi	Direct	1

JOHNSON,JERMAINE

K0153	FY13 Traffic Signal Maintenanc	Direct	1
T4918	1102(030) K St ADA Improvement	Direct	48
T4254	Thermoplastic Pavement Marking	Direct	88
K0155	FY13 Traffic Signal Maintenanc	Direct	2
L5680	Fourth of July - 2015	Operating	12
L5952	OAID/SNOW	Operating	35

LINDSAY,QUINN

T4918	1102(030) K St ADA Improvement	Direct	72
K0470	Capital Crossing Development	Direct	19
K0123	CT AVE Stscape Pase III	Direct	16
K0074	CENTER LEG	Direct	12
CA513	TRSS-Traffic Signal Section	Indirect	16

PATTERSON,CORBIN

K0074	CENTER LEG	Direct	12
K0123	CT AVE Stscape Pase III	Direct	12
T4918	1102(030) K St ADA Improvement	Direct	54
CA513	TRSS-Traffic Signal Section	Indirect	8
L5952	OAID/SNOW	Operating	83
L5680	Fourth of July - 2015	Operating	12

TAYLOR,CHAUNCEY

T4918	1102(030) K St ADA Improvement	Direct	12
K0353	12th,ME,Fish Market (Wharf)	Direct	2
K0470	Capital Crossing Development	Direct	11

TOA - ITS Systems Support Branch

Name	Index	TITLE	Type	Total Hours
ROYAL,JAMES				
	T4918	1102(030) K St ADA Improvement	Direct	12
	L5002	TSFO/TRAFFIC SIGNAL SECTION	Operating	4

TOA - Layout Crew

Name	Index	TITLE	Type	Total Hours
COX,CAROL Y				
	L5202	STBM/ROADWAY MAINTENANCE SECTION	Operating	48
	L5952	OAID/SNOW	Operating	4
	L5POT	Pothole and Pavement Campaign	Operating	44

HART,RODNEY L

T4254	Thermoplastic Pavement Marking	Direct	207
CA512	PAVW-Pavmt Mrking Ward 1-8	Indirect	142
L5952	OAID/SNOW	Operating	52

TOA - Maintainer Unit

Name	Index	TITLE	Type	Total Hours
-------------	--------------	--------------	-------------	--------------------

MODENESSI I,VICTO

K0161	Street and Alley Maint & Repair	Direct	30
CA522	RRES-Roadway Repair Section	Indirect	98
L595T	Snow Training	Operating	4
L5POT	Pothole and Pavement Campaign	Operating	131
L5952	OAID/SNOW	Operating	32

NELSON,MICHAEL J

L5204	STBM/HEAVY EQUIPMENT OPERATIONS SECTION	Operating	260
L5POT	Pothole and Pavement Campaign	Operating	176
L595T	Snow Training	Operating	18
L5952	OAID/SNOW	Operating	120
L5684	POPE FRANCIS VISIT 2015	Operating	18

TREADWELL,JOHNNI

L5POT	Pothole and Pavement Campaign	Operating	4
-------	-------------------------------	-----------	---

TOA - Milling/Spray Patch Unit

Name	Index	TITLE	Type	Total Hours
-------------	--------------	--------------	-------------	--------------------

GAINES,ARMELL

T4478	Concrete, Asphalt & Bridge Mnt	Direct	6
CA521	RMAS-Roadway Maint Section	Indirect	89
L5680	Fourth of July - 2015	Operating	12
L5684	POPE FRANCIS VISIT 2015	Operating	22
L5POT	Pothole and Pavement Campaign	Operating	50
L5952	OAID/SNOW	Operating	74

GROSS,MYRON

CA522	RRES-Roadway Repair Section	Indirect	67
L5952	OAID/SNOW	Operating	47
L5POT	Pothole and Pavement Campaign	Operating	92
L5680	Fourth of July - 2015	Operating	12
L5684	POPE FRANCIS VISIT 2015	Operating	10

JOHNSON,DONALD E

L5ALY	Rally for the Alley	Operating	3
L595T	Snow Training	Operating	4
L5952	OAID/SNOW	Operating	85
L5684	POPE FRANCIS VISIT 2015	Operating	4
L5POT	Pothole and Pavement Campaign	Operating	116
L5659	Baseball FY2014	Operating	12
L5201	TSFO/RODWAY REPAIR SECTION	Operating	185

LANCASTER,CLIFFO

L5201	TSFO/RODWAY REPAIR SECTION	Operating	214
L5ALY	Rally for the Alley	Operating	3
L5684	POPE FRANCIS VISIT 2015	Operating	5
L5POT	Pothole and Pavement Campaign	Operating	112
L5952	OAID/SNOW	Operating	83
L595T	Snow Training	Operating	4

MILLER,ANTHONY D

T4478	Concrete, Asphalt & Bridge Mnt	Direct	68
CA522	RRES-Roadway Repair Section	Indirect	244
L5POT	Pothole and Pavement Campaign	Operating	182
L595T	Snow Training	Operating	4
L5952	OAID/SNOW	Operating	79
L5680	Fourth of July - 2015	Operating	12
L5684	POPE FRANCIS VISIT 2015	Operating	8

MILLER,GEORGE J

L5202	STBM/ROADWAY MAINTENANCE SECTION	Operating	11
L5684	POPE FRANCIS VISIT 2015	Operating	12
L5952	OAID/SNOW	Operating	126
L595T	Snow Training	Operating	4
L5POT	Pothole and Pavement Campaign	Operating	86
L5204	STBM/HEAVY EQUIPMENT OPERATIONS SECTION	Operating	50

WHEELER,BENJAMI

L595T	Snow Training	Operating	5
L5952	OAID/SNOW	Operating	117
L5201	TSFO/RODWAY REPAIR SECTION	Operating	45

TOA - Office of the Associate Direct

Name	Index	TITLE	Type	Total Hours
-------------	--------------	--------------	-------------	--------------------

MULDROW,KIM L

L5951	OAID/ADMIN SUPPORT	Operating	144
L5680	Fourth of July - 2015	Operating	8
L5POT	Pothole and Pavement Campaign	Operating	107

TOA - Parking Operations Branch

Name	Index	TITLE	Type	Total Hours
MILLER,MICHAEL T				
	L5902	CWPS/PARKING OPERATIONS	Operating	137
	L5952	OAID/SNOW	Operating	88

TOA - Pavement Marking Crew

Name	Index	TITLE	Type	Total Hours
RICHARDSON,LEMA				
	T4254	Thermoplastic Pavement Marking	Direct	108
	CA512	PAVW-Pavmt Mrking Ward 1-8	Indirect	94
WILKS,TODD SYLVE				
	T4254	Thermoplastic Pavement Marking	Direct	212
	CA512	PAVW-Pavmt Mrking Ward 1-8	Indirect	168
	L5952	OAID/SNOW	Operating	96

TOA - Paving Unit

Name	Index	TITLE	Type	Total Hours
BROWN,MICHAEL L				
	CA521	RMAS-Roadway Maint Section	Indirect	140
	L5POT	Pothole and Pavement Campaign	Operating	148
	L5ALY	Rally for the Alley	Operating	3
	L5952	OAID/SNOW	Operating	70
CLAYTON,JAMES				
	L595T	Snow Training	Operating	4
	L5201	TSFO/RODWAY REPAIR SECTION	Operating	26
	L5952	OAID/SNOW	Operating	109
HOLMAN,TERRI B				
	L5204	STBM/HEAVY EQUIPMENT OPERATIONS SECTION	Operating	66
	L5POT	Pothole and Pavement Campaign	Operating	92
	L595T	Snow Training	Operating	4
	L5952	OAID/SNOW	Operating	48
	L5684	POPE FRANCIS VISIT 2015	Operating	4

JACKSON,GARRETT

L5680	Fourth of July - 2015	Operating	12
L5684	POPE FRANCIS VISIT 2015	Operating	4
L595T	Snow Training	Operating	4
L5201	TSFO/RODWAY REPAIR SECTION	Operating	10
L5952	OAID/SNOW	Operating	116
L5POT	Pothole and Pavement Campaign	Operating	62

SHORT,RASHAAD D

L5POT	Pothole and Pavement Campaign	Operating	8
L595T	Snow Training	Operating	14
L5659	Baseball FY2014	Operating	12
L5680	Fourth of July - 2015	Operating	12
L5204	STBM/HEAVY EQUIPMENT OPERATIONS SECTION	Operating	133
L5684	POPE FRANCIS VISIT 2015	Operating	14
L5952	OAID/SNOW	Operating	130

THOMPSON JR,LUCU

L5952	OAID/SNOW	Operating	20
L5ALY	Rally for the Alley	Operating	3
L5POT	Pothole and Pavement Campaign	Operating	20
L5684	POPE FRANCIS VISIT 2015	Operating	8
L5204	STBM/HEAVY EQUIPMENT OPERATIONS SECTION	Operating	92

TOA - Roadway Maintenance Section

Name	Index	TITLE	Type	Total Hours
JONES,ROLAND D				
	L5201	TSFO/RODWAY REPAIR SECTION	Operating	158
	L595T	Snow Training	Operating	4
	L5952	OAID/SNOW	Operating	127
	L5676	State of the Union FY2015	Operating	4
	L5POT	Pothole and Pavement Campaign	Operating	120
	L5673	Concert for Valor	Operating	4

TOA - Roadway Operations Branch

Name	Index	TITLE	Type	Total Hours
BROOKS,KEVIN L				
	T4908	ROADWAY OP PATROL	Direct	20
	CA520	Roadway Operations Unit	Indirect	32

DEARING,MICHELE				
T4908	ROADWAY OP PATROL	Direct		8
L5402	TOTM/TRAFFIC CONTROL OPERATIONS	Operating		39
L5952	OAID/SNOW	Operating		9
L5680	Fourth of July - 2015	Operating		8
FIELDS,WARREN L				
T4908	ROADWAY OP PATROL	Direct		109
T4805	Streetlight Asset Mgmt	Direct		5
L5673	Concert for Valor	Operating		4
HONESTY-BEY,CHIE				
T4908	ROADWAY OP PATROL	Direct		33
L5673	Concert for Valor	Operating		4
MAKLE JR,ALBERT				
T4908	ROADWAY OP PATROL	Direct		16
CA520	Roadway Operations Unit	Indirect		25
MASON,BRADLEY L				
T4908	ROADWAY OP PATROL	Direct		123
L5673	Concert for Valor	Operating		4
MCCREA,DONNA J				
T4908	ROADWAY OP PATROL	Direct		1
CA520	Roadway Operations Unit	Indirect		46
L5POT	Pothole and Pavement Campaign	Operating		8
RILEY,SIGBEE D				
T4908	ROADWAY OP PATROL	Direct		89
SHANNON,ERIC A				
T4908	ROADWAY OP PATROL	Direct		30
T4805	Streetlight Asset Mgmt	Direct		11
CA520	Roadway Operations Unit	Indirect		108
L5673	Concert for Valor	Operating		8
SKEEN,TYRONE				
T4908	ROADWAY OP PATROL	Direct		149
CA520	Roadway Operations Unit	Indirect		8
L5673	Concert for Valor	Operating		12
L5684	POPE FRANCIS VISIT 2015	Operating		5

WARREN,DARREN R

T4805	Streetlight Asset Mgmt	Direct	5
T4908	ROADWAY OP PATROL	Direct	12
CA520	Roadway Operations Unit	Indirect	107
L5684	POPE FRANCIS VISIT 2015	Operating	16

WILSON,JEREMY B

T4805	Streetlight Asset Mgmt	Direct	9
T4908	ROADWAY OP PATROL	Direct	24
CA520	Roadway Operations Unit	Indirect	133
L5673	Concert for Valor	Operating	4

TOA - Safety Standard & Oversight

Name	Index	TITLE	Type	Total Hours
-------------	--------------	--------------	-------------	--------------------

ANDERSON,LEON

K0470	Capital Crossing Development	Direct	6
CA573	SAFE-Safety Team	Indirect	11

HARDY SR,DERRICK

L5POT	Pothole and Pavement Campaign	Operating	48
L5952	OAID/SNOW	Operating	4

JAIN,RAHUL P

K0457	Strategic Planning	Direct	7
T4519	CW ROAD SFTY AUDIT PROGRAM	Direct	62
K0463	Traffic Safety Data Collection	Direct	4
CA573	SAFE-Safety Team	Indirect	31
L5952	OAID/SNOW	Operating	56

MILES,KENDRICK M

CA573	SAFE-Safety Team	Indirect	4
L5POT	Pothole and Pavement Campaign	Operating	12
L5952	OAID/SNOW	Operating	86

TOA - School Crossing Control Progra

Name	Index	TITLE	Type	Total Hours
-------------	--------------	--------------	-------------	--------------------

AMBROSE,KENDRA

L5401	TOTM/SCHOOL CROSSING GUARD	Operating	69
L5659	Baseball FY2014	Operating	9
L5677	FY15 Baseball	Operating	83

BROWN,GRACIE

L5401	TOTM/SCHOOL CROSSING GUARD	Operating	17
-------	----------------------------	-----------	----

BURNETT,PHYLLIS S				
L5680	Fourth of July - 2015	Operating		4
L5401	TOTM/SCHOOL CROSSING GUARD	Operating		17
BUTLER,HELEN				
L5677	FY15 Baseball	Operating		58
L5401	TOTM/SCHOOL CROSSING GUARD	Operating		26
L5659	Baseball FY2014	Operating		8
CASEY,JACQUELINE				
L5659	Baseball FY2014	Operating		1
L5677	FY15 Baseball	Operating		32
COPELAND,DOMINI				
L5659	Baseball FY2014	Operating		8
L5677	FY15 Baseball	Operating		126
L5401	TOTM/SCHOOL CROSSING GUARD	Operating		116
DAVIS,LOUISE				
L5401	TOTM/SCHOOL CROSSING GUARD	Operating		4
L5677	FY15 Baseball	Operating		6
DONLEY,SHAUGHN				
T4908	ROADWAY OP PATROL	Direct		20
L5401	TOTM/SCHOOL CROSSING GUARD	Operating		15
EDWARDS,ROBERT				
L5680	Fourth of July - 2015	Operating		4
L5401	TOTM/SCHOOL CROSSING GUARD	Operating		1
FORD SR,MICHAEL P				
L5401	TOTM/SCHOOL CROSSING GUARD	Operating		23
L5659	Baseball FY2014	Operating		2
L5677	FY15 Baseball	Operating		50
GRAHAM,SHEZZELL				
L5401	TOTM/SCHOOL CROSSING GUARD	Operating		27
GRAY,EDWINA R				
L5677	FY15 Baseball	Operating		18
GREELY,BRENDELL				
L5401	TOTM/SCHOOL CROSSING GUARD	Operating		5
L5677	FY15 Baseball	Operating		5

GRIFFIN,BILLY				
T4908	ROADWAY OP PATROL	Direct		19
L5677	FY15 Baseball	Operating		19
L5401	TOTM/SCHOOL CROSSING GUARD	Operating		55
L5659	Baseball FY2014	Operating		13
HALL,EDWARD S				
L5401	TOTM/SCHOOL CROSSING GUARD	Operating		7
HALL,JENNIFER R				
L5POT	Pothole and Pavement Campaign	Operating		226
L5ALY	Rally for the Alley	Operating		4
L5680	Fourth of July - 2015	Operating		22
L5673	Concert for Valor	Operating		9
L7100	DEPARTMENT OF TRANSPORTATION	Operating		307
HARROD,GREGORY				
L5677	FY15 Baseball	Operating		1
L5401	TOTM/SCHOOL CROSSING GUARD	Operating		4
HILLIAN,MARY				
L5677	FY15 Baseball	Operating		88
L5659	Baseball FY2014	Operating		8
L5401	TOTM/SCHOOL CROSSING GUARD	Operating		123
HINSON,DARLENE E				
L5401	TOTM/SCHOOL CROSSING GUARD	Operating		2
L5677	FY15 Baseball	Operating		0
HOLLOMAN,LATOY				
L5401	TOTM/SCHOOL CROSSING GUARD	Operating		2
HOLMES,SHARON				
L5401	TOTM/SCHOOL CROSSING GUARD	Operating		24
L5677	FY15 Baseball	Operating		55
L5684	POPE FRANCIS VISIT 2015	Operating		1
L5659	Baseball FY2014	Operating		6
HORTON,SHANIKA				
L5401	TOTM/SCHOOL CROSSING GUARD	Operating		17
L5659	Baseball FY2014	Operating		14
L5677	FY15 Baseball	Operating		16

HOWE,SHIRLEY A				
L5659	Baseball FY2014	Operating		1
L5677	FY15 Baseball	Operating		10
L5401	TOTM/SCHOOL CROSSING GUARD	Operating		5
HUMES,DEIDRE				
L5401	TOTM/SCHOOL CROSSING GUARD	Operating		19
L5677	FY15 Baseball	Operating		36
HUNTER,JAMES				
L5401	TOTM/SCHOOL CROSSING GUARD	Operating		5
L5402	TOTM/TRAFFIC CONTROL OPERATIONS	Operating		79
L5677	FY15 Baseball	Operating		4
L5680	Fourth of July - 2015	Operating		12
JOHNSON,MARION				
T4908	ROADWAY OP PATROL	Direct		47
L5952	OAID/SNOW	Operating		12
JONES,DARLENE G				
L5659	Baseball FY2014	Operating		7
LEE,ANGELA				
L5680	Fourth of July - 2015	Operating		12
L5677	FY15 Baseball	Operating		5
L5402	TOTM/TRAFFIC CONTROL OPERATIONS	Operating		124
LEWIS,TONYA C				
L5677	FY15 Baseball	Operating		14
MAYO,MARSHA BEA				
L5677	FY15 Baseball	Operating		27
L5401	TOTM/SCHOOL CROSSING GUARD	Operating		12
MCPHATTER,ALICE				
L5677	FY15 Baseball	Operating		8
MILLARD,ANTOINET				
L5401	TOTM/SCHOOL CROSSING GUARD	Operating		123
L5677	FY15 Baseball	Operating		64
MITCHELL,KENNET				
L5677	FY15 Baseball	Operating		16
L5401	TOTM/SCHOOL CROSSING GUARD	Operating		26

MORTON,PATRICIA				
L5401	TOTM/SCHOOL CROSSING GUARD	Operating		36
L5677	FY15 Baseball	Operating		89
L5684	POPE FRANCIS VISIT 2015	Operating		6
NICKENS,APRIL L				
L5677	FY15 Baseball	Operating		4
PERRY,ANNIE KATH				
L5677	FY15 Baseball	Operating		16
L5401	TOTM/SCHOOL CROSSING GUARD	Operating		10
PYLES,SHARON D				
L5677	FY15 Baseball	Operating		18
L5401	TOTM/SCHOOL CROSSING GUARD	Operating		1
REDD,MATTIE L				
L5401	TOTM/SCHOOL CROSSING GUARD	Operating		13
L5659	Baseball FY2014	Operating		19
THOMAS,AISHA				
L5401	TOTM/SCHOOL CROSSING GUARD	Operating		4
THOMAS,KAREEMA				
L5401	TOTM/SCHOOL CROSSING GUARD	Operating		8
L5677	FY15 Baseball	Operating		21
WATSON,LONNIE R				
L5401	TOTM/SCHOOL CROSSING GUARD	Operating		4
WILKINSON,DARREL				
L5POT	Pothole and Pavement Campaign	Operating		171
L5952	OAID/SNOW	Operating		20
L5201	TSFO/RODWAY REPAIR SECTION	Operating		74
WILLIAMS,CHARLEN				
L5659	Baseball FY2014	Operating		8
L5677	FY15 Baseball	Operating		24
L5401	TOTM/SCHOOL CROSSING GUARD	Operating		10
WILLIAMS,MARQUE				
L5677	FY15 Baseball	Operating		82
L5659	Baseball FY2014	Operating		8
L5401	TOTM/SCHOOL CROSSING GUARD	Operating		158

WOMBLE,EARL L

L5401	TOTM/SCHOOL CROSSING GUARD	Operating	12
L5659	Baseball FY2014	Operating	2
L5677	FY15 Baseball	Operating	23

WRIGHT,FAYE T

L5401	TOTM/SCHOOL CROSSING GUARD	Operating	2
-------	----------------------------	-----------	---

TOA - Sidewalk/Concrete Brick Mainte

Name	Index	TITLE	Type	Total Hours
-------------	--------------	--------------	-------------	--------------------

BELL,ANTHONY

L595T	Snow Training	Operating	4
L5204	STBM/HEAVY EQUIPMENT OPERATIONS SECTION	Operating	79
L5952	OAID/SNOW	Operating	53
L5659	Baseball FY2014	Operating	12
L5POT	Pothole and Pavement Campaign	Operating	77

COATES,MATHEW H

L5952	OAID/SNOW	Operating	68
L595T	Snow Training	Operating	4
L5POT	Pothole and Pavement Campaign	Operating	90
L5202	STBM/ROADWAY MAINTENANCE SECTION	Operating	230

JONES,STEVEN W

L5POT	Pothole and Pavement Campaign	Operating	129
L5952	OAID/SNOW	Operating	131
L5202	STBM/ROADWAY MAINTENANCE SECTION	Operating	149

SIMS,DEAN

L5202	STBM/ROADWAY MAINTENANCE SECTION	Operating	216
L5201	TSFO/RODWAY REPAIR SECTION	Operating	4
L5POT	Pothole and Pavement Campaign	Operating	136
L595T	Snow Training	Operating	4
L5952	OAID/SNOW	Operating	88

TOA - Sign Installation Team (Teams

Name	Index	TITLE	Type	Total Hours
-------------	--------------	--------------	-------------	--------------------

BARNES,LEON C

T4984	Street Sign Improvments	Direct	86
L5952	OAID/SNOW	Operating	74

BERRY,JAMES S				
T4254	Thermoplastic Pavement Marking	Direct	16	
T4984	Street Sign Improvments	Direct	159	
L5952	OAID/SNOW	Operating	75	
L595T	Snow Training	Operating	4	
CLAGGETT,ERIC A				
T4984	Street Sign Improvments	Direct	44	
T4254	Thermoplastic Pavement Marking	Direct	74	
CA511	SIGW-Sign Inst, Remvl Ward 1-8	Indirect	85	
L5952	OAID/SNOW	Operating	16	
COLE,CARLOS DAM				
T4984	Street Sign Improvments	Direct	48	
L5952	OAID/SNOW	Operating	26	
GASTON,LAVALLE E				
T4254	Thermoplastic Pavement Marking	Direct	26	
T4984	Street Sign Improvments	Direct	85	
JAKES,PHYLLIS				
T4254	Thermoplastic Pavement Marking	Direct	46	
T4984	Street Sign Improvments	Direct	46	
CA511	SIGW-Sign Inst, Remvl Ward 1-8	Indirect	81	
L5674	Marion Barry's Celebration	Operating	4	
JAMES,DION L				
T4984	Street Sign Improvments	Direct	42	
T4254	Thermoplastic Pavement Marking	Direct	8	
LEWIS,YAZID				
T4984	Street Sign Improvments	Direct	95	
T4254	Thermoplastic Pavement Marking	Direct	36	
L5952	OAID/SNOW	Operating	67	
LOCUS,ARTHUR L				
T4984	Street Sign Improvments	Direct	8	
MILLER JR,EDWARD				
T4984	Street Sign Improvments	Direct	124	
T4254	Thermoplastic Pavement Marking	Direct	28	
L5952	OAID/SNOW	Operating	34	

PAYTON,ROBERT L

T4984	Street Sign Improvments	Direct	100
L5674	Marion Barry's Celebration	Operating	4
L5952	OAID/SNOW	Operating	83

PHILSON,MAURICE

T4984	Street Sign Improvments	Direct	64
T4254	Thermoplastic Pavement Marking	Direct	16
L5952	OAID/SNOW	Operating	5

RICHARDSON,MAUR

T4984	Street Sign Improvments	Direct	175
T4254	Thermoplastic Pavement Marking	Direct	54
L5952	OAID/SNOW	Operating	20

STREET,JASON

T4254	Thermoplastic Pavement Marking	Direct	28
T4984	Street Sign Improvments	Direct	69

WILSON,WILLIAM E

T4984	Street Sign Improvments	Direct	101
L5952	OAID/SNOW	Operating	37

TOA - Sign Painting Crew

Name	Index	TITLE	Type	Total Hours
REED,SHELLEY D				
	T4254	Thermoplastic Pavement Marking	Direct	102
	CA511	SIGW-Sign Inst, Remvl Ward 1-8	Indirect	8
	CA516	FAVR-Sign Fabrication	Indirect	106
	L5952	OAID/SNOW	Operating	93
SAUNDERS-JONES,D				
	T4254	Thermoplastic Pavement Marking	Direct	60
	T4984	Street Sign Improvments	Direct	36
	CA521	RMAS-Roadway Maint Section	Indirect	8
	CA516	FAVR-Sign Fabrication	Indirect	99
	CA512	PAVW-Pavmt Mrking Ward 1-8	Indirect	26
	L5952	OAID/SNOW	Operating	135
WAHAB,MOHAMMA				
	T4254	Thermoplastic Pavement Marking	Direct	36
	CA516	FAVR-Sign Fabrication	Indirect	97

TOA - Speed Hump Unit

Name	Index	TITLE	Type	Total Hours
ELLERBE,KEITH R				
	K0161	Street and Alley Maint & Repair	Direct	55
	CA521	RMAS-Roadway Maint Section	Indirect	102
	L5680	Fourth of July - 2015	Operating	12
	L5POT	Pothole and Pavement Campaign	Operating	97
	L5ALY	Rally for the Alley	Operating	3
	L5952	OAID/SNOW	Operating	30
	L5673	Concert for Valor	Operating	4
ELLIS,DANIEL				
	L5204	STBM/HEAVY EQUIPMENT OPERATIONS SECTION	Operating	154
	L5659	Baseball FY2014	Operating	12
	L5684	POPE FRANCIS VISIT 2015	Operating	32
	L5952	OAID/SNOW	Operating	102
	L5POT	Pothole and Pavement Campaign	Operating	38
FERRELL,DONALD A				
	CA521	RMAS-Roadway Maint Section	Indirect	114
	L5POT	Pothole and Pavement Campaign	Operating	64
	L5952	OAID/SNOW	Operating	65
	L5204	STBM/HEAVY EQUIPMENT OPERATIONS SECTION	Operating	20
HOES,LAWRENCE E				
	L5680	Fourth of July - 2015	Operating	12
	L5952	OAID/SNOW	Operating	21
	L5POT	Pothole and Pavement Campaign	Operating	4
ROSEBAR,RICHARD				
	CA521	RMAS-Roadway Maint Section	Indirect	229
	L5POT	Pothole and Pavement Campaign	Operating	232
	L5ALY	Rally for the Alley	Operating	3
	L595T	Snow Training	Operating	4
	L5680	Fourth of July - 2015	Operating	12
	L5952	OAID/SNOW	Operating	91

SILVA,JOSE C

CA521	RMAS-Roadway Maint Section	Indirect	30
L5684	POPE FRANCIS VISIT 2015	Operating	10
L5952	OAID/SNOW	Operating	78
L5POT	Pothole and Pavement Campaign	Operating	28

TOA - Streetlight Operations Branch

Name	Index	TITLE	Type	Total Hours
GROSS,STEVEN				
	T4805	Streetlight Asset Mgmt	Direct	43
	L5952	OAID/SNOW	Operating	66
HUNTLEY,ALLEN P				
	L5673	Concert for Valor	Operating	1
	L5952	OAID/SNOW	Operating	89
KENNEY,BRENDA L				
	T4684	FY11 CW Stlight Asset Manageme	Direct	10
	T4682	FY11 CW Stlight Asset Manageme	Direct	8
	T4805	Streetlight Asset Mgmt	Direct	18
	L5952	OAID/SNOW	Operating	130
LAWSON,ANTHONY				
	K0122	8888434 TRUCK SIZE AND WEIGHT	Direct	8
	CA593	STLG-Street Light Operation	Indirect	42
NGUYEN,TAN H				
	T4805	Streetlight Asset Mgmt	Direct	14
	T4682	FY11 CW Stlight Asset Manageme	Direct	15
	L5952	OAID/SNOW	Operating	110
	L5684	POPE FRANCIS VISIT 2015	Operating	7
SCHOOLS,JOHN J				
	T4684	FY11 CW Stlight Asset Manageme	Direct	4
	T4805	Streetlight Asset Mgmt	Direct	10
	CA593	STLG-Street Light Operation	Indirect	167
	L5952	OAID/SNOW	Operating	109

TOA - System Inspection & Oversight

Name	Index	TITLE	Type	Total Hours
-------------	--------------	--------------	-------------	--------------------

EDMONDS,FRANCIN

CA512	PAVW-Pavmt Mrking Ward 1-8	Indirect	18
L5010	TSFO- ADMIN SUPPORT	Operating	96
L5POT	Pothole and Pavement Campaign	Operating	71

HENDERSON,ANTAN

L5952	OAID/SNOW	Operating	25
L5801	SIOD/ADMIN SUPPORT	Operating	18

TOA - TOA

Name	Index	TITLE	Type	Total Hours
ALEXANDER JR,HAR				
	T4918	1102(030) K St ADA Improvement	Direct	12
	L5680	Fourth of July - 2015	Operating	12
BROWDER,CLARK K				
	T4918	1102(030) K St ADA Improvement	Direct	36
	T4324	8888(360)Traffic Signal Optim	Direct	6
	T4910	ITS MAINTENANCE	Direct	28
	L5680	Fourth of July - 2015	Operating	12
	L5684	POPE FRANCIS VISIT 2015	Operating	12
COOPER,RANDOLPH				
	T4918	1102(030) K St ADA Improvement	Direct	112
	K0054	Closing of C St SW 2nd - Wash	Direct	10
	K0470	Capital Crossing Development	Direct	11
	K0123	CT AVE Stscape Pase III	Direct	12
	K0074	CENTER LEG	Direct	12
	CA510	TSAS - Admin Support	Indirect	4
	L5952	OAID/SNOW	Operating	86
DAVIS,GEORGE O				
	CA575	SUPP-System Support	Indirect	22
ELEKWACHI,OGECHE				
	T4324	8888(360)Traffic Signal Optim	Direct	3
	T4909	ITS INTEGRATION DEV	Direct	3
GARCIA,IVAN A				
	T4918	1102(030) K St ADA Improvement	Direct	12

JONES,TAMMIE

T4910	ITS MAINTENANCE	Direct	8
CA524	Street & Bridge Admin	Indirect	8
L595T	Snow Training	Operating	12
L5680	Fourth of July - 2015	Operating	12
L5952	OAID/SNOW	Operating	124

MALLOY JR,JOSEPH

T4910	ITS MAINTENANCE	Direct	20
T4918	1102(030) K St ADA Improvement	Direct	36
CA574	SSIG-Signals	Indirect	10
L5680	Fourth of July - 2015	Operating	12

NGUYEN,HUNG C

T4910	ITS MAINTENANCE	Direct	22
L5680	Fourth of July - 2015	Operating	12

NIXON,JIMMY R

K0470	Capital Crossing Development	Direct	16
T4324	8888(360)Traffic Signal Optim	Direct	11
T4910	ITS MAINTENANCE	Direct	11
L5952	OAID/SNOW	Operating	109
L5659	Baseball FY2014	Operating	7
L5677	FY15 Baseball	Operating	226
L5681	Taylor Swift Concert	Operating	12
L5684	POPE FRANCIS VISIT 2015	Operating	9
L5682	Zac Brown Concert	Operating	6

ROBINSON,RAY

T4909	ITS INTEGRATION DEV	Direct	10
K0122	8888434 TRUCK SIZE AND WEIGHT	Direct	10
T4324	8888(360)Traffic Signal Optim	Direct	12
CA574	SSIG-Signals	Indirect	13

SALAH,ABDI-SALAM

L5952	OAID/SNOW	Operating	52
-------	-----------	-----------	----

SILER,NORMAN V

K0123	CT AVE Stscape Pase III	Direct	12
T4918	1102(030) K St ADA Improvement	Direct	12
T4547	FY10 Traffic Signal Construction	Direct	12
CA572	System Intg. & Development	Indirect	34

THOMAS,JEROME

T1761	STP-1116(026)RECN BENNING RD. NE,16TH-OK	Direct	4
CA575	SUPP-System Support	Indirect	12
L5680	Fourth of July - 2015	Operating	12

WALLER,ROBERT A

T4324	8888(360)Traffic Signal Optim	Direct	6
T4547	FY10 Traffic Signal Construction	Direct	24
T4918	1102(030) K St ADA Improvement	Direct	24
T4910	ITS MAINTENANCE	Direct	40
L5680	Fourth of July - 2015	Operating	12
L5677	FY15 Baseball	Operating	6
L5682	Zac Brown Concert	Operating	6
L5684	POPE FRANCIS VISIT 2015	Operating	12

WOOD,JOSE R

T4909	ITS INTEGRATION DEV	Direct	15
T4324	8888(360)Traffic Signal Optim	Direct	15
K0470	Capital Crossing Development	Direct	20
L5683	Citi Open Tennis Classic	Operating	12
L5684	POPE FRANCIS VISIT 2015	Operating	6
L5673	Concert for Valor	Operating	3
L5952	OAID/SNOW	Operating	49
L5680	Fourth of July - 2015	Operating	12
L5675	Christmas Tree Lighting	Operating	4
L5659	Baseball FY2014	Operating	46
L5677	FY15 Baseball	Operating	210

TOA - Traffic Calming City-Wide

Name	Index	TITLE	Type	Total Hours
BANKS,SHERRIE				
	L5802	SIOD/INSPECTIONS AND INVESTIGATIONS	Operating	110
BHATIA,SANDEEP SI				
	CA582	INSP-Inspection & Investigation	Indirect	52
	L5952	OAID/SNOW	Operating	82
BRISCOE,SONYA L				
	CA582	INSP-Inspection & Investigation	Indirect	4

NICKENS WATSON,A

L5POT	Pothole and Pavement Campaign	Operating	41
L5802	SIOD/INSPECTIONS AND INVESTIGATIONS	Operating	244

SMITH,DARRELL E

CA582	INSP-Inspection & Investigation	Indirect	69
-------	---------------------------------	----------	----

TOA - Traffic Calming Wards 1, 2, 3

Name	Index	TITLE	Type	Total Hours
-------------	--------------	--------------	-------------	--------------------

ARNO,TIANEKA P

K0520	RALLY FOR ALLYS (ALLY PALOOZA)	Direct	19
T2816	FY03 NEW/REPAIR CURB/SDWLK/ALLEY WD 3&4	Direct	18
CA582	INSP-Inspection & Investigation	Indirect	17

CARTER,VINCENT E

CA582	INSP-Inspection & Investigation	Indirect	20
-------	---------------------------------	----------	----

HASSAN,MOHAMUD

CA582	INSP-Inspection & Investigation	Indirect	196
-------	---------------------------------	----------	-----

MASON,KENNETH B

CA582	INSP-Inspection & Investigation	Indirect	197
L5952	OAID/SNOW	Operating	4
L5POT	Pothole and Pavement Campaign	Operating	28

TOA - Traffic Calming Wards 5, 6, 7

Name	Index	TITLE	Type	Total Hours
-------------	--------------	--------------	-------------	--------------------

MARROW,DERRICK

T2816	FY03 NEW/REPAIR CURB/SDWLK/ALLEY WD 3&4	Direct	8
CA582	INSP-Inspection & Investigation	Indirect	144
L5POT	Pothole and Pavement Campaign	Operating	9
L5952	OAID/SNOW	Operating	21

WIGGINS,TERRAINE

L5952	OAID/SNOW	Operating	30
L5POT	Pothole and Pavement Campaign	Operating	27

TOA - Traffic Control Officers & Sch

Name	Index	TITLE	Type	Total Hours
-------------	--------------	--------------	-------------	--------------------

BURNS,CERAY

L5402	TOTM/TRAFFIC CONTROL OPERATIONS	Operating	156
L5677	FY15 Baseball	Operating	10
L5952	OAID/SNOW	Operating	108
L5673	Concert for Valor	Operating	12

BUTLER,SARAH				
L5673	Concert for Valor	Operating		2
L5402	TOTM/TRAFFIC CONTROL OPERATIONS	Operating		104
L5952	OAID/SNOW	Operating		81
L5684	POPE FRANCIS VISIT 2015	Operating		11
L5677	FY15 Baseball	Operating		17
L5674	Marion Barry's Celebration	Operating		25
DAVIS THOMAS,JAC				
L5952	OAID/SNOW	Operating		119
L5711	ITSO/ADMIN SUPPORTS	Operating		8
L595T	Snow Training	Operating		11
DIAL,LAMONT				
L5952	OAID/SNOW	Operating		69
L5402	TOTM/TRAFFIC CONTROL OPERATIONS	Operating		49
L5673	Concert for Valor	Operating		12
ELLIS,GENEVA E				
L5684	POPE FRANCIS VISIT 2015	Operating		9
L5952	OAID/SNOW	Operating		93
L5402	TOTM/TRAFFIC CONTROL OPERATIONS	Operating		16
L5674	Marion Barry's Celebration	Operating		12
L5673	Concert for Valor	Operating		2
MORGAN,KENITA N				
L5673	Concert for Valor	Operating		2
L5402	TOTM/TRAFFIC CONTROL OPERATIONS	Operating		5
L5952	OAID/SNOW	Operating		41
STRANGE,JAMES E				
L5683	Citi Open Tennis Classic	Operating		13
L5201	TSFO/RODWAY REPAIR SECTION	Operating		38
THWEATT,DENA R				
L5402	TOTM/TRAFFIC CONTROL OPERATIONS	Operating		24
L5677	FY15 Baseball	Operating		14
L5680	Fourth of July - 2015	Operating		12

WREN-PERKINS,NET

L5402	TOTM/TRAFFIC CONTROL OPERATIONS	Operating	137
L5684	POPE FRANCIS VISIT 2015	Operating	16
L5952	OAID/SNOW	Operating	108
L5673	Concert for Valor	Operating	12

TOA - Traffic Control Officers Progr

Name	Index	TITLE	Type	Total Hours
<hr/>				
ADDISON,ETHEL N				
	L5952	OAID/SNOW	Operating	48
<hr/>				
AMBROSE,ERIC A				
	L5673	Concert for Valor	Operating	4
	L5677	FY15 Baseball	Operating	115
	L5659	Baseball FY2014	Operating	25
	L5402	TOTM/TRAFFIC CONTROL OPERATIONS	Operating	244
<hr/>				
BAILEY,LACRESHA				
	L5402	TOTM/TRAFFIC CONTROL OPERATIONS	Operating	24
<hr/>				
BAILEY,TYREESE M				
	L5684	POPE FRANCIS VISIT 2015	Operating	4
	L5402	TOTM/TRAFFIC CONTROL OPERATIONS	Operating	46
<hr/>				
BAUMGARDNER,ARI				
	L5673	Concert for Valor	Operating	12
	L5402	TOTM/TRAFFIC CONTROL OPERATIONS	Operating	26
<hr/>				
BEEKS,WANDA				
	L5674	Marion Barry's Celebration	Operating	20
	L5673	Concert for Valor	Operating	4
	L5680	Fourth of July - 2015	Operating	10
	L5402	TOTM/TRAFFIC CONTROL OPERATIONS	Operating	131
<hr/>				
BLANDING,ASHLEY				
	L5402	TOTM/TRAFFIC CONTROL OPERATIONS	Operating	35
	L5674	Marion Barry's Celebration	Operating	19
	L5684	POPE FRANCIS VISIT 2015	Operating	8
	L5952	OAID/SNOW	Operating	44

BLOUNT JR,MILTON				
K0123	CT AVE Stscape Pase III	Direct		5
L5673	Concert for Valor	Operating		12
L5402	TOTM/TRAFFIC CONTROL OPERATIONS	Operating		90
L5680	Fourth of July - 2015	Operating		1
L5684	POPE FRANCIS VISIT 2015	Operating		2
L5952	OAID/SNOW	Operating		117
BOARDLEY,RAMON				
L5402	TOTM/TRAFFIC CONTROL OPERATIONS	Operating		85
L5673	Concert for Valor	Operating		12
L5677	FY15 Baseball	Operating		8
L5684	POPE FRANCIS VISIT 2015	Operating		2
BRICE,GEORGE M				
L5952	OAID/SNOW	Operating		25
L5402	TOTM/TRAFFIC CONTROL OPERATIONS	Operating		28
BRITTON,CONEICE J				
L5402	TOTM/TRAFFIC CONTROL OPERATIONS	Operating		52
L5952	OAID/SNOW	Operating		20
BROOKS,SHAHEDA				
L5684	POPE FRANCIS VISIT 2015	Operating		8
BUTLER,QUINTINA R				
L5680	Fourth of July - 2015	Operating		9
L5402	TOTM/TRAFFIC CONTROL OPERATIONS	Operating		12
CATO,PRESTON L				
L5674	Marion Barry's Celebration	Operating		20
L5673	Concert for Valor	Operating		2
L5402	TOTM/TRAFFIC CONTROL OPERATIONS	Operating		37
CHASE,JOYCE H				
L5402	TOTM/TRAFFIC CONTROL OPERATIONS	Operating		106
L5673	Concert for Valor	Operating		4
L5684	POPE FRANCIS VISIT 2015	Operating		12
CLAGGETT,DELONT				
L5402	TOTM/TRAFFIC CONTROL OPERATIONS	Operating		60
L5673	Concert for Valor	Operating		12
L5952	OAID/SNOW	Operating		90

CRAIG,CIERRA M				
L5674	Marion Barry's Celebration	Operating		12
L5952	OAID/SNOW	Operating		75
L5673	Concert for Valor	Operating		4
L5402	TOTM/TRAFFIC CONTROL OPERATIONS	Operating		57
DANIEL,ISAIAH				
L5402	TOTM/TRAFFIC CONTROL OPERATIONS	Operating		48
DAVIS,RONETTA				
L5677	FY15 Baseball	Operating		7
L5952	OAID/SNOW	Operating		41
L5673	Concert for Valor	Operating		2
L5402	TOTM/TRAFFIC CONTROL OPERATIONS	Operating		27
DAVIS,RUQAYYA R				
L5674	Marion Barry's Celebration	Operating		12
L5402	TOTM/TRAFFIC CONTROL OPERATIONS	Operating		78
DURHAM,ALVIN C				
L5402	TOTM/TRAFFIC CONTROL OPERATIONS	Operating		47
DYSON,DIMITRI				
L5402	TOTM/TRAFFIC CONTROL OPERATIONS	Operating		4
EDWARDS,KEVIN				
L5673	Concert for Valor	Operating		2
L5402	TOTM/TRAFFIC CONTROL OPERATIONS	Operating		69
L5952	OAID/SNOW	Operating		14
L5674	Marion Barry's Celebration	Operating		18
ELLINGTON,TRACEY				
L5952	OAID/SNOW	Operating		54
L5674	Marion Barry's Celebration	Operating		8
L5402	TOTM/TRAFFIC CONTROL OPERATIONS	Operating		42
FIELDS,AMBER MAR				
L5952	OAID/SNOW	Operating		49
L5673	Concert for Valor	Operating		4
L5402	TOTM/TRAFFIC CONTROL OPERATIONS	Operating		122
FLEMING,JANET L				
L5402	TOTM/TRAFFIC CONTROL OPERATIONS	Operating		45
L5952	OAID/SNOW	Operating		4

FORD, RAYSHAWN				
L5402	TOTM/TRAFFIC CONTROL OPERATIONS	Operating		78
L5673	Concert for Valor	Operating		12
GODFREY, JASON G				
L5402	TOTM/TRAFFIC CONTROL OPERATIONS	Operating		63
L5673	Concert for Valor	Operating		4
L5680	Fourth of July - 2015	Operating		18
L5952	OAID/SNOW	Operating		92
L5674	Marion Barry's Celebration	Operating		4
GRAHAM, LAQUANT				
L5952	OAID/SNOW	Operating		77
L5402	TOTM/TRAFFIC CONTROL OPERATIONS	Operating		17
GRAVES, JERMONT D				
L5952	OAID/SNOW	Operating		82
L5678	DC Emancipation Day (April 16)	Operating		4
L5677	FY15 Baseball	Operating		4
L5673	Concert for Valor	Operating		12
L5402	TOTM/TRAFFIC CONTROL OPERATIONS	Operating		81
GRAY, YETTA F				
L5674	Marion Barry's Celebration	Operating		19
L5684	POPE FRANCIS VISIT 2015	Operating		11
L5673	Concert for Valor	Operating		2
L5402	TOTM/TRAFFIC CONTROL OPERATIONS	Operating		44
L5680	Fourth of July - 2015	Operating		27
GREEN, ANGELINA L				
L5952	OAID/SNOW	Operating		27
L5402	TOTM/TRAFFIC CONTROL OPERATIONS	Operating		22
L5674	Marion Barry's Celebration	Operating		5
GREEN, CARLA D				
L5674	Marion Barry's Celebration	Operating		20
L5684	POPE FRANCIS VISIT 2015	Operating		10
L5402	TOTM/TRAFFIC CONTROL OPERATIONS	Operating		77
L5952	OAID/SNOW	Operating		73

GREEN,ROBERT A

L5681	Taylor Swift Concert	Operating	9
L5677	FY15 Baseball	Operating	121
L5673	Concert for Valor	Operating	4
L5659	Baseball FY2014	Operating	17
L5402	TOTM/TRAFFIC CONTROL OPERATIONS	Operating	201

HAGGINS JR,ARPELL

L5684	POPE FRANCIS VISIT 2015	Operating	2
L5952	OAID/SNOW	Operating	12
L5673	Concert for Valor	Operating	12
L5402	TOTM/TRAFFIC CONTROL OPERATIONS	Operating	28

HALL,MICHAEL D

L5684	POPE FRANCIS VISIT 2015	Operating	6
L5674	Marion Barry's Celebration	Operating	8
L5402	TOTM/TRAFFIC CONTROL OPERATIONS	Operating	49
L5952	OAID/SNOW	Operating	63
L5673	Concert for Valor	Operating	4

HALSEY,COURTNEY

L5952	OAID/SNOW	Operating	54
-------	-----------	-----------	----

HARGROVE,ROBERT

L5952	OAID/SNOW	Operating	50
L5402	TOTM/TRAFFIC CONTROL OPERATIONS	Operating	31
L5673	Concert for Valor	Operating	12
L5677	FY15 Baseball	Operating	8
L5680	Fourth of July - 2015	Operating	2

HARRIS,MILLICENT

L5952	OAID/SNOW	Operating	43
L5684	POPE FRANCIS VISIT 2015	Operating	10
L5680	Fourth of July - 2015	Operating	12
L5677	FY15 Baseball	Operating	16
L5674	Marion Barry's Celebration	Operating	20
L5402	TOTM/TRAFFIC CONTROL OPERATIONS	Operating	56
L5673	Concert for Valor	Operating	2

HERRIOT,JACK L

L5402	TOTM/TRAFFIC CONTROL OPERATIONS	Operating	100
L5681	Taylor Swift Concert	Operating	10
L5680	Fourth of July - 2015	Operating	12
L5659	Baseball FY2014	Operating	13
L5673	Concert for Valor	Operating	4
L5677	FY15 Baseball	Operating	157

HOOKS,BEVERLY A

L5684	POPE FRANCIS VISIT 2015	Operating	10
L5952	OAID/SNOW	Operating	70
L5674	Marion Barry's Celebration	Operating	19
L5673	Concert for Valor	Operating	2
L5402	TOTM/TRAFFIC CONTROL OPERATIONS	Operating	85

JOHNSON,JENITA

L5402	TOTM/TRAFFIC CONTROL OPERATIONS	Operating	79
L5952	OAID/SNOW	Operating	85
L5684	POPE FRANCIS VISIT 2015	Operating	11
L5677	FY15 Baseball	Operating	6
L5674	Marion Barry's Celebration	Operating	20
L5673	Concert for Valor	Operating	2

JOHNSON,MARQUES

L5402	TOTM/TRAFFIC CONTROL OPERATIONS	Operating	20
L5952	OAID/SNOW	Operating	53

JOHNSON,PAMELA A

L5674	Marion Barry's Celebration	Operating	24
L5677	FY15 Baseball	Operating	14
L5402	TOTM/TRAFFIC CONTROL OPERATIONS	Operating	138
L5680	Fourth of July - 2015	Operating	12
L5684	POPE FRANCIS VISIT 2015	Operating	8
L5952	OAID/SNOW	Operating	92
L5673	Concert for Valor	Operating	2

JONES, TYWAN				
L5674	Marion Barry's Celebration	Operating		19
L5952	OAID/SNOW	Operating		13
L5677	FY15 Baseball	Operating		8
L5402	TOTM/TRAFFIC CONTROL OPERATIONS	Operating		55
L5684	POPE FRANCIS VISIT 2015	Operating		10
KOLLIE, GEORGE S				
L5402	TOTM/TRAFFIC CONTROL OPERATIONS	Operating		8
L5673	Concert for Valor	Operating		4
LANCASTER, ANTHO				
L5402	TOTM/TRAFFIC CONTROL OPERATIONS	Operating		4
LEWIS, JOHN D				
L5952	OAID/SNOW	Operating		37
L5402	TOTM/TRAFFIC CONTROL OPERATIONS	Operating		3
LUCAS, EDWARD				
L5674	Marion Barry's Celebration	Operating		24
L5677	FY15 Baseball	Operating		16
L5952	OAID/SNOW	Operating		59
L5402	TOTM/TRAFFIC CONTROL OPERATIONS	Operating		72
L5673	Concert for Valor	Operating		2
MATTOX JR, ANTHO				
L5674	Marion Barry's Celebration	Operating		24
L5684	POPE FRANCIS VISIT 2015	Operating		10
L5677	FY15 Baseball	Operating		21
L5673	Concert for Valor	Operating		2
L5402	TOTM/TRAFFIC CONTROL OPERATIONS	Operating		65
L5680	Fourth of July - 2015	Operating		15
MCNEIL, TANESHA R				
T4901	8888(400) Audit and Compliance	Direct		106
L5952	OAID/SNOW	Operating		36
MOBLEY, MONIQUE				
L5402	TOTM/TRAFFIC CONTROL OPERATIONS	Operating		4
L5677	FY15 Baseball	Operating		7
L5952	OAID/SNOW	Operating		7
L5684	POPE FRANCIS VISIT 2015	Operating		11

MORTON,DEBORAH				
L5402	TOTM/TRAFFIC CONTROL OPERATIONS	Operating		33
L5952	OAID/SNOW	Operating		41
NICKELSON,CHARL				
L5402	TOTM/TRAFFIC CONTROL OPERATIONS	Operating		52
L5952	OAID/SNOW	Operating		77
L5673	Concert for Valor	Operating		12
PEREZ,NEURIS				
L5673	Concert for Valor	Operating		2
L5674	Marion Barry's Celebration	Operating		12
L5402	TOTM/TRAFFIC CONTROL OPERATIONS	Operating		42
PORTER,GINA				
L5402	TOTM/TRAFFIC CONTROL OPERATIONS	Operating		20
REEDER,DARLENE E				
L5684	POPE FRANCIS VISIT 2015	Operating		10
L5952	OAID/SNOW	Operating		30
L5402	TOTM/TRAFFIC CONTROL OPERATIONS	Operating		150
L5673	Concert for Valor	Operating		2
L5674	Marion Barry's Celebration	Operating		24
L5677	FY15 Baseball	Operating		7
ROA,LUCIA				
L5673	Concert for Valor	Operating		3
L5402	TOTM/TRAFFIC CONTROL OPERATIONS	Operating		40
L5674	Marion Barry's Celebration	Operating		18
L5952	OAID/SNOW	Operating		58
ROBINSON,TIMOTH				
L5680	Fourth of July - 2015	Operating		4
L5952	OAID/SNOW	Operating		36
L5402	TOTM/TRAFFIC CONTROL OPERATIONS	Operating		4
RUSSELL,GAIL H				
L5684	POPE FRANCIS VISIT 2015	Operating		2
L5952	OAID/SNOW	Operating		38
SCHOOLS,AKIA				
L5673	Concert for Valor	Operating		12
L5952	OAID/SNOW	Operating		64

SIMMONS,DE'VONT				
	L5952	OAID/SNOW	Operating	2
SIMPSON,LAJUAN A				
	L5674	Marion Barry's Celebration	Operating	2
	L5402	TOTM/TRAFFIC CONTROL OPERATIONS	Operating	34
SMITH,BIANCA				
	L5952	OAID/SNOW	Operating	121
	L5402	TOTM/TRAFFIC CONTROL OPERATIONS	Operating	40
	L5684	POPE FRANCIS VISIT 2015	Operating	9
	L5673	Concert for Valor	Operating	2
	L5677	FY15 Baseball	Operating	14
STEVE,KEVIN E				
	L5402	TOTM/TRAFFIC CONTROL OPERATIONS	Operating	132
	L5673	Concert for Valor	Operating	12
	L5680	Fourth of July - 2015	Operating	12
	L5677	FY15 Baseball	Operating	55
SUMMERS,CHERYL				
	L5684	POPE FRANCIS VISIT 2015	Operating	10
	L5677	FY15 Baseball	Operating	21
	L5674	Marion Barry's Celebration	Operating	24
	L5673	Concert for Valor	Operating	2
	L5402	TOTM/TRAFFIC CONTROL OPERATIONS	Operating	171
	L5952	OAID/SNOW	Operating	80
TAPP,MERIKA L				
	L5402	TOTM/TRAFFIC CONTROL OPERATIONS	Operating	62
TOLBERT,TASHA				
	L5402	TOTM/TRAFFIC CONTROL OPERATIONS	Operating	3
TYLER,ROLAND VIN				
	L5952	OAID/SNOW	Operating	54
	L5673	Concert for Valor	Operating	12
WALKER,AMEKA L				
	L5402	TOTM/TRAFFIC CONTROL OPERATIONS	Operating	47
	L5684	POPE FRANCIS VISIT 2015	Operating	8
	L5673	Concert for Valor	Operating	2
	L5674	Marion Barry's Celebration	Operating	12

WALKER,GLEN A				
	L5952	OAID/SNOW	Operating	46
	L5677	FY15 Baseball	Operating	2
	L5674	Marion Barry's Celebration	Operating	12
	L5402	TOTM/TRAFFIC CONTROL OPERATIONS	Operating	27
WATKINS,KENDRA				
	L5402	TOTM/TRAFFIC CONTROL OPERATIONS	Operating	2
WATKINS,LORTRICE				
	L5673	Concert for Valor	Operating	12
	L5402	TOTM/TRAFFIC CONTROL OPERATIONS	Operating	83
	L5684	POPE FRANCIS VISIT 2015	Operating	2
	L5680	Fourth of July - 2015	Operating	3
	L5677	FY15 Baseball	Operating	16
WEST,TRACID				
	L5674	Marion Barry's Celebration	Operating	12
	L5952	OAID/SNOW	Operating	14
	L5402	TOTM/TRAFFIC CONTROL OPERATIONS	Operating	19
WILLIAMS,ROMAN				
	L5952	OAID/SNOW	Operating	4
	L5402	TOTM/TRAFFIC CONTROL OPERATIONS	Operating	1
WISE,MICHAEL				
	L5674	Marion Barry's Celebration	Operating	25
	L5684	POPE FRANCIS VISIT 2015	Operating	11
	L5677	FY15 Baseball	Operating	15
	L5402	TOTM/TRAFFIC CONTROL OPERATIONS	Operating	100
	L5952	OAID/SNOW	Operating	83

TOA - Traffic Services Field Operati

Name	Index	TITLE	Type	Total Hours
BAXTER,KIMBERLY				
	L5204	STBM/HEAVY EQUIPMENT OPERATIONS SECTION	Operating	96
	L5010	TSFO- ADMIN SUPPORT	Operating	8
	L5952	OAID/SNOW	Operating	105

DENNIS, IVAH L				
T4984	Street Sign Improvments	Direct		36
T4254	Thermoplastic Pavement Marking	Direct		196
CA512	PAVW-Pavmt Mrking Ward 1-8	Indirect		150
L5952	OAID/SNOW	Operating		105
EVANS, SHAUNTIA M				
L5952	OAID/SNOW	Operating		64
L5673	Concert for Valor	Operating		8
GREENAWAY, LATAS				
T4984	Street Sign Improvments	Direct		9
T4254	Thermoplastic Pavement Marking	Direct		26
CA512	PAVW-Pavmt Mrking Ward 1-8	Indirect		18
L5010	TSFO- ADMIN SUPPORT	Operating		74
L5952	OAID/SNOW	Operating		34
L5POT	Pothole and Pavement Campaign	Operating		50
JONES, ANTHONY L				
T4984	Street Sign Improvments	Direct		108
JONES, JACQUELINE				
L5952	OAID/SNOW	Operating		130
L5684	POPE FRANCIS VISIT 2015	Operating		4
L5005	TSFO/WAREHOUSE SECTION	Operating		30
L5680	Fourth of July - 2015	Operating		12
MURPHY, DANA				
T4254	Thermoplastic Pavement Marking	Direct		272
L5005	TSFO/WAREHOUSE SECTION	Operating		29
L5952	OAID/SNOW	Operating		81
SMITH, CLEMENT EU				
CA510	TSAS - Admin Support	Indirect		12
L5952	OAID/SNOW	Operating		35
STEWART, CHARLES				
T4984	Street Sign Improvments	Direct		58
L5952	OAID/SNOW	Operating		46
WAALDIJK, DAVID S				
T4984	Street Sign Improvments	Direct		84
CA511	SIGW-Sign Inst, Remvl Ward 1-8	Indirect		4
L5952	OAID/SNOW	Operating		93

TOA - Traffic Signal Maintenance Sec

Name	Index	TITLE	Type	Total Hours
DAVIES,JOSEPH B				
	T4561	8888(286)prg. mngt-awi	Direct	1
	CA574	SSIG-Signals	Indirect	12
MCCOY,REGINALD				
	T4547	FY10 Traffic Signal Construction	Direct	24
	T4918	1102(030) K St ADA Improvement	Direct	36
	L5680	Fourth of July - 2015	Operating	12
MCINTOSH,MICHAEL				
	L5952	OAID/SNOW	Operating	92
	L5680	Fourth of July - 2015	Operating	12
	L595T	Snow Training	Operating	4
MOORE,JOSEPH W				
	L5680	Fourth of July - 2015	Operating	12
ROA,LUIS ERNESTO				
	T4324	8888(360)Traffic Signal Optim	Direct	12
	T4909	ITS INTEGRATION DEV	Direct	9
WIGGINS,VALORIE E				
	T4984	Street Sign Improvments	Direct	8
	T4254	Thermoplastic Pavement Marking	Direct	47
	CA516	FAVR-Sign Fabrication	Indirect	50
	CA511	SIGW-Sign Inst, Remvl Ward 1-8	Indirect	16
	CA512	PAVW-Pavmt Mrking Ward 1-8	Indirect	8
	L5952	OAID/SNOW	Operating	12

TOA - Traffic Signal Section

Name	Index	TITLE	Type	Total Hours
BAILEY,BRENDA L				
	L5952	OAID/SNOW	Operating	51
	L5202	STBM/ROADWAY MAINTENANCE SECTION	Operating	34

TOA - Transportation Management Cent

Name	Index	TITLE	Type	Total Hours
AKOPIAN,EDWARD				
	T4907	TMC OPS / SPEC EVENTS	Direct	60
	CA530	Traffic Management Center	Indirect	18

BAILEY,LESLIE M				
L5402	TOTM/TRAFFIC CONTROL OPERATIONS	Operating		25
BARKSDALE,CARLO				
T4908	ROADWAY OP PATROL	Direct		64
T4805	Streetlight Asset Mgmt	Direct		16
L5673	Concert for Valor	Operating		4
L5683	Citi Open Tennis Classic	Operating		8
L5684	POPE FRANCIS VISIT 2015	Operating		8
BROWN,VICTOR C				
T4908	ROADWAY OP PATROL	Direct		109
CHAUDHRY,ZAHID				
L5673	Concert for Valor	Operating		4
L5680	Fourth of July - 2015	Operating		12
GREEN,NILLEA D				
T4907	TMC OPS / SPEC EVENTS	Direct		37
CA530	Traffic Management Center	Indirect		11
JAMES,KEVIN L				
T4805	Streetlight Asset Mgmt	Direct		5
T4908	ROADWAY OP PATROL	Direct		64
CA520	Roadway Operations Unit	Indirect		26
L5673	Concert for Valor	Operating		4
LEWIS,MALCOLM A				
CA520	Roadway Operations Unit	Indirect		14
MCPHAUL JENKINS,				
T4907	TMC OPS / SPEC EVENTS	Direct		4
L5402	TOTM/TRAFFIC CONTROL OPERATIONS	Operating		8
OUTING,RAYTESHE				
T4907	TMC OPS / SPEC EVENTS	Direct		95
CA530	Traffic Management Center	Indirect		6
L5680	Fourth of July - 2015	Operating		12
PREE,MELONY A				
CA524	Street & Bridge Admin	Indirect		55
L5952	OAID/SNOW	Operating		124
L5201	TSFO/RODWAY REPAIR SECTION	Operating		118
L595T	Snow Training	Operating		12
L5ALY	Rally for the Alley	Operating		22

ROSCOE,PHYLLIS Y				
	CA530	Traffic Management Center	Indirect	2
TURNER,BENJAMIN				
	T4907	TMC OPS / SPEC EVENTS	Direct	4
	CA530	Traffic Management Center	Indirect	16
WADDY,LEON E				
	CA530	Traffic Management Center	Indirect	12
WARE JR,LAWRENC				
	L5402	TOTM/TRAFFIC CONTROL OPERATIONS	Operating	67
	L5684	POPE FRANCIS VISIT 2015	Operating	8
WILLIAMS,ALGERNO				
	T4907	TMC OPS / SPEC EVENTS	Direct	4
	L5402	TOTM/TRAFFIC CONTROL OPERATIONS	Operating	8
WINFIELD,VANESSA				
	L1090	PERFORMANCE MANAGEMENT	Operating	7
WOOTEN,NICOLE M				
	T4907	TMC OPS / SPEC EVENTS	Direct	24
	CA530	Traffic Management Center	Indirect	2

TOA - Transportation Operations Divi

Name	Index	TITLE	Type	Total Hours
ABOUSAEEDI,MAKA				
	L5673	Concert for Valor	Operating	3
	L5951	OAID/ADMIN SUPPORT	Operating	8
	L5684	POPE FRANCIS VISIT 2015	Operating	4
	L5680	Fourth of July - 2015	Operating	12
HALL,MONROE D				
	T4547	FY10 Traffic Signal Construction	Direct	12
	CA513	TRSS-Traffic Signal Section	Indirect	12
	L5952	OAID/SNOW	Operating	71
	L595T	Snow Training	Operating	4
PATRICK,EUGENE P				
	CA513	TRSS-Traffic Signal Section	Indirect	8

TOA - Transportation Services Team (

Name	Index	TITLE	Type	Total Hours
NWABUEZE,VICTOR				
	L7021	DEPARTMENT OF TRANSPORTATION	Operating	99

SARTIN,LANEL

CA582	INSP-Inspection & Investigation	Indirect	247
L5ALY	Rally for the Alley	Operating	3
L5952	OAID/SNOW	Operating	139

TOA - Ward 1 & 2

Name	Index	TITLE	Type	Total Hours
GAINES,JOHN F				
	CA521	RMAS-Roadway Maint Section	Indirect	68
	L5952	OAID/SNOW	Operating	115
	L5POT	Pothole and Pavement Campaign	Operating	64
	L5680	Fourth of July - 2015	Operating	12
	L5684	POPE FRANCIS VISIT 2015	Operating	18

WILLIAMS,JEFFREY

CA521	RMAS-Roadway Maint Section	Indirect	121
L5952	OAID/SNOW	Operating	124
L595T	Snow Training	Operating	4
L5684	POPE FRANCIS VISIT 2015	Operating	18
L5POT	Pothole and Pavement Campaign	Operating	118

TOA - Ward 3 & 4

Name	Index	TITLE	Type	Total Hours
GARNETT,EARL				
	K0161	Street and Alley Maint & Repair	Direct	13
	CA521	RMAS-Roadway Maint Section	Indirect	68
	L5952	OAID/SNOW	Operating	69
	L5POT	Pothole and Pavement Campaign	Operating	200

JOHNSON,CLIFTON

CA522	RRES-Roadway Repair Section	Indirect	80
CA521	RMAS-Roadway Maint Section	Indirect	2
L5952	OAID/SNOW	Operating	86
L5POT	Pothole and Pavement Campaign	Operating	56

LAKE,OSBORNE

CA521	RMAS-Roadway Maint Section	Indirect	223
L5202	STBM/ROADWAY MAINTENANCE SECTION	Operating	8
L5684	POPE FRANCIS VISIT 2015	Operating	8
L5952	OAID/SNOW	Operating	143
L595T	Snow Training	Operating	8
L5POT	Pothole and Pavement Campaign	Operating	142
L5659	Baseball FY2014	Operating	4

MILLER,RONALD R

L5202	STBM/ROADWAY MAINTENANCE SECTION	Operating	132
L5684	POPE FRANCIS VISIT 2015	Operating	4
L5952	OAID/SNOW	Operating	116
L595T	Snow Training	Operating	10
L5POT	Pothole and Pavement Campaign	Operating	17

PARKER,JOSEPH J

L5POT	Pothole and Pavement Campaign	Operating	28
L5204	STBM/HEAVY EQUIPMENT OPERATIONS SECTION	Operating	35
L5952	OAID/SNOW	Operating	50
L595T	Snow Training	Operating	4

TAQEE,HASAN NAJ

CA521	RMAS-Roadway Maint Section	Indirect	156
L5952	OAID/SNOW	Operating	69
L5659	Baseball FY2014	Operating	12
L5684	POPE FRANCIS VISIT 2015	Operating	12
L5POT	Pothole and Pavement Campaign	Operating	223
L595T	Snow Training	Operating	4

WOOTEN,GEORGE A

CA522	RRES-Roadway Repair Section	Indirect	128
L595T	Snow Training	Operating	4
L5201	TSFO/RODWAY REPAIR SECTION	Operating	26
L5952	OAID/SNOW	Operating	115
L5POT	Pothole and Pavement Campaign	Operating	86

YOUNG,DOUGLAS

CA521	RMAS-Roadway Maint Section	Indirect	147
L5952	OAID/SNOW	Operating	131
L5POT	Pothole and Pavement Campaign	Operating	152
L5680	Fourth of July - 2015	Operating	12
L5676	State of the Union FY2015	Operating	4

TOA - Ward 5 & 6

Name	Index	TITLE	Type	Total Hours
BROWN,DERRICK E				
	L5202	STBM/ROADWAY MAINTENANCE SECTION	Operating	2
BUTLER,MARQUES				
	L5680	Fourth of July - 2015	Operating	12
	L5952	OAID/SNOW	Operating	96
	L5659	Baseball FY2014	Operating	12
	L5POT	Pothole and Pavement Campaign	Operating	130
	L5673	Concert for Valor	Operating	4
	L5204	STBM/HEAVY EQUIPMENT OPERATIONS SECTION	Operating	218
GAMBLE,TERRENCE				
	L595T	Snow Training	Operating	8
	L5952	OAID/SNOW	Operating	67
	L5204	STBM/HEAVY EQUIPMENT OPERATIONS SECTION	Operating	198
	L5POT	Pothole and Pavement Campaign	Operating	224
LOVE,EUGENE				
	L595T	Snow Training	Operating	4
	L5POT	Pothole and Pavement Campaign	Operating	8
	L5952	OAID/SNOW	Operating	92
	L5684	POPE FRANCIS VISIT 2015	Operating	8
	L5202	STBM/ROADWAY MAINTENANCE SECTION	Operating	96
ROBINSON,JUSTIN				
	L5684	POPE FRANCIS VISIT 2015	Operating	18
	L5POT	Pothole and Pavement Campaign	Operating	112
	L595T	Snow Training	Operating	4
	L5202	STBM/ROADWAY MAINTENANCE SECTION	Operating	49
	L5952	OAID/SNOW	Operating	110

TINNER,PAULETTE E

CA521	RMAS-Roadway Maint Section	Indirect	146
L5POT	Pothole and Pavement Campaign	Operating	174
L5ALY	Rally for the Alley	Operating	4
L5952	OAID/SNOW	Operating	114

WEEMS,ANITRA T

K0161	Street and Alley Maint & Repair	Direct	9
CA521	RMAS-Roadway Maint Section	Indirect	159
L5952	OAID/SNOW	Operating	143
L5684	POPE FRANCIS VISIT 2015	Operating	18
L5POT	Pothole and Pavement Campaign	Operating	170

WHREN,JAMES A

CA521	RMAS-Roadway Maint Section	Indirect	12
L5ALY	Rally for the Alley	Operating	3
L5952	OAID/SNOW	Operating	69
L5684	POPE FRANCIS VISIT 2015	Operating	4

TOA - Ward 7 & 8

Name	Index	TITLE	Type	Total Hours
JOHNSON,BRENDA				
	L5952	OAID/SNOW	Operating	65
	L5POT	Pothole and Pavement Campaign	Operating	70
	L5680	Fourth of July - 2015	Operating	12
JONES,DERRICK A				
	CA521	RMAS-Roadway Maint Section	Indirect	25
	L5POT	Pothole and Pavement Campaign	Operating	20
	L5952	OAID/SNOW	Operating	47
MIMS,MICHAEL R				
	CA521	RMAS-Roadway Maint Section	Indirect	86
	L5POT	Pothole and Pavement Campaign	Operating	94
	L5952	OAID/SNOW	Operating	68
OWENS,ANTHONY				
	CA521	RMAS-Roadway Maint Section	Indirect	66
	L5POT	Pothole and Pavement Campaign	Operating	40
	L595T	Snow Training	Operating	4
	L5952	OAID/SNOW	Operating	93

SHORT, RICARDO O

CA521	RMAS-Roadway Maint Section	Indirect	179
L5POT	Pothole and Pavement Campaign	Operating	152
L5952	OAID/SNOW	Operating	65

TOA - Wards 7 & 8

Name	Index	TITLE	Type	Total Hours
WALKER, ROBERT D				
	T4254	Thermoplastic Pavement Marking	Direct	258
	L5952	OAID/SNOW	Operating	40
	L5802	SIOD/INSPECTIONS AND INVESTIGATIONS	Operating	188

UFA - Field Operations Division

Name	Index	TITLE	Type	Total Hours
CAMPBELL, NATHAN				
	K0164	Integrated Pest Management	Direct	44
	L5952	OAID/SNOW	Operating	44
DARDEN, JERRY L				
	K0164	Integrated Pest Management	Direct	14
	L5952	OAID/SNOW	Operating	79
	L5POT	Pothole and Pavement Campaign	Operating	54
DORSEY, ROBERT				
	K0164	Integrated Pest Management	Direct	8
	L5952	OAID/SNOW	Operating	0
JOHNSON, JAMES O				
	K0164	Integrated Pest Management	Direct	67
	L5952	OAID/SNOW	Operating	63
LEIVA, ISAIAS				
	L5952	OAID/SNOW	Operating	63
LINDSAY, LASHAWN				
	K0164	Integrated Pest Management	Direct	15
	L5POT	Pothole and Pavement Campaign	Operating	44
	L5952	OAID/SNOW	Operating	57
MCKIM, SHAUN L				
	T4788	TREE PLANTING	Direct	14
MILLER, JANET LEE				
	K0164	Integrated Pest Management	Direct	17
	T4788	TREE PLANTING	Direct	24

PHILLIPS,JIMMY O

K0164	Integrated Pest Management	Direct	9
L5952	OAID/SNOW	Operating	37

WHALEN JR,DONAL

K0164	Integrated Pest Management	Direct	1
L5952	OAID/SNOW	Operating	53

UFA - Program Operations Divisions

Name	Index	TITLE	Type	Total Hours
BABRA,RANJIT S				
	63970	DEPARTMENT OF TRANSPORTATION	Indirect	90
BANUA,SIMOUN				
	T4788	TREE PLANTING	Direct	6
	K0164	Integrated Pest Management	Direct	14
BURCKLE,JOSEPH H				
	K0164	Integrated Pest Management	Direct	12
	63970	DEPARTMENT OF TRANSPORTATION	Indirect	11
CHAPMAN,JACK A				
	K0164	Integrated Pest Management	Direct	18
CHUKO,MICHAEL S				
	K0164	Integrated Pest Management	Direct	4
CONLON,JOEL P				
	K0164	Integrated Pest Management	Direct	48
	T4788	TREE PLANTING	Direct	52
	T4871	Tree Asset Maintenance	Direct	24
CORLETTA,ROBERT				
	T4788	TREE PLANTING	Direct	3
	63970	DEPARTMENT OF TRANSPORTATION	Indirect	34
ERTEM,MUNEVVER				
	T4788	TREE PLANTING	Direct	10
	K0164	Integrated Pest Management	Direct	10
	63970	DEPARTMENT OF TRANSPORTATION	Indirect	1
HEIST,WILLIAM L				
	T4788	TREE PLANTING	Direct	5
KLAPTHOR,CARLSO				
	T4788	TREE PLANTING	Direct	4
	K0164	Integrated Pest Management	Direct	14

MAEHR,ERIN				
	T4788	TREE PLANTING	Direct	8
MCCULLY,ROBERT				
	T4788	TREE PLANTING	Direct	4
	63970	DEPARTMENT OF TRANSPORTATION	Indirect	167
MCKINDLEY-WARD,				
	K0164	Integrated Pest Management	Direct	4
	T4788	TREE PLANTING	Direct	4
	63970	DEPARTMENT OF TRANSPORTATION	Indirect	5
POND III,JOHN A				
	T4788	TREE PLANTING	Direct	8
	K0164	Integrated Pest Management	Direct	16
	63970	DEPARTMENT OF TRANSPORTATION	Indirect	12
UFA - UFA				
Name	Index	TITLE	Type	Total Hours
DUNCAN,LENNITA				
	63970	DEPARTMENT OF TRANSPORTATION	Indirect	3
EUTSLER,EARL C				
	63970	DEPARTMENT OF TRANSPORTATION	Indirect	70
O'NEILL,JOHN				
	K0164	Integrated Pest Management	Direct	8
	T4788	TREE PLANTING	Direct	2
	63970	DEPARTMENT OF TRANSPORTATION	Indirect	34
YTURRALDE,KASEY				
	K0164	Integrated Pest Management	Direct	16
	T4788	TREE PLANTING	Direct	14

Breakdown of FY16 DDOT Employee Overtime Charges Through 1/23/16

IPMA - Anacostia Waterfront Initiativ				
Name	Index	TITLE	Type	Total Hours
ASFAW,ETAYENESH				
	K0503	Stormwater Project	Direct	9
CLOYD,RA'ADIA K				
	L595T	Snow Training	Operating	3
	L5952	OAID/SNOW	Operating	12
D'ARBELA,DENIS				
	L5952	OAID/SNOW	Operating	18
DORSEY,JOSEPH D				
	T4561	8888(286)prg. mngt-awi	Direct	4
	T4613	NH-1501(37)SCap St EIS	Direct	38
	L5952	OAID/SNOW	Operating	30
	L595T	Snow Training	Operating	6
JOHNSON,DAMON S				
	T4561	8888(286)prg. mngt-awi	Direct	31
	T4085	StreetCars	Direct	2
	CA582	INSP-Inspection & Investigation	Indirect	46
OKECHUKWU,ALEX				
	L595T	Snow Training	Operating	2
	L5952	OAID/SNOW	Operating	12
OLADOKUN,ABIODU				
	K0520	RALLY FOR ALLYS (ALLY PALOOZA)	Direct	142
	22770	DEPARTMENT OF TRANSPORTATION	Indirect	2
SIMIE,EJIGINEH				
	T4561	8888(286)prg. mngt-awi	Direct	10
IPMA - Asset Management				
Name	Index	TITLE	Type	Total Hours
AZZAM,AMAL E				
	L5952	OAID/SNOW	Operating	15

IPMA - Asset Management Analysis Divi

Name	Index	TITLE	Type	Total Hours
CARPENTER,EDWAR	L5952	OAID/SNOW	Operating	18
HORTON JR,ROBERT	T4658	STP-8888(374)FY11 FA PR	Direct	40
MAKONNEN,WOLDE	T2888	Local Restr, resurf, upgr- W5	Direct	14
MATHARU,JASWAN	K0062	FA13 FA Pavement Restoration, NHS	Direct	117
	L5952	OAID/SNOW	Operating	20
MOON,ADRIAN S	T3909	FY08 CAPITAL PROJ PROFILE ESTABLISHMENT	Direct	161
	L595T	Snow Training	Operating	3
	L5952	OAID/SNOW	Operating	38
RENNIE,SIMON A	T4948	NH-8888(415) Asset Mnt Tunnels	Direct	42
	L595T	Snow Training	Operating	6
	L5952	OAID/SNOW	Operating	12
TESFAYE,YARED	L5952	OAID/SNOW	Operating	18
TOYER,DELANTE T	K0520	RALLY FOR ALLYS (ALLY PALOOZA)	Direct	103
	T4658	STP-8888(374)FY11 FA PR	Direct	32
	L5952	OAID/SNOW	Operating	24

IPMA - Field Operations/Research Sect

Name	Index	TITLE	Type	Total Hours
LADIPOH,ALBERT	L5952	OAID/SNOW	Operating	7
MANGA,ETA-MANYI	L5952	OAID/SNOW	Operating	12
PATEL,BIPINBHAI R	MTL13	Material Testing	Indirect-MTEST	32
	L5952	OAID/SNOW	Operating	22
	L595T	Snow Training	Operating	3

IPMA - IPMA

Name	Index	TITLE	Type	Total Hours
BEMBRY,JESSICA I				
	22770	DEPARTMENT OF TRANSPORTATION	Indirect	50
BROGDEN,TROY				
	L5952	OAID/SNOW	Operating	20
CHEBLI,OTHMAN				
	L2003	RIGHTS OF WAY	Operating	12
	L595T	Snow Training	Operating	0
DICKERSON,CLARE				
	L595T	Snow Training	Operating	2
	L5952	OAID/SNOW	Operating	12
DUEL,JOHN				
	L595T	Snow Training	Operating	4
	L5952	OAID/SNOW	Operating	21
EL-HAMRI,JAMEL				
	L595T	Snow Training	Operating	1
PAUL,ALBERTA L				
	L2002	PROJECT DEVELOPMENT AND MANAGEMENT	Operating	57
	L5952	OAID/SNOW	Operating	12
ROBINSON,ELIJAH				
	T4658	STP-8888(374)FY11 FA PR	Direct	8
	T4085	StreetCars	Direct	4
	K0062	FA13 FA Pavement Restoration, NHS	Direct	34
	L5952	OAID/SNOW	Operating	6
	L3OVT	StreetCar - Overtime	Operating	16
UDEH,MADUABUCH				
	K0062	FA13 FA Pavement Restoration, NHS	Direct	8
	K0520	RALLY FOR ALLYS (ALLY PALOOZA)	Direct	92
	L5952	OAID/SNOW	Operating	4

IPMA - Local Roadway Projects

Name	Index	TITLE	Type	Total Hours
JAMABO,DEINMA A				
	K0348	GA Ave,NW Dedicated Bus Lane	Direct	169
	L5952	OAID/SNOW	Operating	12

K0328	Resurf 7th St,NW N-FL Ave	Direct	2
-------	---------------------------	--------	---

IPMA - Materials Laboratory

Name	Index	TITLE	Type	Total Hours
SCHNEIDER,MICHAEL				
	MTL13	Material Testing	Indirect-MTEST	8

IPMA - Safety Standards and Quality C

Name	Index	TITLE	Type	Total Hours
KEST,DANIEL J				
	22770	DEPARTMENT OF TRANSPORTATION	Indirect	6
	MTL13	Material Testing	Indirect-MTEST	10
	L595T	Snow Training	Operating	3
KRETSI,CHARLES K				
	T4658	STP-8888(374)FY11 FA PR	Direct	16
	K0226	Anacostia Reg. Trail - TIGER	Direct	26
	MTL13	Material Testing	Indirect-MTEST	17
	L595T	Snow Training	Operating	3
	L5952	OAID/SNOW	Operating	24
LEDDA,PATRICK G				
	K0348	GA Ave,NW Dedicated Bus Lane	Direct	4
	K0062	FA13 FA Pavement Restoration, NHS	Direct	12
MEDHANI,REZENE G				
	MTL13	Material Testing	Indirect-MTEST	8
NABU,DANIEL				
	MTL13	Material Testing	Indirect-MTEST	16
NUR,ELMI ALI				
	K0062	FA13 FA Pavement Restoration, NHS	Direct	8
PHILLIP,CARLOS D				
	K0342	27th St,NW ov Broad Branch Str	Direct	8
SPICER,LAKIERA				
	L2001	PREVENTIVE & ROUTINE ROADWAY MAINTENENCE	Operating	36

IPMA - Storm Water Management Branch

Name	Index	TITLE	Type	Total Hours
NUNEZ,DANILO				
	T4263	Intra District - MOU	Direct	2
	K0272	KLINGLE WATERSHED	Direct	3

UPCHURCH,MEREDI

K0503 Stormwater Project Direct 55

IPMA - Team 1

Name	Index	TITLE	Type	Total Hours
AGAHI,GHOLAM A				
	22770	DEPARTMENT OF TRANSPORTATION	Indirect	3
AYODELE,SAMUEL				
	22770	DEPARTMENT OF TRANSPORTATION	Indirect	2
BROWN,TARIFA M				
	L5952	OAID/SNOW	Operating	25
HACKNEY,JEROME				
	22770	DEPARTMENT OF TRANSPORTATION	Indirect	16
PRINCE,MAURICE				
	T2888	Local Restr, resurf, upgr- W5	Direct	109
	22770	DEPARTMENT OF TRANSPORTATION	Indirect	56
SARABI,AIDIN REZA				
	K0213	REHAB OF 1ST ST NE	Direct	8

IPMA - Team 2

Name	Index	TITLE	Type	Total Hours
ADEYEMO,BABATU				
	L5952	OAID/SNOW	Operating	24
AKINBOLAJO,FREDE				
	T4805	Streetlight Asset Mgmt	Direct	5
BOZKURT,DIYAR				
	L5952	OAID/SNOW	Operating	15
	L595T	Snow Training	Operating	3
DORRIZ,ZAHRA				
	K0381	Klinge Valley Trail	Direct	5
	T3007	NRT-2003(005)ROCK CREEK TRAIL IMPRVS	Direct	6
	L5952	OAID/SNOW	Operating	12
FREEMAN,STANLEY				
	T3939	Rehab 16th St over Military	Direct	80
	K0342	27th St,NW ov Broad Branch Str	Direct	10
HILL JR,OBRIENT				
	CA582	INSP-Inspection & Investigation	Indirect	45
	L595T	Snow Training	Operating	4

HYLTON,MODIBO K				
	K0520	RALLY FOR ALLYS (ALLY PALOOZA)	Direct	218
	L595T	Snow Training	Operating	3
	L5952	OAID/SNOW	Operating	30
KAUFMANN,ANDRE				
	T3939	Rehab 16th St over Military	Direct	3
	K0381	Klingle Valley Trail	Direct	5
	T4952	Blair Rd/Cedar St/4th St, NW	Direct	2
	K0342	27th St,NW ov Broad Branch Str	Direct	2
	L595T	Snow Training	Operating	3
	L5952	OAID/SNOW	Operating	22
KEBEDE,DAWIT W				
	K0425	FY15 Ward 8 StreetScapes	Direct	4
	L595T	Snow Training	Operating	3
	L5952	OAID/SNOW	Operating	14
LESTER,WILLIAM				
	K0520	RALLY FOR ALLYS (ALLY PALOOZA)	Direct	168
	K0381	Klingle Valley Trail	Direct	8
MARSHALL,GREGOR				
	T4948	NH-8888(415) Asset Mnt Tunnels	Direct	31
	L5952	OAID/SNOW	Operating	12
MONTENEGRO,FRA				
	K0381	Klingle Valley Trail	Direct	38
	T3941	Rehab 16th st over Military	Direct	19
	K0342	27th St,NW ov Broad Branch Str	Direct	22
OGBEIDE,PATRICK O				
	22770	DEPARTMENT OF TRANSPORTATION	Indirect	18
OHLSON PE,KYLE N				
	L595T	Snow Training	Operating	2
STRANGE,ALFRED T				
	T2904	FY03 LOCAL RECONST/RESURF/UPGRD WARD 6	Direct	12
	L595T	Snow Training	Operating	3
TICKLE,VRUSHALI				
	22770	DEPARTMENT OF TRANSPORTATION	Indirect	5

IPMA - Team 3

Name	Index	TITLE	Type	Total Hours
------	-------	-------	------	-------------

ANANTH,SRINATH				
	K0520	RALLY FOR ALLYS (ALLY PALOOZA)	Direct	79
	L5952	OAID/SNOW	Operating	18
GANA,MATTHEW K				
	K0470	Capital Crossing Development	Direct	64
NJEPU,ROMANUS				
	K0520	RALLY FOR ALLYS (ALLY PALOOZA)	Direct	119
	22770	DEPARTMENT OF TRANSPORTATION	Indirect	20
NORMAN,GAIL O				
	K0520	RALLY FOR ALLYS (ALLY PALOOZA)	Direct	33
SHEFFIELD JR,EDMO				
	K0470	Capital Crossing Development	Direct	4
	L5952	OAID/SNOW	Operating	12

IPMA - Team 4

Name	Index	TITLE	Type	Total Hours
IGHO-OSAGIE,OLABI				
	K0332	49TH ST NE TRAFFIC CALM PROJ	Direct	3
	L595T	Snow Training	Operating	2
JACKSON,ANTHONY				
	T4956	FY12 Guiderail and Attenuators	Direct	2
	L5952	OAID/SNOW	Operating	24
KIM,HUNTAE				
	L595T	Snow Training	Operating	3
OLATUNJI,SAMUEL				
	L5952	OAID/SNOW	Operating	12
	L595T	Snow Training	Operating	3
SIRAGA,BRUK G				
	T4561	8888(286)prg. mngt-awi	Direct	130
	L5952	OAID/SNOW	Operating	8
	L595T	Snow Training	Operating	3
UMEZURIKE,CHARL				
	K0147	Revitalization MN Ave. Phase I	Direct	64
	22770	DEPARTMENT OF TRANSPORTATION	Indirect	20

Not in current Schedule A - Not in current Schedule A

Name	Index	TITLE	Type	Total Hours
------	-------	-------	------	-------------

DONALDSON,DAVID

L5402	TOTM/TRAFFIC CONTROL OPERATIONS	Operating	19
L5952	OAID/SNOW	Operating	8

PERRY,DERRICK D

L7100	DEPARTMENT OF TRANSPORTATION	Operating	178
L5952	OAID/SNOW	Operating	14

Office of the Director - Administrative Services Branch

Name	Index	TITLE	Type	Total Hours
AMPEDU,ERIC OSEI	L5952	OAID/SNOW	Operating	20
DIXON,SYLVESTER J	L5952	OAID/SNOW	Operating	16
FLOWERS,RAMONO	L5952	OAID/SNOW	Operating	16
LUTANGU,NDUMBA	L5952	OAID/SNOW	Operating	15
PATTERSON,SHARO	L5952	OAID/SNOW	Operating	16
POWELL,TANYA	L5952	OAID/SNOW	Operating	31
SMITH-MATHIS,LED	L595T	Snow Training	Operating	3
	L1010	PERSONNEL	Operating	13
WALKER,CHARNITA	L5952	OAID/SNOW	Operating	12

Office of the Director - Civil Rights

Name	Index	TITLE	Type	Total Hours
KABIR,MOHAMMED	L5952	OAID/SNOW	Operating	9

Office of the Director - Communications

Name	Index	TITLE	Type	Total Hours
PHIPPS EVANS,MICH	PAYRL	DEFAULT PAYROLL INDEX	Indirect	7
	L1080	COMMUNICATIONS	Operating	6
	L5952	OAID/SNOW	Operating	16

SUTTON,RODNEY

L1080 COMMUNICATIONS Operating 4

Office of the Director - Customer Service Call Center

Name	Index	TITLE	Type	Total Hours
HOLLIWAY,LONDON				
	L5952	OAID/SNOW	Operating	12
NOBLES,AARON				
	L5952	OAID/SNOW	Operating	19
	L3OVT	StreetCar - Overtime	Operating	6

Office of the Director - Customer Service Clearinghouse

Name	Index	TITLE	Type	Total Hours
DOLBERRY,DELESIA				
	T4658	STP-8888(374)FY11 FA PR	Direct	9
	L1085	CUSTOMER SERVICE	Operating	4
	L5952	OAID/SNOW	Operating	21
WARE,AMANDA H				
	L5952	OAID/SNOW	Operating	12

Office of the Director - Facilities Management

Name	Index	TITLE	Type	Total Hours
DANIEL,PHILLIP				
	L5952	OAID/SNOW	Operating	12
	L5204	STBM/HEAVY EQUIPMENT OPERATIONS SECTION	Operating	18
FREEMAN,ROBYN				
	L5952	OAID/SNOW	Operating	16
GRANBERRY,GREGO				
	CA524	Street & Bridge Admin	Indirect	8
	L5952	OAID/SNOW	Operating	12
	L1030	PROPERTY MANAGEMENT	Operating	25
HAWKINS,RALPH				
	L5952	OAID/SNOW	Operating	16
JOHNSON JR,HUBER				
	L5952	OAID/SNOW	Operating	18
	L1030	PROPERTY MANAGEMENT	Operating	39
LOWE,CALVIN				
	L1030	PROPERTY MANAGEMENT	Operating	6

SIMMONS,GREGORY

CA524	Street & Bridge Admin	Indirect	4
L595T	Snow Training	Operating	3
L1030	PROPERTY MANAGEMENT	Operating	81

Office of the Director - Human Capital Management

Name	Index	TITLE	Type	Total Hours
-------------	--------------	--------------	-------------	--------------------

HIGGINS,KENNETH

L5952	OAID/SNOW	Operating	2
-------	-----------	-----------	---

MESSAM,STEVEN E

L1010	PERSONNEL	Operating	4
L5952	OAID/SNOW	Operating	23

WINZOR,MALIKA

L5952	OAID/SNOW	Operating	19
-------	-----------	-----------	----

Office of the Director - OFFICE OF DIRECTOR

Name	Index	TITLE	Type	Total Hours
-------------	--------------	--------------	-------------	--------------------

RHONES,AARON R

L5952	OAID/SNOW	Operating	12
-------	-----------	-----------	----

Office of the Director - Office of Emergency Preparedness

Name	Index	TITLE	Type	Total Hours
-------------	--------------	--------------	-------------	--------------------

CARSON,ANTHONY

L5952	OAID/SNOW	Operating	12
-------	-----------	-----------	----

JONES,NATALIE E

L5688	March for Life Rally - Jan 22	Operating	20
-------	-------------------------------	-----------	----

WARD,BETTYE JEAN

L5688	March for Life Rally - Jan 22	Operating	4
L5685	"Justice or Else!" Million Man	Operating	10

Office of the Director - Office of the Director Support

Name	Index	TITLE	Type	Total Hours
-------------	--------------	--------------	-------------	--------------------

BANKS,FELICIA L

L5952	OAID/SNOW	Operating	36
-------	-----------	-----------	----

COLEMAN,THOMAS

L1010	PERSONNEL	Operating	8
L3OVT	StreetCar - Overtime	Operating	1

Office of the Director - Training

Name	Index	TITLE	Type	Total Hours
-------------	--------------	--------------	-------------	--------------------

ALSTON,CHARLOTT

L595T	Snow Training	Operating	10
L5952	OAID/SNOW	Operating	19

FORGY,NICHOLE L

K0520	RALLY FOR ALLYS (ALLY PALOOZA)	Direct	5
T4658	STP-8888(374)FY11 FA PR	Direct	16
L5952	OAID/SNOW	Operating	20

SPENCER,TARITA

L5952	OAID/SNOW	Operating	12
-------	-----------	-----------	----

OITI - Applications & Development Supp

Name	Index	TITLE	Type	Total Hours
-------------	--------------	--------------	-------------	--------------------

NIMMAGADDA,RAM

L1040	INFORMATION TECHNOLOGY	Operating	8
L5952	OAID/SNOW	Operating	12

SHIVADHANAM,LEE

L5952	OAID/SNOW	Operating	13
L5688	March for Life Rally - Jan 22	Operating	3

OITI - DDOT IT Program Managers

Name	Index	TITLE	Type	Total Hours
-------------	--------------	--------------	-------------	--------------------

ANYANWU,ISDORE

L1040	INFORMATION TECHNOLOGY	Operating	13
L5952	OAID/SNOW	Operating	12

OITI - Geospatial Data Systems Division

Name	Index	TITLE	Type	Total Hours
-------------	--------------	--------------	-------------	--------------------

JONES,JON

L5952	OAID/SNOW	Operating	12
-------	-----------	-----------	----

KARVEE,WASHINGT

L5952	OAID/SNOW	Operating	24
-------	-----------	-----------	----

OITI - Information Technology OITI

Name	Index	TITLE	Type	Total Hours
-------------	--------------	--------------	-------------	--------------------

LAMONT,ELIZABET

L595T	Snow Training	Operating	16
L1040	INFORMATION TECHNOLOGY	Operating	40
L5685	"Justice or Else!" Million Man	Operating	8

TOATLEY,RUMON

L5952	OAID/SNOW	Operating	18
-------	-----------	-----------	----

WILSON,JONATHAN

L5952	OAID/SNOW	Operating	18
L3OVT	StreetCar - Overtime	Operating	16
L1040	INFORMATION TECHNOLOGY	Operating	88
L5688	March for Life Rally - Jan 22	Operating	4

OITI - Infrastructure & Customer Supp

Name	Index	TITLE	Type	Total Hours
ALI,RASHEED I	L5952	OAID/SNOW	Operating	12
DIXON,MARLENE P	L5952	OAID/SNOW	Operating	26
FAUST,CHRISTOPHE	L5952	OAID/SNOW	Operating	12
FISH,TURNESHA J	L5952	OAID/SNOW	Operating	18
HILL,GREER	L1090	PERFORMANCE MANAGEMENT	Operating	6
HIRED,KHALIF	L5952	OAID/SNOW	Operating	16
KHAN,FAISAL A	L5952	OAID/SNOW	Operating	12
	L1040	INFORMATION TECHNOLOGY	Operating	2
SAID,MOHAMED M	L5952	OAID/SNOW	Operating	12
	L1040	INFORMATION TECHNOLOGY	Operating	12

PPSA - Highway Safety, Research & Tec

Name	Index	TITLE	Type	Total Hours
GAY,KAREN M	L4005	PERMIT	Operating	7
	L5952	OAID/SNOW	Operating	21

PPSA - Plan Review & Compliance Divis

Name	Index	TITLE	Type	Total Hours
FIELDS,DELOIS D	L5952	OAID/SNOW	Operating	12

PPSA - Policy Branch

Name	Index	TITLE	Type	Total Hours
-------------	--------------	--------------	-------------	--------------------

PEREZ,BENITO O

L5952 OAID/SNOW Operating 22

PPSA - Strategic Planning Branch

Name	Index	TITLE	Type	Total Hours
BOOKER,LEWIS C	L5952	OAID/SNOW	Operating	19

PSRA - Customer Service

Name	Index	TITLE	Type	Total Hours
BENSON,TALAT	CA582	INSP-Inspection & Investigation	Indirect	16
	L5952	OAID/SNOW	Operating	13
DOGGETT,QUARTNE	L5952	OAID/SNOW	Operating	30
	L7050	DEPARTMENT OF TRANSPORTATION	Operating	76
GRIER,PAMELA P	L5952	OAID/SNOW	Operating	12
MARTIN,KIANA	L7022	DEPARTMENT OF TRANSPORTATION	Operating	10
	L5952	OAID/SNOW	Operating	12
TENBROOK,TIFFANY	L5952	OAID/SNOW	Operating	12
	L7100	DEPARTMENT OF TRANSPORTATION	Operating	4

PSRA - Inspections

Name	Index	TITLE	Type	Total Hours
BALL,CHERYL B	L5952	OAID/SNOW	Operating	4
	L5802	SIOD/INSPECTIONS AND INVESTIGATIONS	Operating	31
BLUNT,GARY L	L7021	DEPARTMENT OF TRANSPORTATION	Operating	61
	L5952	OAID/SNOW	Operating	12
CARRAWAY JR,PAU	L5952	OAID/SNOW	Operating	19
COLLINS,STACEY C	L595T	Snow Training	Operating	2
	L7021	DEPARTMENT OF TRANSPORTATION	Operating	29
	L5952	OAID/SNOW	Operating	32

CRAIG,DIRK R				
	L5952	OAID/SNOW	Operating	15
GARRETT,ELLIOTT				
	L7023	DEPARTMENT OF TRANSPORTATION	Operating	4
	L5952	OAID/SNOW	Operating	12
GRAHAM,WALTER K				
	L7100	DEPARTMENT OF TRANSPORTATION	Operating	22
	L5952	OAID/SNOW	Operating	19
HENRY,JAMES T				
	L5952	OAID/SNOW	Operating	21
	L7022	DEPARTMENT OF TRANSPORTATION	Operating	10
HILL JR,DAVID W				
	L5952	OAID/SNOW	Operating	16
	L595T	Snow Training	Operating	3
	L7022	DEPARTMENT OF TRANSPORTATION	Operating	45
JERNAGIN,MICHAEL				
	L5952	OAID/SNOW	Operating	4
	L7022	DEPARTMENT OF TRANSPORTATION	Operating	37
KING,CHARLES				
	L7022	DEPARTMENT OF TRANSPORTATION	Operating	65
	L595T	Snow Training	Operating	20
LEE,ROBERT K				
	L5952	OAID/SNOW	Operating	19
MATTHEWS,VACAR				
	L5952	OAID/SNOW	Operating	12
MCFADDEN,MARVI				
	L595T	Snow Training	Operating	3
	L7023	DEPARTMENT OF TRANSPORTATION	Operating	64
	L5952	OAID/SNOW	Operating	32
MCLEOD,RAYMOND				
	L5952	OAID/SNOW	Operating	19
	L7022	DEPARTMENT OF TRANSPORTATION	Operating	37
NORRIS,DWAYNE K				
	L595T	Snow Training	Operating	3
	L7021	DEPARTMENT OF TRANSPORTATION	Operating	44

SUMMERS,MILDRED

L5952	OAID/SNOW	Operating	19
L7021	DEPARTMENT OF TRANSPORTATION	Operating	33

TOYER,KENNETH J

L7023	DEPARTMENT OF TRANSPORTATION	Operating	40
-------	------------------------------	-----------	----

TURNER,NATHANIE

L5952	OAID/SNOW	Operating	19
-------	-----------	-----------	----

WELLS,DAVID

L5952	OAID/SNOW	Operating	26
L7021	DEPARTMENT OF TRANSPORTATION	Operating	58

WHITE,ROBERT L

L5952	OAID/SNOW	Operating	14
L7023	DEPARTMENT OF TRANSPORTATION	Operating	45

PSRA - Permits

Name	Index	TITLE	Type	Total Hours
FELDER,CATRINA I	L7030	DEPARTMENT OF TRANSPORTATION	Operating	8
	L5952	OAID/SNOW	Operating	34
GAMIL,YASSER M	L7030	DEPARTMENT OF TRANSPORTATION	Operating	3
	L5ALY	Rally for the Alley	Operating	19
	L5952	OAID/SNOW	Operating	24
HARRIS,MALINDA G	L7030	DEPARTMENT OF TRANSPORTATION	Operating	8
JONES,SHANNON RE	L595T	Snow Training	Operating	3
	L5952	OAID/SNOW	Operating	28
	L5ALY	Rally for the Alley	Operating	13
	L3OVT	StreetCar - Overtime	Operating	90
	L7030	DEPARTMENT OF TRANSPORTATION	Operating	16
PEARSON,CURTIS R	L7030	DEPARTMENT OF TRANSPORTATION	Operating	5

PSRA - Plan Review

Name	Index	TITLE	Type	Total Hours
ALLEN,KISHA	L7040	Plan and Review	Operating	4

DICKENS,CHARLENE

L5688	March for Life Rally - Jan 22	Operating	6
L5685	"Justice or Else!" Million Man	Operating	12
L5952	OAID/SNOW	Operating	12

EDOKWE,EDWIN

L5952	OAID/SNOW	Operating	18
-------	-----------	-----------	----

MEADERS,KEENAN

L5952	OAID/SNOW	Operating	12
-------	-----------	-----------	----

STOKES,JOHN

L7030	DEPARTMENT OF TRANSPORTATION	Operating	2
-------	------------------------------	-----------	---

WAKE,FIKRU T

L5952	OAID/SNOW	Operating	12
-------	-----------	-----------	----

PTSA - Mass Transit Division

Name	Index	TITLE	Type	Total Hours
-------------	--------------	--------------	-------------	--------------------

BASSETT LOWE,JOA

L3001	SCHOOL SUBSIDY PROGRAM	Operating	4
-------	------------------------	-----------	---

BUNDY,ANTHONY C

L5952	OAID/SNOW	Operating	12
L3OVT	StreetCar - Overtime	Operating	4
L595T	Snow Training	Operating	3

GROSS JR,NORMAN

C1120	OD-Contracts	Indirect	4
L3OVT	StreetCar - Overtime	Operating	4

JOHNSON,ANGELICA

L3002	MASS TRANSIT	Operating	6
-------	--------------	-----------	---

TORRUELLAS,CIRCE

L5952	OAID/SNOW	Operating	3
-------	-----------	-----------	---

PTSA - Progressive Transportation Ser

Name	Index	TITLE	Type	Total Hours
-------------	--------------	--------------	-------------	--------------------

JACOBI,AMY E

L5952	OAID/SNOW	Operating	13
L3OVT	StreetCar - Overtime	Operating	20

PTSA - StreetCar Development Division

Name	Index	TITLE	Type	Total Hours
-------------	--------------	--------------	-------------	--------------------

CHISM,JOHN P

T4085	StreetCars	Direct	58
L3OVT	StreetCar - Overtime	Operating	93
L5952	OAID/SNOW	Operating	15
L595T	Snow Training	Operating	5

PTSA - Transportation Business Unit

Name	Index	TITLE	Type	Total Hours
BENTON,JAMES				
	L3043	DEPARTMENT OF TRANSPORTATION	Operating	60
	L3OVT	StreetCar - Overtime	Operating	87
RICH,VICTORY J				
	L3002	MASS TRANSIT	Operating	68
	L5952	OAID/SNOW	Operating	29
	L595T	Snow Training	Operating	1

Resource Management - Resource Management

Name	Index	TITLE	Type	Total Hours
DANIEL,PHILLIP S				
	L595T	Snow Training	Operating	4
	L5952	OAID/SNOW	Operating	16
DARE,EVELYN				
	L595T	Snow Training	Operating	2
LOVE,LAKISHA				
	L5952	OAID/SNOW	Operating	16
	L5685	"Justice or Else!" Million Man	Operating	12
STULTS,ERIC W				
	L5952	OAID/SNOW	Operating	12

TOA - Alley Paving Unit

Name	Index	TITLE	Type	Total Hours
BELL JR,THOMAS H				
	CA521	RMAS-Roadway Maint Section	Indirect	13
MATHIS,REGINALD				
	L5204	STBM/HEAVY EQUIPMENT OPERATIONS SECTION	Operating	8
MORRIS,ROBERT H				
	CA521	RMAS-Roadway Maint Section	Indirect	47
	L5952	OAID/SNOW	Operating	12

SHORTER,GREGORY

L5952 OAIID/SNOW Operating 12

WILLIAMS,ANDREA

CA521 RMAAS-Roadway Maint Section Indirect 38

L5952 OAIID/SNOW Operating 18

TOA - Automated Graphic & Design Fab

Name Index TITLE Type Total Hours

THOMAS,HAROLD A

CA512 PAVW-Pavmt Mrking Ward 1-8 Indirect 8

CA516 FAVR-Sign Fabrication Indirect 20

L5952 OAIID/SNOW Operating 4

WANZER,JAMIE

CA512 PAVW-Pavmt Mrking Ward 1-8 Indirect 7

CA516 FAVR-Sign Fabrication Indirect 16

TOA - Bridge & Street Maintenance

Name Index TITLE Type Total Hours

AJAGBA,LAURITA

L595T Snow Training Operating 10

L5952 OAIID/SNOW Operating 15

L5202 STBM/ROADWAY MAINTENANCE SECTION Operating 2

BURNETTE,ANTONI

L5204 STBM/HEAVY EQUIPMENT OPERATIONS SECTION Operating 71

L5952 OAIID/SNOW Operating 12

L595T Snow Training Operating 13

CALLAHAM,ROBERT

L5021 TSFO - FLEET MANAGEMENT Operating 94

L5952 OAIID/SNOW Operating 4

JACKSON,MICHAEL

L5952 OAIID/SNOW Operating 14

L5204 STBM/HEAVY EQUIPMENT OPERATIONS SECTION Operating 118

LUCAS,CHALL A

L5952 OAIID/SNOW Operating 1

L5802 SIOD/INSPECTIONS AND INVESTIGATIONS Operating 43

L595T Snow Training Operating 3

MARSHALL,CELICIA

L5952 OAIID/SNOW Operating 2

MCKINNEY,RICARD				
	22770	DEPARTMENT OF TRANSPORTATION	Indirect	66
	L5952	OAID/SNOW	Operating	8
	L595T	Snow Training	Operating	4
MILLER,LORENZO O				
	L5005	TSFO/WAREHOUSE SECTION	Operating	38
	L5952	OAID/SNOW	Operating	22
NOBLES,DERRICK J				
	L5952	OAID/SNOW	Operating	10
	L5802	SIOD/INSPECTIONS AND INVESTIGATIONS	Operating	3
PETTUS,ANGELA L				
	L5952	OAID/SNOW	Operating	14
SALMON,WILLIE M				
	CA521	RMAS-Roadway Maint Section	Indirect	84
	L5952	OAID/SNOW	Operating	21
	L595T	Snow Training	Operating	4
SMITH,KENNETH W				
	L5201	TSFO/RODWAY REPAIR SECTION	Operating	26
	L5952	OAID/SNOW	Operating	13
SMITH,ROBERT E				
	CA574	SSIG-Signals	Indirect	84
	L5952	OAID/SNOW	Operating	16
SYKES,CLARENCE R				
	L595T	Snow Training	Operating	5
	L5952	OAID/SNOW	Operating	17
	L5204	STBM/HEAVY EQUIPMENT OPERATIONS SECTION	Operating	136
	L5202	STBM/ROADWAY MAINTENANCE SECTION	Operating	8

TOA - Bridge Operations Unit

Name	Index	TITLE	Type	Total Hours
DAWKINS,MICHAEL				
	32770	DEPARTMENT OF TRANSPORTATION	Indirect	5
	L5952	OAID/SNOW	Operating	12
JACKSON,GARY J				
	T4513	FY10 Constultant Bridge Insp	Direct	15
	L5201	TSFO/RODWAY REPAIR SECTION	Operating	155
	L5952	OAID/SNOW	Operating	4

MCNEELY,ROBERT				
	CA522	RRES-Roadway Repair Section	Indirect	65
PHILLIPS,CORNELIO				
	L5201	TSFO/RODWAY REPAIR SECTION	Operating	36
	L5684	POPE FRANCIS VISIT 2015	Operating	4
	L5952	OAID/SNOW	Operating	17
SIMPSON,TENSLY				
	L5952	OAID/SNOW	Operating	12
	L5201	TSFO/RODWAY REPAIR SECTION	Operating	65
TAYLOR JR,JULIUS				
	L5201	TSFO/RODWAY REPAIR SECTION	Operating	70
TAYLOR,ROBERT				
	L5201	TSFO/RODWAY REPAIR SECTION	Operating	14
WHEELER,KEONNE				
	L5952	OAID/SNOW	Operating	23
WILSON,MICHAEL E				
	L5952	OAID/SNOW	Operating	12
	L5201	TSFO/RODWAY REPAIR SECTION	Operating	122

TOA - City-Wide Division

Name	Index	TITLE	Type	Total Hours
BAGA,CHERWIN L				
	T4805	Streetlight Asset Mgmt	Direct	23
	T4085	StreetCars	Direct	3
	CA582	INSP-Inspection & Investigation	Indirect	5
	L5952	OAID/SNOW	Operating	24
	L595T	Snow Training	Operating	3
HAZLETT,REBECCA				
	L5952	OAID/SNOW	Operating	14
LYLE,JERRY L				
	L5952	OAID/SNOW	Operating	13
	L5902	CWPS/PARKING OPERATIONS	Operating	4
PATTERSON,EVIAN				
	L5903	CWPS/ADMIN SUPPORT	Operating	4
	L5952	OAID/SNOW	Operating	13

TOA - Crack Seal Unit

Name	Index	TITLE	Type	Total Hours
------	-------	-------	------	-------------

CHAPPELLE,BARRIN

L5204	STBM/HEAVY EQUIPMENT OPERATIONS SECTION	Operating	70
L5952	OAID/SNOW	Operating	13

GRIMES,ROBERT D

CA521	RMAS-Roadway Maint Section	Indirect	61
L5952	OAID/SNOW	Operating	18
L595T	Snow Training	Operating	4

LEARY,SANTINI

T4984	Street Sign Improvments	Direct	26
L5952	OAID/SNOW	Operating	18

LOTT,JOANELL S

L5952	OAID/SNOW	Operating	26
L5201	TSFO/RODWAY REPAIR SECTION	Operating	65
L5684	POPE FRANCIS VISIT 2015	Operating	12
L595T	Snow Training	Operating	5

WILLIS,BARBARA J

CA521	RMAS-Roadway Maint Section	Indirect	92
L5952	OAID/SNOW	Operating	22
L595T	Snow Training	Operating	4

TOA - Equipment Maintenance Unit

Name	Index	TITLE	Type	Total Hours
BAXTER,DONALD				
	CA521	RMAS-Roadway Maint Section	Indirect	127
	L5952	OAID/SNOW	Operating	36

TOA - Fleet Management

Name	Index	TITLE	Type	Total Hours
DAVIS,VICKI				
	L5952	OAID/SNOW	Operating	12

TOA - Heavy Equipment Operations Sec

Name	Index	TITLE	Type	Total Hours
HAZEL,ROBERT D				
	L5204	STBM/HEAVY EQUIPMENT OPERATIONS SECTION	Operating	57
	L5952	OAID/SNOW	Operating	20

TOA - ITS Support Traffic Signals &

Name	Index	TITLE	Type	Total Hours
------	-------	-------	------	-------------

COOPER,TAWEH H				
	L5952	OAID/SNOW	Operating	23
HARVIN,CHERYL				
	K0470	Capital Crossing Development	Direct	12
JOHNSON,JERMAINE				
	L5952	OAID/SNOW	Operating	12
LINDSAY,QUINN				
	K0470	Capital Crossing Development	Direct	8
	L5952	OAID/SNOW	Operating	12
PATTERSON,CORBIN				
	T4547	FY10 Traffic Signal Construction	Direct	8
	L5952	OAID/SNOW	Operating	12
TAYLOR,CHAUNCEY				
	K0470	Capital Crossing Development	Direct	8

TOA - ITS Systems Support Branch

Name	Index	TITLE	Type	Total Hours
ROYAL,JAMES				
	T4910	ITS MAINTENANCE	Direct	8
	L5952	OAID/SNOW	Operating	12

TOA - Layout Crew

Name	Index	TITLE	Type	Total Hours
HART,RODNEY L				
	CA512	PAVW-Pavmt Mrking Ward 1-8	Indirect	63
	L595T	Snow Training	Operating	12

TOA - Maintainer Unit

Name	Index	TITLE	Type	Total Hours
MODENESSI I,VICTO				
	CA522	RRES-Roadway Repair Section	Indirect	34
	L5952	OAID/SNOW	Operating	12
NELSON,MICHAEL J				
	L5952	OAID/SNOW	Operating	16
	L5204	STBM/HEAVY EQUIPMENT OPERATIONS SECTION	Operating	118
TREADWELL,JOHNNI				
	L5952	OAID/SNOW	Operating	12

TOA - Milling/Spray Patch Unit

Name	Index	TITLE	Type	Total Hours
------	-------	-------	------	-------------

GAINES,ARMELL				
	L5952	OAID/SNOW	Operating	12
GROSS,MYRON				
	CA522	RRES-Roadway Repair Section	Indirect	37
	L5952	OAID/SNOW	Operating	12
JOHNSON,DONALD E				
	L5952	OAID/SNOW	Operating	28
	L5201	TSFO/RODWAY REPAIR SECTION	Operating	93
LANCASTER,CLIFFO				
	L5201	TSFO/RODWAY REPAIR SECTION	Operating	90
	L5952	OAID/SNOW	Operating	21
MILLER,ANTHONY D				
	CA522	RRES-Roadway Repair Section	Indirect	64
	32770	DEPARTMENT OF TRANSPORTATION	Indirect	26
MILLER,GEORGE J				
	L5204	STBM/HEAVY EQUIPMENT OPERATIONS SECTION	Operating	40
	L5952	OAID/SNOW	Operating	8
WHEELER,BENJAMI				
	L5201	TSFO/RODWAY REPAIR SECTION	Operating	23
	L595T	Snow Training	Operating	5
	L5952	OAID/SNOW	Operating	13

TOA - Office of the Associate Direct

Name	Index	TITLE	Type	Total Hours
MULDROW,KIM L				
	L5952	OAID/SNOW	Operating	14
	L5951	OAID/ADMIN SUPPORT	Operating	8

TOA - Parking Operations Branch

Name	Index	TITLE	Type	Total Hours
MILLER,MICHAEL T				
	L5952	OAID/SNOW	Operating	8
	L5902	CWPS/PARKING OPERATIONS	Operating	4

TOA - Pavement Marking Crew

Name	Index	TITLE	Type	Total Hours
RICHARDSON,LEMA				
	CA512	PAVW-Pavmt Mrking Ward 1-8	Indirect	49

WILKS,TODD SYLVE				
	CA512	PAVW-Pavmt Mrking Ward 1-8	Indirect	67
	L5952	OAID/SNOW	Operating	16

TOA - Paving Unit

Name	Index	TITLE	Type	Total Hours
BROWN,MICHAEL L				
	CA521	RMAS-Roadway Maint Section	Indirect	18
	L5952	OAID/SNOW	Operating	12
	L595T	Snow Training	Operating	4
CLAYTON,JAMES				
	L5952	OAID/SNOW	Operating	13
HOLMAN,TERRI B				
	L5204	STBM/HEAVY EQUIPMENT OPERATIONS SECTION	Operating	35
JACKSON,GARRETT				
	L5201	TSFO/RODWAY REPAIR SECTION	Operating	24
SHORT,RASHAAD D				
	L5952	OAID/SNOW	Operating	16
	L595T	Snow Training	Operating	5
	L5204	STBM/HEAVY EQUIPMENT OPERATIONS SECTION	Operating	50
THOMPSON JR,LUCU				
	L5952	OAID/SNOW	Operating	14
	L5204	STBM/HEAVY EQUIPMENT OPERATIONS SECTION	Operating	41

TOA - Roadway Maintenance Section

Name	Index	TITLE	Type	Total Hours
BROOKS,KIPCHOEGIE				
	CA521	RMAS-Roadway Maint Section	Indirect	14
	L5952	OAID/SNOW	Operating	2
JONES,ROLAND D				
	L5952	OAID/SNOW	Operating	27
	L5201	TSFO/RODWAY REPAIR SECTION	Operating	83
PATTERSON,JERMAI				
	63970	DEPARTMENT OF TRANSPORTATION	Indirect	54
	L5952	OAID/SNOW	Operating	19

TOA - Roadway Operations Branch

Name	Index	TITLE	Type	Total Hours
------	-------	-------	------	-------------

BROOKS,KEVIN L				
T4908	ROADWAY OP PATROL	Direct		8
T4513	FY10 Constultant Bridge Insp	Direct		22
CA520	Roadway Operations Unit	Indirect		14
L5952	OAID/SNOW	Operating		16
DEARING,MICHELE				
L5402	TOTM/TRAFFIC CONTROL OPERATIONS	Operating		10
L5952	OAID/SNOW	Operating		24
FIELDS,WARREN L				
T4908	ROADWAY OP PATROL	Direct		24
T4513	FY10 Constultant Bridge Insp	Direct		8
L5952	OAID/SNOW	Operating		16
HONESTY-BEY,CHIE				
T4908	ROADWAY OP PATROL	Direct		28
L5952	OAID/SNOW	Operating		16
MAKLE JR,ALBERT				
T4908	ROADWAY OP PATROL	Direct		16
T4513	FY10 Constultant Bridge Insp	Direct		27
MASON,BRADLEY L				
T4908	ROADWAY OP PATROL	Direct		68
L5952	OAID/SNOW	Operating		24
MCCREA,DONNA J				
CA520	Roadway Operations Unit	Indirect		1
L5952	OAID/SNOW	Operating		12
RILEY,SIGBEE D				
T4908	ROADWAY OP PATROL	Direct		28
SHANNON,ERIC A				
T4908	ROADWAY OP PATROL	Direct		24
CA520	Roadway Operations Unit	Indirect		20
L5952	OAID/SNOW	Operating		8
SKEEN,TYRONE				
T4513	FY10 Constultant Bridge Insp	Direct		9
T4805	Streetlight Asset Mgmt	Direct		1
T4908	ROADWAY OP PATROL	Direct		47
L5952	OAID/SNOW	Operating		4

WARREN,DARREN R

T4908	ROADWAY OP PATROL	Direct	16
T4513	FY10 Constultant Bridge Insp	Direct	17
T4805	Streetlight Asset Mgmt	Direct	6
CA520	Roadway Operations Unit	Indirect	42
L5952	OAID/SNOW	Operating	16

WILSON,JEREMY B

T4805	Streetlight Asset Mgmt	Direct	5
T4513	FY10 Constultant Bridge Insp	Direct	8
T4908	ROADWAY OP PATROL	Direct	9
CA520	Roadway Operations Unit	Indirect	9
L5952	OAID/SNOW	Operating	4

TOA - Safety Standard & Oversight

Name	Index	TITLE	Type	Total Hours
-------------	--------------	--------------	-------------	--------------------

HARDY SR,DERRICK

L5952	OAID/SNOW	Operating	24
-------	-----------	-----------	----

JAIN,RAHUL P

L5952	OAID/SNOW	Operating	14
-------	-----------	-----------	----

MILES,KENDRICK M

T4085	StreetCars	Direct	3
L3OVT	StreetCar - Overtime	Operating	16
L595T	Snow Training	Operating	2
L5952	OAID/SNOW	Operating	20

TOA - School Crossing Control Progra

Name	Index	TITLE	Type	Total Hours
-------------	--------------	--------------	-------------	--------------------

BROWN,JEROME

L5401	TOTM/SCHOOL CROSSING GUARD	Operating	30
-------	----------------------------	-----------	----

CHAPMAN,LINDA P

L5401	TOTM/SCHOOL CROSSING GUARD	Operating	26
-------	----------------------------	-----------	----

COPELAND,DOMINI

L5401	TOTM/SCHOOL CROSSING GUARD	Operating	15
-------	----------------------------	-----------	----

DUNBAR,SYMRA

L5401	TOTM/SCHOOL CROSSING GUARD	Operating	21
-------	----------------------------	-----------	----

GIBBS,KEVIN

L5401	TOTM/SCHOOL CROSSING GUARD	Operating	16
-------	----------------------------	-----------	----

GRIFFIN,BILLY	L5401	TOTM/SCHOOL CROSSING GUARD	Operating	24
HALL,JENNIFER R	L7100	DEPARTMENT OF TRANSPORTATION	Operating	40
HORNE,ERROL	L5952	OAID/SNOW	Operating	2
HUNTER,JAMES	L5402	TOTM/TRAFFIC CONTROL OPERATIONS	Operating	8
LEE,ANGELA	L5402	TOTM/TRAFFIC CONTROL OPERATIONS	Operating	24
MORTON,PATRICIA	L5401	TOTM/SCHOOL CROSSING GUARD	Operating	1
WALKER,DEBRA	L5401	TOTM/SCHOOL CROSSING GUARD	Operating	7
WATSON,LONNIE R	L5401	TOTM/SCHOOL CROSSING GUARD	Operating	44
WILKINSON,DARREL	L5952	OAID/SNOW	Operating	12
	L5201	TSFO/RODWAY REPAIR SECTION	Operating	27
YOUNG,PRINCETON	L5401	TOTM/SCHOOL CROSSING GUARD	Operating	10

TOA - Sidewalk/Concrete Brick Mainte

Name	Index	TITLE	Type	Total Hours
BELL,ANTHONY	L5952	OAID/SNOW	Operating	13
	L5204	STBM/HEAVY EQUIPMENT OPERATIONS SECTION	Operating	60
CANNING,SEAN A	CA520	Roadway Operations Unit	Indirect	39
	L5952	OAID/SNOW	Operating	12
COATES,MATHEW H	L5202	STBM/ROADWAY MAINTENANCE SECTION	Operating	54
	L5952	OAID/SNOW	Operating	12
JONES,STEVEN W	L5952	OAID/SNOW	Operating	27
	L595T	Snow Training	Operating	4
	L5202	STBM/ROADWAY MAINTENANCE SECTION	Operating	29

SIMS,DEAN

L5202	STBM/ROADWAY MAINTENANCE SECTION	Operating	73
L5952	OAID/SNOW	Operating	12

TOA - Sign Installation Team (Teams)

Name	Index	TITLE	Type	Total Hours
BARNES,LEON C				
	T4984	Street Sign Improvments	Direct	18
	L5952	OAID/SNOW	Operating	18
BERRY,JAMES S				
	T4984	Street Sign Improvments	Direct	49
	L5952	OAID/SNOW	Operating	12
CLAGGETT,ERIC A				
	T4984	Street Sign Improvments	Direct	18
	CA511	SIGW-Sign Inst, Remvl Ward 1-8	Indirect	45
	L5952	OAID/SNOW	Operating	16
COLE,CARLOS DAM				
	T4984	Street Sign Improvments	Direct	26
	L595T	Snow Training	Operating	4
GASTON,LAVALLE E				
	T4984	Street Sign Improvments	Direct	16
	CA511	SIGW-Sign Inst, Remvl Ward 1-8	Indirect	26
	L5952	OAID/SNOW	Operating	12
JAKES,PHYLLIS				
	CA511	SIGW-Sign Inst, Remvl Ward 1-8	Indirect	46
LEWIS,YAZID				
	CA511	SIGW-Sign Inst, Remvl Ward 1-8	Indirect	16
	L5952	OAID/SNOW	Operating	12
MILLER JR,EDWARD				
	T4984	Street Sign Improvments	Direct	76
	L595T	Snow Training	Operating	4
PAYTON,ROBERT L				
	L5952	OAID/SNOW	Operating	12
PHILSON,MAURICE				
	L5952	OAID/SNOW	Operating	12

RICHARDSON,MAUR

CA511	SIGW-Sign Inst, Remvl Ward 1-8	Indirect	18
L5952	OAID/SNOW	Operating	12

STREET,JASON

T4984	Street Sign Improvments	Direct	20
CA511	SIGW-Sign Inst, Remvl Ward 1-8	Indirect	18
L5952	OAID/SNOW	Operating	12

WILSON,WILLIAM E

CA511	SIGW-Sign Inst, Remvl Ward 1-8	Indirect	18
L595T	Snow Training	Operating	4

TOA - Sign Painting Crew

Name	Index	TITLE	Type	Total Hours
REED,SHELLEY D				
	CA512	PAVW-Pavmt Mrking Ward 1-8	Indirect	4
	CA516	FAVR-Sign Fabrication	Indirect	55
	L5952	OAID/SNOW	Operating	12
SAUNDERS-JONES,D				
	CA516	FAVR-Sign Fabrication	Indirect	57
	L5952	OAID/SNOW	Operating	17
WAHAB,MOHAMMA				
	CA512	PAVW-Pavmt Mrking Ward 1-8	Indirect	8
	CA516	FAVR-Sign Fabrication	Indirect	24

TOA - Speed Hump Unit

Name	Index	TITLE	Type	Total Hours
ELLERBE,KEITH R				
	CA521	RMAS-Roadway Maint Section	Indirect	38
	L5952	OAID/SNOW	Operating	12
ELLIS,DANIEL				
	L5952	OAID/SNOW	Operating	26
	L5204	STBM/HEAVY EQUIPMENT OPERATIONS SECTION	Operating	90
	L595T	Snow Training	Operating	5
HOES,LAWRENCE E				
	CA521	RMAS-Roadway Maint Section	Indirect	11
ROSEBAR,RICHARD				
	CA521	RMAS-Roadway Maint Section	Indirect	100
	L5952	OAID/SNOW	Operating	12

SILVA,JOSE C

CA521	RMAS-Roadway Maint Section	Indirect	23
L5952	OAID/SNOW	Operating	6
L595T	Snow Training	Operating	4

TOA - Streetlight Operations Branch

Name	Index	TITLE	Type	Total Hours
-------------	--------------	--------------	-------------	--------------------

BLEVINS,JASON C

T4682	FY11 CW Stlight Asset Manageme	Direct	5
T4805	Streetlight Asset Mgmt	Direct	8
T4684	FY11 CW Stlight Asset Manageme	Direct	10
L5952	OAID/SNOW	Operating	26

GROSS,STEVEN

T4805	Streetlight Asset Mgmt	Direct	31
L5952	OAID/SNOW	Operating	21

KENNEY,BRENDA L

T4684	FY11 CW Stlight Asset Manageme	Direct	23
L5952	OAID/SNOW	Operating	29

LAWSON,ANTHONY

CA593	STLG-Street Light Operation	Indirect	8
L5952	OAID/SNOW	Operating	12

NGUYEN,TAN H

T4682	FY11 CW Stlight Asset Manageme	Direct	8
T4085	StreetCars	Direct	8
T4805	Streetlight Asset Mgmt	Direct	21
L5952	OAID/SNOW	Operating	21

SCHOOLS,JOHN J

T4805	Streetlight Asset Mgmt	Direct	8
CA593	STLG-Street Light Operation	Indirect	34
L5952	OAID/SNOW	Operating	28

TOA - System Inspection & Oversight

Name	Index	TITLE	Type	Total Hours
-------------	--------------	--------------	-------------	--------------------

EDMONDS,FRANCIN

L5952	OAID/SNOW	Operating	20
L5010	TSFO- ADMIN SUPPORT	Operating	18

TOA - TOA

Name	Index	TITLE	Type	Total Hours
-------------	--------------	--------------	-------------	--------------------

ALEXANDER JR,HAR				
	L5952	OAID/SNOW	Operating	12
BROWDER,CLARK K				
	T4910	ITS MAINTENANCE	Direct	12
	L5952	OAID/SNOW	Operating	12
BULLUCK,ADRIAN				
	L595T	Snow Training	Operating	2
	L5952	OAID/SNOW	Operating	14
COOPER,RANDOLPH				
	K0470	Capital Crossing Development	Direct	8
	L5952	OAID/SNOW	Operating	16
DAVIS,GEORGE O				
	L5952	OAID/SNOW	Operating	16
DINKINS,ANTHONY				
	L5952	OAID/SNOW	Operating	12
GARCIA,IVAN A				
	L5952	OAID/SNOW	Operating	16
JONES,TAMMIE				
	L595T	Snow Training	Operating	12
	L5952	OAID/SNOW	Operating	33
MALLOY JR,JOSEPH				
	K0470	Capital Crossing Development	Direct	8
	L5952	OAID/SNOW	Operating	12
NGUYEN,HUNG C				
	L5952	OAID/SNOW	Operating	12
NIXON,JIMMY R				
	K0470	Capital Crossing Development	Direct	6
	T4085	StreetCars	Direct	1
	L5952	OAID/SNOW	Operating	6
	L595T	Snow Training	Operating	1
	L3OVT	StreetCar - Overtime	Operating	10
SALAH,ABDI-SALAM				
	L595T	Snow Training	Operating	3
SILER,NORMAN V				
	L5952	OAID/SNOW	Operating	16

THOMAS,JEROME

CA575 SUPP-System Support Indirect 8

WALLER,ROBERT A

T4910 ITS MAINTENANCE Direct 8

L5952 OAID/SNOW Operating 12

WOOD,JOSE R

K0470 Capital Crossing Development Direct 30

L5952 OAID/SNOW Operating 19

L5687 Christmas Tree Lighting Ceremo Operating 4

TOA - Traffic Calming City-Wide

Name Index TITLE Type Total Hours

BANKS,SHERRIE

L5802 SIOD/INSPECTIONS AND INVESTIGATIONS Operating 24

BHATIA,SANDEEP SI

CA582 INSP-Inspection & Investigation Indirect 10

L5952 OAID/SNOW Operating 12

TOA - Traffic Calming Wards 1, 2, 3

Name Index TITLE Type Total Hours

ARNO,TIANEKA P

K0520 RALLY FOR ALLYS (ALLY PALOOZA) Direct 16

CARTER,VINCENT E

CA582 INSP-Inspection & Investigation Indirect 4

HASSAN,MOHAMUD

CA582 INSP-Inspection & Investigation Indirect 32

MASON,KENNETH B

CA582 INSP-Inspection & Investigation Indirect 40

L5952 OAID/SNOW Operating 12

TOA - Traffic Calming Wards 5, 6, 7

Name Index TITLE Type Total Hours

MARROW,DERRICK

L3OVT StreetCar - Overtime Operating 8

TOA - Traffic Control Officers & Sch

Name Index TITLE Type Total Hours

BURNS,CERAY

L5402 TOTM/TRAFFIC CONTROL OPERATIONS Operating 13

L5952 OAID/SNOW Operating 3

BUTLER,SARAH				
	L595T	Snow Training	Operating	8
	L5952	OAID/SNOW	Operating	24
	L5687	Christmas Tree Lighting Ceremo	Operating	9
	L5402	TOTM/TRAFFIC CONTROL OPERATIONS	Operating	24
DAVIS THOMAS,JAC				
	L595T	Snow Training	Operating	14
	L5952	OAID/SNOW	Operating	14
DIAL,LAMONT				
	L5402	TOTM/TRAFFIC CONTROL OPERATIONS	Operating	9
ELLIS,GENEVA E				
	L5952	OAID/SNOW	Operating	20
	L595T	Snow Training	Operating	8
MORGAN,KENITA N				
	L5402	TOTM/TRAFFIC CONTROL OPERATIONS	Operating	18
RAMIREZ,ROBERTO				
	L5402	TOTM/TRAFFIC CONTROL OPERATIONS	Operating	9
STRANGE,JAMES E				
	T4908	ROADWAY OP PATROL	Direct	1
	T4907	TMC OPS / SPEC EVENTS	Direct	2
	L5952	OAID/SNOW	Operating	19
	L5687	Christmas Tree Lighting Ceremo	Operating	3
WREN-PERKINS,NET				
	L5402	TOTM/TRAFFIC CONTROL OPERATIONS	Operating	18
	L5952	OAID/SNOW	Operating	5
YOUNG,DANIELLE T				
	L595T	Snow Training	Operating	2
	L5401	TOTM/SCHOOL CROSSING GUARD	Operating	4
	L5952	OAID/SNOW	Operating	18

TOA - Traffic Control Officers Progr

Name	Index	TITLE	Type	Total Hours
AMBROSE,ERIC A				
	L5402	TOTM/TRAFFIC CONTROL OPERATIONS	Operating	96
	L5952	OAID/SNOW	Operating	12
BAILEY,LACRESHA				
	L5402	TOTM/TRAFFIC CONTROL OPERATIONS	Operating	9

BAILEY, TYREESE M				
	L5952	OAID/SNOW	Operating	12
BARNES, JEROME				
	L5402	TOTM/TRAFFIC CONTROL OPERATIONS	Operating	9
BAUMGARDNER, ARI				
	L5952	OAID/SNOW	Operating	2
	L5402	TOTM/TRAFFIC CONTROL OPERATIONS	Operating	1
BEEKS, WANDA				
	L5402	TOTM/TRAFFIC CONTROL OPERATIONS	Operating	24
BELL, DAWNETTA L				
	L5952	OAID/SNOW	Operating	2
	L5402	TOTM/TRAFFIC CONTROL OPERATIONS	Operating	16
BLANDING, ASHLEY				
	L5402	TOTM/TRAFFIC CONTROL OPERATIONS	Operating	20
BLOUNT JR, MILTON				
	L5402	TOTM/TRAFFIC CONTROL OPERATIONS	Operating	9
	L5952	OAID/SNOW	Operating	2
BOARDLEY, RAMON				
	L5952	OAID/SNOW	Operating	1
	L5402	TOTM/TRAFFIC CONTROL OPERATIONS	Operating	25
CATO, PRESTON L				
	L5402	TOTM/TRAFFIC CONTROL OPERATIONS	Operating	25
CHASE, JOYCE H				
	L5402	TOTM/TRAFFIC CONTROL OPERATIONS	Operating	17
CLAGGETT, DELONT				
	L5952	OAID/SNOW	Operating	2
	L5402	TOTM/TRAFFIC CONTROL OPERATIONS	Operating	1
CRAIG, CIERRA M				
	L5952	OAID/SNOW	Operating	12
	L5402	TOTM/TRAFFIC CONTROL OPERATIONS	Operating	11
DANIEL, ISIAAH				
	L5402	TOTM/TRAFFIC CONTROL OPERATIONS	Operating	9
	L5952	OAID/SNOW	Operating	2

DAVIS,RONETTA				
L5402	TOTM/TRAFFIC CONTROL OPERATIONS	Operating	21	
L5687	Christmas Tree Lighting Ceremo	Operating	9	
L595T	Snow Training	Operating	6	
DAVIS,RUQAYYA R				
L5402	TOTM/TRAFFIC CONTROL OPERATIONS	Operating	9	
DYSON,DIMITRI				
L5402	TOTM/TRAFFIC CONTROL OPERATIONS	Operating	17	
L5952	OAID/SNOW	Operating	2	
ELLINGTON,TRACEY				
L5952	OAID/SNOW	Operating	8	
FIELDS,AMBER MAR				
L5952	OAID/SNOW	Operating	12	
L5402	TOTM/TRAFFIC CONTROL OPERATIONS	Operating	16	
FLEMING,JANET L				
L595T	Snow Training	Operating	3	
FORD,RAYSHAWN				
L5402	TOTM/TRAFFIC CONTROL OPERATIONS	Operating	9	
FRANKS-DUNBAR,S				
L5402	TOTM/TRAFFIC CONTROL OPERATIONS	Operating	25	
GODFREY,JASON G				
L5952	OAID/SNOW	Operating	26	
L5402	TOTM/TRAFFIC CONTROL OPERATIONS	Operating	6	
L5687	Christmas Tree Lighting Ceremo	Operating	10	
GRAHAM,LAQUANT				
L5952	OAID/SNOW	Operating	12	
GRANT-JONES,STER				
L5952	OAID/SNOW	Operating	14	
GRAVES,JERMONT D				
L5402	TOTM/TRAFFIC CONTROL OPERATIONS	Operating	13	
GRAY,YETTA F				
L5687	Christmas Tree Lighting Ceremo	Operating	9	
L5402	TOTM/TRAFFIC CONTROL OPERATIONS	Operating	9	
GREEN,ANGELINA L				
L5952	OAID/SNOW	Operating	6	

GREEN,CARLA D				
L5402	TOTM/TRAFFIC CONTROL OPERATIONS	Operating	24	
L5952	OAID/SNOW	Operating	24	
GREEN,ROBERT A				
T4658	STP-8888(374)FY11 FA PR	Direct	8	
L5402	TOTM/TRAFFIC CONTROL OPERATIONS	Operating	71	
HAGGINS JR,ARPELL				
L5402	TOTM/TRAFFIC CONTROL OPERATIONS	Operating	2	
HALL,MICHAEL D				
L5402	TOTM/TRAFFIC CONTROL OPERATIONS	Operating	27	
L595T	Snow Training	Operating	6	
L5952	OAID/SNOW	Operating	13	
HARGROVE,ROBERT				
L5402	TOTM/TRAFFIC CONTROL OPERATIONS	Operating	7	
HARRIS,MILLICENT				
L5952	OAID/SNOW	Operating	24	
L595T	Snow Training	Operating	8	
L5402	TOTM/TRAFFIC CONTROL OPERATIONS	Operating	28	
HERRIOT,JACK L				
L5402	TOTM/TRAFFIC CONTROL OPERATIONS	Operating	9	
HILL,GREGORY C				
L595T	Snow Training	Operating	7	
L5952	OAID/SNOW	Operating	24	
L5402	TOTM/TRAFFIC CONTROL OPERATIONS	Operating	7	
HOOKS,BEVERLY A				
L5402	TOTM/TRAFFIC CONTROL OPERATIONS	Operating	26	
L5687	Christmas Tree Lighting Ceremo	Operating	9	
L5952	OAID/SNOW	Operating	26	
L595T	Snow Training	Operating	7	
HOYLE,ROBERT BA				
L5687	Christmas Tree Lighting Ceremo	Operating	9	
JOHNSON,JENITA				
L5952	OAID/SNOW	Operating	30	
L5402	TOTM/TRAFFIC CONTROL OPERATIONS	Operating	12	
L5687	Christmas Tree Lighting Ceremo	Operating	9	

JOHNSON,PAMELA A				
	L5952	OAID/SNOW	Operating	31
JOHNSON,WENDELL				
	L5687	Christmas Tree Lighting Ceremo	Operating	10
	L5952	OAID/SNOW	Operating	2
	L5402	TOTM/TRAFFIC CONTROL OPERATIONS	Operating	9
JONES,TYWAN				
	L5687	Christmas Tree Lighting Ceremo	Operating	9
	L5952	OAID/SNOW	Operating	18
LANCASTER,ANTHO				
	L5402	TOTM/TRAFFIC CONTROL OPERATIONS	Operating	9
	L5952	OAID/SNOW	Operating	12
LEWIS,JOHN D				
	L5952	OAID/SNOW	Operating	12
LUCAS,EDWARD				
	L5402	TOTM/TRAFFIC CONTROL OPERATIONS	Operating	20
	L5952	OAID/SNOW	Operating	3
MATTOX JR,ANTHO				
	L5402	TOTM/TRAFFIC CONTROL OPERATIONS	Operating	23
	L5687	Christmas Tree Lighting Ceremo	Operating	9
MCINTYRE,LAMAR				
	L5402	TOTM/TRAFFIC CONTROL OPERATIONS	Operating	74
	L5952	OAID/SNOW	Operating	1
MCNEIL,TANESHA R				
	L5952	OAID/SNOW	Operating	12
MOBLEY,MONIQUE				
	L5952	OAID/SNOW	Operating	18
	L5687	Christmas Tree Lighting Ceremo	Operating	9
MORTON,DEBORAH				
	L595T	Snow Training	Operating	3
	L5952	OAID/SNOW	Operating	15
	L5402	TOTM/TRAFFIC CONTROL OPERATIONS	Operating	6
NICKELSON,CHARL				
	L5402	TOTM/TRAFFIC CONTROL OPERATIONS	Operating	18
	L5952	OAID/SNOW	Operating	4

OWENS,ANDRE				
	L5952	OAID/SNOW	Operating	2
PORTER,GINA				
	L5952	OAID/SNOW	Operating	23
REEDER,DARLENE E				
	L5402	TOTM/TRAFFIC CONTROL OPERATIONS	Operating	40
	L595T	Snow Training	Operating	7
	L5952	OAID/SNOW	Operating	21
	L5687	Christmas Tree Lighting Ceremo	Operating	9
ROA,LUCIA				
	L5952	OAID/SNOW	Operating	20
ROBINSON,TIMOTH				
	L5952	OAID/SNOW	Operating	6
RUSSELL,GAIL H				
	L5952	OAID/SNOW	Operating	2
SIMPSON,LAJUAN A				
	L5402	TOTM/TRAFFIC CONTROL OPERATIONS	Operating	15
	L5952	OAID/SNOW	Operating	1
SMITH,BIANCA				
	L595T	Snow Training	Operating	9
	L5952	OAID/SNOW	Operating	36
	L5402	TOTM/TRAFFIC CONTROL OPERATIONS	Operating	16
STEVE,KEVIN E				
	L5402	TOTM/TRAFFIC CONTROL OPERATIONS	Operating	55
SUMMERS,CHERYL				
	L5402	TOTM/TRAFFIC CONTROL OPERATIONS	Operating	32
	L5687	Christmas Tree Lighting Ceremo	Operating	9
	L595T	Snow Training	Operating	7
	L5952	OAID/SNOW	Operating	21
TOLSON,SHARON L				
	L5402	TOTM/TRAFFIC CONTROL OPERATIONS	Operating	-10
WALKER,AMEKA L				
	L5402	TOTM/TRAFFIC CONTROL OPERATIONS	Operating	10
WALKER,GLEN A				
	L5952	OAID/SNOW	Operating	32
	L595T	Snow Training	Operating	8

WATKINS,LORTRICE				
	L5402	TOTM/TRAFFIC CONTROL OPERATIONS	Operating	9
WEST,TRACI D				
	L5952	OAID/SNOW	Operating	18
	L5402	TOTM/TRAFFIC CONTROL OPERATIONS	Operating	4
WHEATLEY,MARVA				
	L5952	OAID/SNOW	Operating	2
WILSON,LASHAWN				
	L5952	OAID/SNOW	Operating	2
WISE,MICHAEL				
	L5402	TOTM/TRAFFIC CONTROL OPERATIONS	Operating	18
	L5952	OAID/SNOW	Operating	24

TOA - Traffic Services Field Operati

Name	Index	TITLE	Type	Total Hours
BAXTER,KIMBERLY				
	L5204	STBM/HEAVY EQUIPMENT OPERATIONS SECTION	Operating	40
	L5952	OAID/SNOW	Operating	18
DENNIS,IVAH L				
	CA512	PAVW-Pavmt Mrking Ward 1-8	Indirect	65
	L5952	OAID/SNOW	Operating	12
EVANS,SHAUNTIA M				
	L5952	OAID/SNOW	Operating	22
GREENAWAY,LATAS				
	L5952	OAID/SNOW	Operating	12
	L5010	TSFO- ADMIN SUPPORT	Operating	38
JONES,ANTHONY L				
	T4984	Street Sign Improvments	Direct	15
	CA510	TSAS - Admin Support	Indirect	18
	L5952	OAID/SNOW	Operating	12
JONES,JACQUELINE				
	L5688	March for Life Rally - Jan 22	Operating	4
	L5952	OAID/SNOW	Operating	29
	L5005	TSFO/WAREHOUSE SECTION	Operating	8

MURPHY,DANA

T4254	Thermoplastic Pavement Marking	Direct	1
L595T	Snow Training	Operating	4
L5952	OAID/SNOW	Operating	16
L5005	TSFO/WAREHOUSE SECTION	Operating	46

SMITH,CLEMENT EU

L5952	OAID/SNOW	Operating	24
-------	-----------	-----------	----

STEWART,CHARLES

L5952	OAID/SNOW	Operating	2
-------	-----------	-----------	---

WAALDIJK,DAVID S

T4984	Street Sign Improvments	Direct	24
CA512	PAVW-Pavmt Mrking Ward 1-8	Indirect	8
L5952	OAID/SNOW	Operating	2

TOA - Traffic Signal Maintenance Sec

Name	Index	TITLE	Type	Total Hours
MCINTOSH,MICHAEL	L5952	OAID/SNOW	Operating	18

TOA - Traffic Signal Section

Name	Index	TITLE	Type	Total Hours
BAILEY,BRENDA L	CA516	FAVR-Sign Fabrication	Indirect	16
	L5952	OAID/SNOW	Operating	12
	L5202	STBM/ROADWAY MAINTENANCE SECTION	Operating	4

TOA - Transportation Management Cent

Name	Index	TITLE	Type	Total Hours
AKOPIAN,EDWARD	T4907	TMC OPS / SPEC EVENTS	Direct	2
	CA530	Traffic Management Center	Indirect	10
	L5952	OAID/SNOW	Operating	8
BAILEY,LESLIE M	L5402	TOTM/TRAFFIC CONTROL OPERATIONS	Operating	8
BARKSDALE,CARLO	T4513	FY10 Constultant Bridge Insp	Direct	18
	T4805	Streetlight Asset Mgmt	Direct	16
	T4908	ROADWAY OP PATROL	Direct	98
	L5952	OAID/SNOW	Operating	16

BRANDON,JASMINE				
	L5952	OAID/SNOW	Operating	8
BROWN,VICTOR C				
	T4908	ROADWAY OP PATROL	Direct	81
	T4805	Streetlight Asset Mgmt	Direct	5
	L5952	OAID/SNOW	Operating	16
GREEN,NILLEA D				
	L5952	OAID/SNOW	Operating	24
JAMES,KEVIN L				
	T4908	ROADWAY OP PATROL	Direct	40
	T4513	FY10 Constultant Bridge Insp	Direct	9
	CA520	Roadway Operations Unit	Indirect	8
	L5952	OAID/SNOW	Operating	16
MCPHAUL JENKINS,				
	L5402	TOTM/TRAFFIC CONTROL OPERATIONS	Operating	4
OUTING,RAYTESHE				
	L5952	OAID/SNOW	Operating	16
PREE,MELONY A				
	CA524	Street & Bridge Admin	Indirect	35
	CA510	TSAS - Admin Support	Indirect	8
	L595T	Snow Training	Operating	12
	L5952	OAID/SNOW	Operating	46
ROSCOE,PHYLLIS Y				
	L5952	OAID/SNOW	Operating	4
TURNER,BENJAMIN				
	CA530	Traffic Management Center	Indirect	8
	L5952	OAID/SNOW	Operating	8
WADDY,LEON E				
	L5952	OAID/SNOW	Operating	16
WARE JR,LAWRENC				
	L5402	TOTM/TRAFFIC CONTROL OPERATIONS	Operating	4
	L5688	March for Life Rally - Jan 22	Operating	8
WILLIAMS,ALGERNO				
	L5952	OAID/SNOW	Operating	24
WINFIELD,VANESSA				
	L1090	PERFORMANCE MANAGEMENT	Operating	4

TOA - Transportation Operations Divi

Name	Index	TITLE	Type	Total Hours
ABOUSAEEDI,MAKA	L5685	"Justice or Else!" Million Man	Operating	10
HALL,MONROE D	L5952	OAID/SNOW	Operating	12
MACLIN,RASHELE A	L5952	OAID/SNOW	Operating	16
PATRICK,EUGENE P	L5952	OAID/SNOW	Operating	12

TOA - Transportation Services Team (

Name	Index	TITLE	Type	Total Hours
NWABUEZE,VICTOR	L7021	DEPARTMENT OF TRANSPORTATION	Operating	173
	L5952	OAID/SNOW	Operating	5
SARTIN,LANEL	CA582	INSP-Inspection & Investigation	Indirect	44
	L595T	Snow Training	Operating	12
	L5952	OAID/SNOW	Operating	40

TOA - Ward 1 & 2

Name	Index	TITLE	Type	Total Hours
DAWKINS,STANLEY	CA521	RMAS-Roadway Maint Section	Indirect	31
	L5202	STBM/ROADWAY MAINTENANCE SECTION	Operating	6
	L5952	OAID/SNOW	Operating	12
GAINES,JOHN F	CA521	RMAS-Roadway Maint Section	Indirect	9
	L5952	OAID/SNOW	Operating	12
WILLIAMS,JEFFREY	CA521	RMAS-Roadway Maint Section	Indirect	18
	L5952	OAID/SNOW	Operating	12

TOA - Ward 3 & 4

Name	Index	TITLE	Type	Total Hours
GARNETT,EARL	CA521	RMAS-Roadway Maint Section	Indirect	55
	L5952	OAID/SNOW	Operating	16

JOHNSON,CLIFTON				
	CA522	RRES-Roadway Repair Section	Indirect	38
	L5952	OAID/SNOW	Operating	13
LAKE,OSBORNE				
	CA521	RMAS-Roadway Maint Section	Indirect	77
	L5952	OAID/SNOW	Operating	17
MILLER,RONALD R				
	L595T	Snow Training	Operating	5
	L5952	OAID/SNOW	Operating	12
	L5202	STBM/ROADWAY MAINTENANCE SECTION	Operating	46
PARKER,JOSEPH J				
	L5952	OAID/SNOW	Operating	12
TAQEE,HASAN NAJ				
	CA521	RMAS-Roadway Maint Section	Indirect	100
	L5952	OAID/SNOW	Operating	17
WOOTEN,GEORGE A				
	CA522	RRES-Roadway Repair Section	Indirect	59
	L5952	OAID/SNOW	Operating	1
YOUNG,DOUGLAS				
	CA521	RMAS-Roadway Maint Section	Indirect	36
	L5952	OAID/SNOW	Operating	16
	L595T	Snow Training	Operating	4

TOA - Ward 5 & 6

Name	Index	TITLE	Type	Total Hours
BUTLER,MARQUES				
	L5952	OAID/SNOW	Operating	13
GAMBLE,TERRENCE				
	L5952	OAID/SNOW	Operating	26
	L5204	STBM/HEAVY EQUIPMENT OPERATIONS SECTION	Operating	52
LOVE,EUGENE				
	L5952	OAID/SNOW	Operating	26
	L5202	STBM/ROADWAY MAINTENANCE SECTION	Operating	39
ROBINSON,JUSTIN				
	L5202	STBM/ROADWAY MAINTENANCE SECTION	Operating	18
	L5952	OAID/SNOW	Operating	12

TINNER,PAULETTE E

CA521	RMAS-Roadway Maint Section	Indirect	71
L595T	Snow Training	Operating	4
L5952	OAID/SNOW	Operating	16

WEEMS,ANITRA T

CA521	RMAS-Roadway Maint Section	Indirect	48
L5952	OAID/SNOW	Operating	29

WHREN,JAMES A

CA521	RMAS-Roadway Maint Section	Indirect	2
-------	----------------------------	----------	---

TOA - Ward 7 & 8

Name	Index	TITLE	Type	Total Hours
-------------	--------------	--------------	-------------	--------------------

JOHNSON,BRENDA

CA521	RMAS-Roadway Maint Section	Indirect	13
L5952	OAID/SNOW	Operating	12

JONES,DERRICK A

CA521	RMAS-Roadway Maint Section	Indirect	19
L595T	Snow Training	Operating	4
L5952	OAID/SNOW	Operating	12

MIMS,MICHAEL R

L5204	STBM/HEAVY EQUIPMENT OPERATIONS SECTION	Operating	14
L5952	OAID/SNOW	Operating	16
L595T	Snow Training	Operating	4

OWENS,ANTHONY

CA521	RMAS-Roadway Maint Section	Indirect	9
-------	----------------------------	----------	---

SHORT,RICARDO O

CA521	RMAS-Roadway Maint Section	Indirect	73
L5952	OAID/SNOW	Operating	16

TOA - Wards 7 & 8

Name	Index	TITLE	Type	Total Hours
-------------	--------------	--------------	-------------	--------------------

WALKER,ROBERT D

L5952	OAID/SNOW	Operating	20
L5802	SIOD/INSPECTIONS AND INVESTIGATIONS	Operating	77

UFA - Field Operations Division

Name	Index	TITLE	Type	Total Hours
-------------	--------------	--------------	-------------	--------------------

CAMPBELL,NATHAN

63970	DEPARTMENT OF TRANSPORTATION	Indirect	21
-------	------------------------------	----------	----

DORSEY,ROBERT				
	L5952	OAID/SNOW	Operating	4
LEIVA,ISAIAS				
	K0164	Integrated Pest Management	Direct	8
	L5952	OAID/SNOW	Operating	4
MCKIM,SHAUN L				
	63970	DEPARTMENT OF TRANSPORTATION	Indirect	4
	L5952	OAID/SNOW	Operating	13
MILLER,JANET LEE				
	K0164	Integrated Pest Management	Direct	4
PHILLIPS,JIMMY O				
	L5952	OAID/SNOW	Operating	4
UFA - Program Operations Divisions				
Name	Index	TITLE	Type	Total Hours
BABRA,RANJIT S				
	K0164	Integrated Pest Management	Direct	12
	63970	DEPARTMENT OF TRANSPORTATION	Indirect	37
BANUA,SIMOUN				
	K0164	Integrated Pest Management	Direct	11
	L5952	OAID/SNOW	Operating	4
BURCKLE,JOSEPH H				
	L5952	OAID/SNOW	Operating	12
CHAPMAN,JACK A				
	K0164	Integrated Pest Management	Direct	8
CONLON,JOEL P				
	T4788	TREE PLANTING	Direct	8
	K0164	Integrated Pest Management	Direct	14
	L5952	OAID/SNOW	Operating	12
ERTEM,MUNEVVER				
	T4788	TREE PLANTING	Direct	2
	K0164	Integrated Pest Management	Direct	4
	L5952	OAID/SNOW	Operating	12
KLAPTHOR,CARLSO				
	L5952	OAID/SNOW	Operating	12

MCCULLY,ROBERT

L6501	GREEN PARTNERSHIP & STEWARDSHIP MGMT	Operating	10
L5952	OAID/SNOW	Operating	13
L3OVT	StreetCar - Overtime	Operating	4

MCKINDLEY-WARD,

L3OVT	StreetCar - Overtime	Operating	5
L5952	OAID/SNOW	Operating	9

POND III,JOHN A

L5952	OAID/SNOW	Operating	14
-------	-----------	-----------	----

UFA - UFA

Name	Index	TITLE	Type	Total Hours
-------------	--------------	--------------	-------------	--------------------

DUNCAN,LENNITA

L5952	OAID/SNOW	Operating	2
-------	-----------	-----------	---

EUTSLER,EARL C

L5952	OAID/SNOW	Operating	12
-------	-----------	-----------	----

JUST,DANIEL

T4788	TREE PLANTING	Direct	10
K0164	Integrated Pest Management	Direct	8
L5952	OAID/SNOW	Operating	13
L3OVT	StreetCar - Overtime	Operating	4

O'NEILL,JOHN

K0164	Integrated Pest Management	Direct	1
L5952	OAID/SNOW	Operating	13
L3OVT	StreetCar - Overtime	Operating	2

SAUNDERS SR,BARR

L5952	OAID/SNOW	Operating	24
-------	-----------	-----------	----

YTURRALDE,KASEY

K0164	Integrated Pest Management	Direct	10
-------	----------------------------	--------	----

D.C. Department of Transportation: Workers Compensation Payments in FY 2

Workers Compensation	Payment Type			
Fiscal Year	Allocated Loss Expense	Indemnity	Medical	Grand Total
2015	\$2,750.95	\$312,996.34	\$89,489.27	\$405,236.56
2016		\$137,503.35	\$51,612.89	\$189,116.24
Grand Total	\$2,750.95	\$450,499.69	\$141,102.16	\$594,352.80

!015 and FY 2016 (To Date)



DDOT Information Technology Electronic Systems

AASHTOWare

This desktop application is a design system for transportation construction tracking and cost estimates. It helps DDOT in building cost estimates for procurement bidding and managing field operation cost. This application is used by all DOTs in the US and includes several extensions and modules.

- System Age – 11 years
- Last Upgrade – 2014
- Data Available to Public – No

ARCMAP & ArcGIS Online

Software delivering Geographic Information System (GIS) solutions. DDOT is part of the District's Enterprise License Agreement (ELA).

- System Age – 13 years
- Last Upgrade – 2014
- Data Available to Public – Yes
- URL - <https://sp3.ddot.dc.gov/oi/data/DataWiki/Home.aspx>

CaBi Dashboard

This is a web-based solution that provides a CaBi dashboard and publishes over 16 key performance metrics of the Capital Bikeshare program to the public.

- System Age – 9 years
- Last Upgrade – 2014
- Data Available to Public – Yes
- URL - <http://cabidashboard.ddot.dc.gov/CaBiDashboard/#Home>



DDOT Information Technology Electronic Systems

Call Center Console

Call Center Console allows DDOT's Call Center representatives to capture and track internal and external requests (phone calls).

- System Age – 2 year
- Last Upgrade – 2014
- Data Available to Public – No

Call for Projects Intake Form

The "Call for Projects" Intake Form is a web-based application that collects projects and programs for each administration within DDOT to support the project submission process and approval process.

- System Age – 3 years
- Last Upgrade - 2014
- Data Available to Public – No

CapTop

This web-based/GIS centric system is used by DDOT's Traffic Management Center for traffic operation, incident management, traffic data collection, processing, data sharing, and traffic performance evaluations.

- System Age – 4 years
- Last Upgrade – 2014
- Data Available to Public – No

Cityworks

This is a web-based/Commercial of the Shelf (COTS) Work Order Management System DDOT uses to manage over 250K 311 Service Request (SR) each year. This system currently integrates with OUC 311 CSR system.

- System Age – 11 years
- Last Upgrade – 2015
- Data Available to Public – No



DDOT Information Technology Electronic Systems

Circulator Dashboard

This is a web-based solution that provides a Circulator dashboard publishes over 23 key performance metrics of the circulator bus to the public.

- System Age – 5 years
- Last Upgrade – 2014
- Data Available to Public – Yes
- URL - <http://circulatordashboard.dc.gov/cirdashboard/#Home>

Cyclomedia Globespotter

This is a web-based/GIS centric solution used to view panoramic street level imagery collected for the District Government. The system produces Cycloramas (digital, spherical, 360° panoramic images).

- High resolution imagery
 - Well defined internal image geometry
 - Accurate georeference (10 cm) and orientation (0,1°)
 - Complete Metadata
 - All Roads and Alleys were collected
 - Delivery through web hosting or local installation
 - Integrated with ArcGIS and AGO
 - Data Collection Toolbar
 - Measuring tool
- System Age – 2 years
 - Last Upgrade – 2014
 - Data Available to Public – No
 - URL - <https://globespotter.cyclomedia.com/>

DBE

This web-based solution provides the Disadvantage Business Enterprise office a tracking and management tool for Certified Disadvantage Business Entreprises (DBE) performing work with DDOT.

- System Age – 4 years
- Last Upgrade – 2014
- Data Available to Public – No



DDOT Information Technology Electronic Systems

DDOT Public Internet - DDOT's web site for public, communication channel for all DDOT related information for public and private. Content is updated by DDOT's PIO. The Content Management System "Drupal" is maintained by OCTO.

- System Age – 3 years
- Last Upgrade – 2014
- Data Available to Public – Yes
- URL – <http://ddot.dc.gov>

DDOT University

DDOTUniversity, the web based training site to find information on the entire courses DDOT offer and encourage Employee's to participate, both internally and externally. This system allows employees to register for training and the training office to track approval and cost.

- System Age – 5 years
- Last Upgrade – 2014
- Data Available to Public – No

DTAP

District Transportation Access Portal system is used to inform the public of Capital Infrastructure Projects.

- System Age – 6 years
- Last Upgrade – 2014
- Data Available to Public – Yes
- URL - <http://dashboard.ddot.dc.gov/ddotdashboard/#Home>

Electronic Procurement Management System (EPMS)

This web-based SharePoint application allows DDOT to track the status of procurements as they move through the OCP procurement process.

- System Age – 3 years
- Last Upgrade – 2014



DDOT Information Technology Electronic Systems

- Data Available to Public – No

Envista

This SaaS/web-based/GIS centric application enables D.C. and its Utilities to share construction project schedules. The system reports on conflicts, opportunities, and streets protected under the five year moratorium. On a monthly basis, the Top 20 conflicting projects are automatically identified and resolved by project managers.

- System Age – 7 years
- Last Upgrade – 2014
- Data Available to Public – No

E-Time

This web-based application is DDOT's employee time sign-in tracking system to track employee daily tour of duty.

- System Age – 8 years
- Last Upgrade – 2014
- Data Available to Public – No

Facility Mgmt (FM) Service Request

This web-based application is a 'Service Request' tracking system for DDOT's Facility Management team. It allows administrations to request employee relocation moves and other request affiliated with facility.

- System Age – 4 years
- Last Upgrade – 2014
- Data Available to Public – No

HPMS

This is the Highway Performance Monitoring System, a web-based application used by IPMA for managing roadway condition data into the mandated FHWA 2010+ format. It generates accurate reports for annual FHWA submittal.

- System Age – 4 years



DDOT Information Technology Electronic Systems

- Last Upgrade – 2014
- Data Available to Public – Yes
- URL - <http://ddotgisapp02/hpms>

Invoice Tracking System

Infrastructure Project Management Administration (IPMA) Invoice Tracking System, web-based application used to track construction and consultant invoices.

- System Age – 8 years
- Last Upgrade – 2013
- Data Available to Public – No

ITEMS

The Information Technology Equipment Management System is a web-based application used within the IT team as an asset tracking system for DDOT. This system is used to track all computers, monitors, tablets, phones, etc.

- System Age – 2 year
- Last Upgrade – 2014
- Data Available to Public – No

MicroPAVER

This is a desktop pavement management system used to track pavement condition index (PCI) and perform analysis report. DDOT uses this system to prioritize roadways that will be restored or repaved each year.

- System Age – 11 years
- Last Upgrade – 2014
- Data Available to Public – Yes
- URL – FY 12/13 PCI
<http://ddot.in.dc.gov/ddot/cwp/view.asp?a=1229&q=492572>

FY 15 Work Plan (includes link to interactive map)

<http://ddotfiles.com/db/WPFY15Completed/>

Microstation Bentley



DDOT Information Technology Electronic Systems

This desktop Computer Aided Design/Drafting (CAD) software is used by DDOT's engineers for viewing or modifying drawings.

- System Age – 10 years
- Last Upgrade – 2014
- Data Available to Public – No

NHS CCTV

GIS centric application used to monitor Cameras along the National Highway System (NHS) routes.

- System Age – 7 years
- Last Upgrade – 2014
- Data Available to Public – Yes
- URL - http://nhscameras.ddot.dc.gov/NHS_Cameras/

NOI

Notice of Intent, This web-based application provides the public access to “Notice of Intent” for construction projects. In addition to the notice it also provides the public with a way to provide comments.

- System Age – 3 years
- Last Upgrade – 2013
- Data Available to Public – Yes
- URL - <https://noiadmin.hostpilot.com/SitePages/noi.aspx>

NOV System

Notice of Violation System (NOV) is a web based system used by the DDOT Public Space Inspectors (PSI). PSI uses this system to issue, track and enforce respondents suspected of illegally using public space in the District of Columbia. This system allows our PSI office to capture all relevant information concerning the respondent, the date and location of the violation, the violation code and the fine.



DDOT Information Technology Electronic Systems

- System Age – 5 years
- Last Upgrade – 2014
- Data Available to Public – No

OITI Ticket System

This is web-based /SharePoint IT ticketing system is used to support DDOT's internal IT, GIS, Telecom, Network, and Desk support team. It tracks and monitors all IT related service requests.

- System Age – 5 years
- Last Upgrade – 2014
- Data Available to Public – No

Packet Tracker

This web-based system electronically tracks various packets as they move through DDOT for sign-off and approval. This system standardizes approval flows. Provides a document library and allows for packet document attachments.

- System Age – 6 years
- Last Upgrade – 2013
- Data Available to Public – No

Permit Locator Tool

This application gives the public the ability to see active public space permits and applications on an interactive map.

- System Age – 5 years
- Last Upgrade – 2013
- Data Available to Public – Yes
- URL - <http://gis.ddot.dc.gov/PermitLocator/#Home>



DDOT Information Technology Electronic Systems

Permit Viewer

This application gives the public the ability to see active public space permits and applications on an interactive map. This application is available as a web-based system and also available as a mobile app through iOS and Android devices.

- System Age – 3 years
- Last Upgrade – 2014
- Data Available to Public – Yes
- URL -

<http://maps2.dcgis.dc.gov/DCAGOL/basicviewer/?appid=f82726c0a4b545c7bc6779377c44f33c&webmap=b08e4155c7984d2b9d88c96bd2dfd24c>

Temporary Public Space Occupancy Map

This map shows existing construction projects, emergency utility work and special events that may impede on travel time. The icons represent activities temporarily affecting public space, which display various details when selected. For example, public space permit numbers and beginning and end dates for a project or special event. This allows users to examine activities in greater detail.

Data for the map is pulled from [DDOT's Transportation Online Permitting System](#) (TOPS) and ProTrack (DDOT project tracking) databases.

- System Age – 2 years
- Last Upgrade – 2014
- Data Available to Public – Yes
- URL -

<http://maps2.dcgis.dc.gov/DCAGOL/basicviewer/?appid=f82726c0a4b545c7bc6779377c44f33c&webmap=b08e4155c7984d2b9d88c96bd2dfd24c>

Compendium

The web-based SharePoint DDOT Compendium is an online reference that provides comprehensive information about all of DDOT's policies, procedures, and services. The Compendium contains a variety of materials - ranging from regulations, to federal legislation, to transportation studies, to FAQs. It is organized alphabetically, by subject, and contains summary pages that provide links to all related documents and references.



DDOT Information Technology Electronic Systems

According to the District Department of Transportation Policy Compendium Act of 2012 (District Law 19-168):

- “On or before September 30, 2013, the District Department of Transportation shall prepare a policy compendium listing all of the agency’s policies and procedures that affect the management of the transportation network and public space...”
- “The District Department of Transportation shall make the policy compendium available online...”

The Compendium complements the innovative online resources already provided by DDOT and the District government, such as DDOT's website (www.ddot.dc.gov) for current department news and projects, DDOT's Transportation Online Permitting System (TOPS) for processing public space applications and permits, and 311 Online for accessing city service requests.

- System Age – 5 years
- Last Upgrade – 2013
- Data Available to Public – Yes
- <http://comp.ddot.dc.gov/SitePages/Home.aspx>

Pontis

This web-based application is used by DDOT’s Infrastructure Project Management Administration as a Bridge Management Software, tracking yearly Bridge maintenance records on DC bridges.

- System Age – 8 years
- Last Upgrade – 2014
- Data Available to Public – No
- URL - <http://10.83.49.153/BrM521/DesktopDefault.aspx?ReturnUrl=%2fBrM521>

PROMPT

This web-based Project Management Performance Tool (PROMPT) 2.0 PROMPT provides DDOT’s project managers and executive team with project financial and obligation information.

All active projects must be updated in PROMPT monthly:

- Project Status
- Milestone Dates, Planned and Actual Milestone Dates
- General Information: Verify that the description, scope, project manager, etc. are current
- Payroll Spending: Make sure that the correct employees are charging to the correct project



DDOT Information Technology Electronic Systems

- Funding Availability by Phase: Check that there are sufficient funds available in each active project phase in order to avoid going into anti-deficiency.
- System Age – 8 years
- Last Upgrade – 2014
- Data Available to Public – No

Protrack

This web-based GIS centric application captures the geographic extent of all roadway projects. In addition it captures the phase, status, and completion date. This system is also used to monitor streets protected under the District's five year moratorium for newly paved roads.

- System Age – 9 years
- Last Upgrade – 2015
- Data Available to Public – Yes
- URL - <http://sddotgissvr/ProTrack/Login.aspx>

QA/QC Management System

This is a web-based system designed for DDOT's Infrastructure Project Management Administration to manage data at the McMillan Dr Material Lab. This system is used to perform testing and ensure Quality Assurance and Quality Control (QA/QC) of all approved material to be used in roadway and sidewalk construction by DDOT's contractors.

- System Age – 9 years
- Last Upgrade – 2015
- Data Available to Public – No

Rapid plan

Rapid Plan is a desktop application used by DDOT's Traffic Work Zone Technicians to develop Traffic Control Plans (TCPs).

- System Age – 5 years
- Last Upgrade – 2015
- Data Available to Public – No



DDOT Information Technology Electronic Systems

Road Care

This is a web-based system used to track pavement condition through the use of roadway video log.

- System Age – 3 years
- Last Upgrade – 2014
- Data Available to Public – No

RideDC

The RideDC Portal Dashboard was conceptualized to provide DC retail establishments and organizations with a web-based tool that would allow users to easily create their own “custom” dashboard to display a dynamic map of transit options near their establishment. The RideDC Portal Dashboard provides near real-time information about multi-modal transportation options and locations on the map. The portal displays:

- Metro Bus / DC Circulator schedules and Nextbus updates
- Metrorail arrival predictions
- Capital Bikeshare bike and open dock availability
- Caresharing location and car availability

The custom dashboard are expected to be display on a monitor near the exit of the retail establishment or somewhere easily accessible to visitors of the establishments, offering the clients near real-time transportation options for their next destination.

- System Age – 2 year
- Last Upgrade – 2014
- Data Available to Public – Yes
- URL - <http://ridedc.ddot.dc.gov/>

Sharepoint 2010 and 2013

This Microsoft web-based solution is used for internal collaborations, conference room reservation, leave calendar, projects and so on with added features in Microsoft products.

- System Age – 7 years



DDOT Information Technology Electronic Systems

- Last Upgrade – 2014
- Data Available to Public – No

Sidewalk Cafe Inspection System

This web-based GIS centric system is used by DDOT's Public Space Inspectors to perform detailed inspections of each sidewalk café in the District. Information contained in this system includes but is not limited to Certificate of Occupancy, dimensions of Sidewalk Café, number of ADA tables, number of chairs, etc.

- System Age – 2 years
- Last Upgrade – 2013
- Data Available to Public – Yes
- URL - <https://sp.ddot.dc.gov/SitePages/Home.aspx>

SIS

This web-based GIS solution provides users with information on the Street Inventory System. Information contained in this system but limited to is number of lanes, routes, pavement condition, pavement type, etc.

- System Age – 9 years
- Last Upgrade – 2008
- Data Available to Public – No

Snow AVL – This Automated Vehicle Locator (AVL) is a web-based GIS centric application used during snow and ice removal operations to track snow plow vehicles and their current activity.

- System Age – 7 years
- Last Upgrade - 2014
- Available to Public – Yes
- URL - <http://dc.eroadtrack.com/login.aspx>

SSD

Street Spatial Database (SSD) is a web-based GIS centric application used to maintain the District's street network and provides a computerized base roadway network. The street centerlines polyline GIS



DDOT Information Technology Electronic Systems

dataset is the keystone data item for DDOT's Linear Referencing System. Many of DDOT's data and business systems are already integrated and/or associated with the centerline/LRS; the plan moving forward is to have all assets associated for ease of maintenance and analysis.

- System Age – 9 years
- Last Upgrade – 2014
- Data Available to Public – Yes
- URL - General Public:

http://opendata.dc.gov/datasets/99d13287b85240b89bd46b2aa89e1acf_41

- URL - GIS Web Service:

<http://maps2.dcgis.dc.gov/dcgis/rest/services/DDOT/SSD/MapServer>

StormTrak

StormTrak is a web-based application used during snow and storm events to track labor and material cost for DDOT and DPW.

- System Age – 3 years
- Last Upgrade – 2014
- Data Available to Public – No

TIES

The Transportation Integrated Enterprise Solution (TIES) is a framework developed on the ArcGIS platform and integrated with ArcGIS Online as a geospatial frame work to tie each disparate system together using location as the common denominator. The resulting Service Oriented Architecture (SOA) supports a user driven analytical dashboard providing managers and decision makers access to information resulting in increased knowledge across the enterprise; thus increasing services to constituents while reducing cost.

- System Age – 3 years
- Last Upgrade – 2014
- Data Available to Public – Yes



DDOT Information Technology Electronic Systems

- URL - <http://maps2.dcgis.dc.gov/dcgis/rest/services/DDOT>

TRAKA

Traka (To Track A Key Asset) provides intelligent key access control for fleet management at DDOT. This solution includes hardware and software. TRAKA key lockers are currently installed at five DDOT locations (offices).

- System Age – 4 years
- Last Upgrade – 2014
- Data Available to Public – No

Tree Permit System

This web-based system is used by Urban Forestry Administration (UFA) for Special Tree Removal. The system allows the public to apply to have a tree removed on private property that is hazardous, ill, or due to construction. UFA uses the system to track of Tree inventory on private property and issue the permit. This system is a component of the TOPS permitting system.

- System Age – 4 years
- Last Upgrade – 2014
- Data Available to Public – Yes
- URL – <https://tops.ddot.dc.gov>

TOPS

This web-based application is the District Department of Transportation's Online Permitting System (TOPS) that allows you to apply for a Public Space Occupancy, Construction, Excavation or Annual Rental Permit required for use of public space within the District of Columbia. You can be a home owner, tenant, or business needing to occupy metered or unmetered curbside parking, sidewalk, alley or travel lane areas for your activity or construction related work. Once registered, the system makes it easy for you to log into your account any time to apply for a permit, edit your application, upload plans electronically, or check the status of your application. TOPS even allows you to pay for the permit online and then print your permit and reserved parking or emergency not parking signs at any of the DDOT kiosks. The DDOT kiosks are conveniently located at the local 2nd, 3rd, 4th, 5th, 6th, 7th Metropolitan Police Department District offices and our DDOT Public Space Permit Office at 1100 4th Street SW.



DDOT Information Technology Electronic Systems

- System Age – 7 years
- Last Upgrade – 2014
- Data Available to Public – Yes
- URL – <https://tops.ddot.dc.gov>

Vendor Point Picker

The Street Vendor Point Pick application is a web-based GIS centric system to verify vending locations in the District that aids in the street vendor approval and inspection process by leveraging GIS to receive specific XY coordinates and exact locations. Street Vendor Point Pick application provides customers a means to select a prospective location for street vending based on dropping a point on a GIS centric map. Through a spatial query, the map will zoom to the block to verify the location and its availability. This system is used by DCRA and DDOT.

- System Age – 3 years
- Last Upgrade – 2014
- Data Available to Public – Yes
- URL – <https://streetvendor.ddot.dc.gov/StreetVendor/#>

Visitor Parking Pass

This web-based application is DDOT's Visitor Parking Pass (VPP), Online system that allows residents to apply and request a VPP pass. The system prints and issues passes to eligible District household on a Residential Parking Permit (RPP) zoned blocks in District.

- System Age – 3 years
- Last Upgrade – 2014
- Data Available to Public – Yes
- URL – <https://vpp.ddot.dc.gov>

Fleet

DDOT uses a Fleet Management database management system. The agency records, maintains, and manages its fleet using this information, which includes activities such as Registration, Inspection, Infraction, Trip Information, and Maintenance.



DDOT Information Technology Electronic Systems

- System Age – 2 Months
- Last Upgrade – December 2015
- Data Available to Public – No

FLMA

DDOT uses the Family Leave Recording System to track and manage employee leave. This includes information about leave (FMLA/PFL/Federal FMLA) requested by an employee and whether leave was approved, deferred, or rejected.

- System Age – 1 Month
- Last Upgrade – January 2016
- Data Available to Public – No

Visitor Parking Pass

This web-based application is DDOT's Visitor Parking Pass (VPP), Online system that allows residents to apply and request a VPP pass. The system prints and issues passes to eligible District household on a Residential Parking Permit (RPP) zoned blocks in District.

- System Age – 3 years
- Last Upgrade – 2014
- Data Available to Public – Yes
- URL – <https://vpp.ddot.dc.gov>



FY 2015 Performance Accountability Report District Department of Transportation

INTRODUCTION

The Performance Accountability Report (PAR) measures each agency's performance for the fiscal year against the agency's performance plan and includes major accomplishments, updates on initiatives' progress and key performance indicators (KPIs).

MISSION

The District Department of Transportation's (DDOT) mission is to enhance the quality of life for District residents and visitors by ensuring that people and goods move safely with minimal adverse impact on residents and the environment.

SUMMARY OF SERVICES

DDOT executes its mission through the work of the following divisions:

The Infrastructure Project Management Administration designs and builds roads, bridges, rails and other transportation infrastructure projects; the Progressive Transportation Services Administration provides public transportation service through Metro and the Circulator bus system; the Transportation Operations Administration ensures a safe and user-friendly transportation environment; the Planning, Policy and Sustainability Administration develops strategic goals for the agency; the Public Space Regulation Administration regulates the safe and efficient use of the public space for various public and private uses; the Urban Forestry Administration maintains the District's street trees, providing our community with traffic calming, improved air quality, increased ground water retention that minimizes runoff and flooding, temperature moderation, and aesthetics.

OVERVIEW – AGENCY PERFORMANCE

The following section provides a summary of DDOT performance in FY 2015 by listing DDOT's top three accomplishments, and a summary of its progress achieving its initiatives and progress on key performance indicators.

TOP THREE ACCOMPLISHMENTS

The top three accomplishments of DDOT in FY 2015 are as follows:

Accomplishment One

Kids Ride Free

Progressive Transportation Services Administration (PTSA)



Objective 1 Increase and Promote mass transportation modes to meet the mobility and economic development needs of the District.

Initiative 1.2 Implement the Metrobus free student transportation program

The School Transit Subsidy Program offers free or reduced fares for District students who use Metrobus, Metrorail, or the DC Circulator to travel to and from school and school-related activities. DDOT, with the assistance of OCTO and WMATA, successfully rolled out the Kids Ride Free on Bus student pass at the start of the 2014-2015 school year. Students were successfully able to ride Metrobus and the DC Circulator to school for free using their DC One Cards. On June 30, 2015, the D.C. Council authorized Mayor Bowser's proposed expansion of the Kids Ride Free program to include Metrorail. DDOT, WMATA, OCTO, and the Deputy Mayor for Education coordinated to implement this expanded program. In August 2015, students were eligible to go online and enroll in both programs using their DC One. As of the end of FY15, approximately 13,000 students enrolled in the Kids Ride Free program and have taken more than over 5,700 trips on rail.

Accomplishment Two

Optimize Traffic Signals

Transportation Operations Administration (TOA)

Objective 1 Ensure that the District's current transportation assets (traffic signals, parking meters, streetlights) are in good working condition and utilized at their optimal capacity.

Initiative 1.2 Optimize traffic signals (Sustainable DC Plan Transportation Action 2.5)

To accommodate the significant development activity within the District and the new traffic signals and changing of travel patterns associated with the development, DDOT is working to optimize traffic signals throughout the District. The goal is to improve overall traffic flow, optimize pedestrian crossing times, and reduce bus-running times. In FY15, DDOT completed Phase Two of this five-year project (optimizing all 1,600 plus traffic signals). Specifically, Phase Two included the optimization of approximately 635 signals, which resulted in network-wide travel-time savings of 15.6% for passenger cars and 5% for buses. The signals optimized during Phase II were located in and around the downtown area between Rock Creek Parkway in the west, North Capitol in the east, U Street/Florida Avenue in the north, and I-395 in the south. The optimized area also includes a few intersections in Georgetown area along M St, NW.

Accomplishment Three

AlleyPalooza

Infrastructure Project Management Administration (IPMA)

Objective 1 Preservation of existing transportation infrastructure assets to maintain and improve



condition rating in a cost effective manner

Initiative 1.1 Preserve District roadways

The District provides targeted, expedited alley maintenance services for the residents of the District of Columbia, including roadways and connected alleys. In FY15, DC launched the first ever AlleyPalooza campaign. Over an 8-week period (July 8 - September 11), DDOT repaired or reconstructed 8 alleys in each of 8 Wards. The goal of this program is to complete work on 64 alleys. This is a core activity for the DDOT, involving a broad scope of work ranging from everyday maintenance, such as pothole repair, to the complete reconstruction or rehabilitation of an alley. The District's alleys are a vital, yet often overlooked piece of our City's infrastructure and provide convenience access points to buildings, garages, garbage pick-up, and loading docks. Mayor Bowser has invested \$175 million over the next 6 years in the District's local infrastructure, roads, alleys and sidewalks.

SUMMARY OF PROGRESS TOWARD COMPLETING FY 2015 INITIATIVES AND PROGRESS ON KEY PERFORMANCE INDICATORS

Table 1 (see below) shows the overall progress the DDOT made on completing its initiatives, and how overall progress is being made on achieving the agency's objectives, as measured by their key performance indicators.

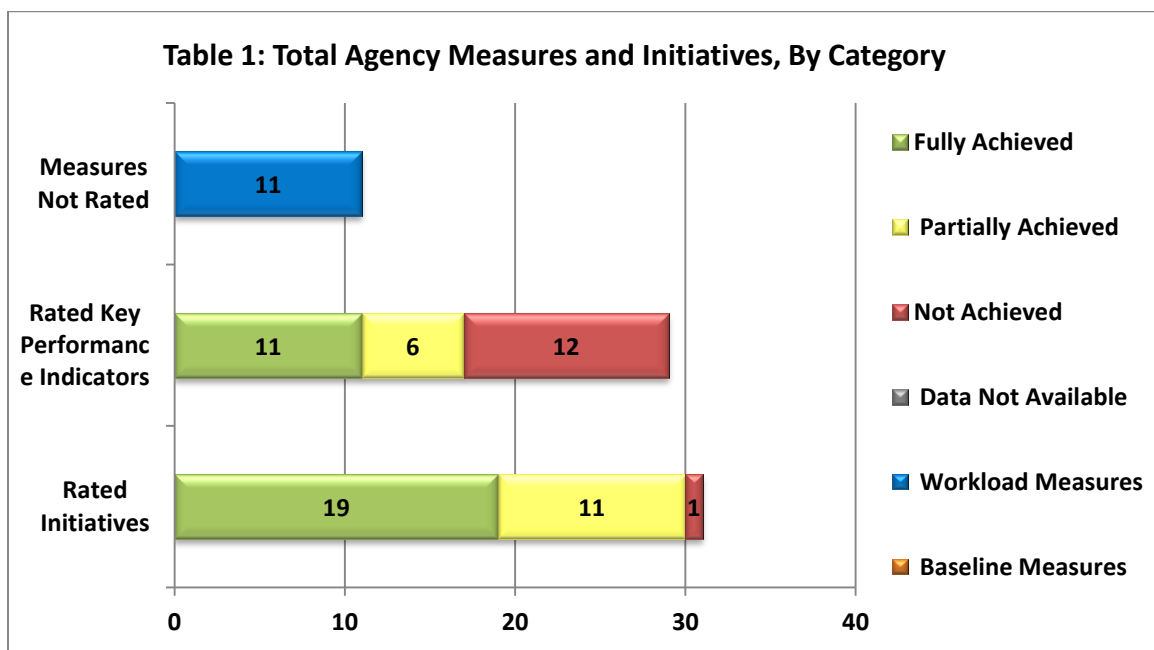

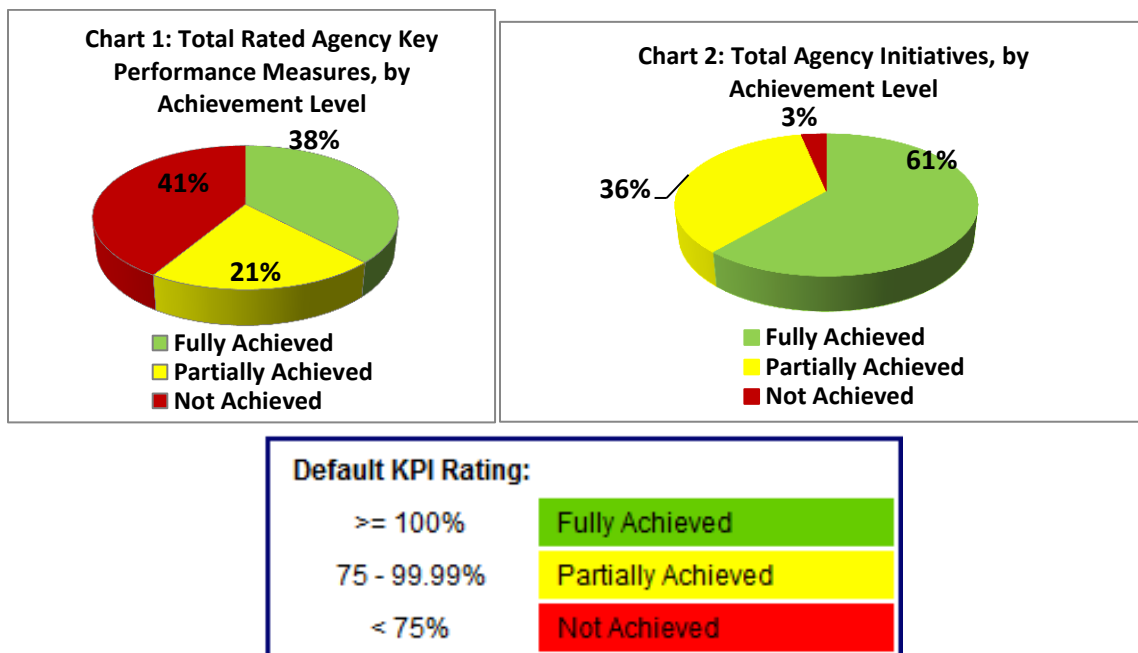

In FY 2015, DDOT fully achieved almost two thirds of its initiatives and nearly 40 percent of its rated key performance measures. **Table 1** provides a breakdown of the total number of performance metrics DDOT uses, including key performance indicators and workload measures, initiatives, and whether or not some of those items were achieved, partially achieved or not achieved. **Chart 1** displays the overall progress is being made on achieving DDOT’s objectives, as measured by their rated key performance indicators. Please note that chart 2 contains only rated performance measures. Rated performance measures do not include measures where data is not available, workload measures or baseline measures. **Chart 2** displays the overall progress DDOT made on completing its initiatives, by level of achievement.

PERFORMANCE INITIATIVES – ASSESSMENT DETAILS

Urban Forestry Administration (UFA)

OBJECTIVE 1: Increase the number and improve the health of street trees in order to provide District neighborhoods with a healthy urban tree canopy (Sustainable DC Plan Nature Action 2.1).

INITIATIVE 1.1: Track the street tree mortality.

UFA will embark on tracking tree mortality related to the street tree planting program. The tree mortality rate will allow UFA to ensure that we understand the losses to the street tree canopy over time. The information will assist UFA with the planning of the tree planting needs within the District and ensure we remain on track to accomplish the 40% canopy goal



by 2032 as outlined in the District's Sustainable DC Plan and Urban Tree Canopy Plan.
Completion Date: September 30, 2015.

● **Performance Assessment Key: Fully Achieved**

UFA is tracking tree mortality rate for street tree planting and developed a working group to create a standard operating procedure for tracking mortality. In FY 15, the mortality rate for UFA street trees was 1.63%. UFA continues to track the overall mortality rate with the street tree population to ensure our planting program covers the loss but provides the gain needed to achieve the 40% canopy goal by 2032.

INITIATIVE 1.2: Increase tree species diversity planted in public space (Sustainable DC Plan Nature Action 2.1, 2.5; and Water Action 2.2).

● **Performance Assessment Key: Fully Achieved**

UFA continues to look for new varieties of trees and cultivars that thrive successfully in the urban environment. As these species are identified, UFA adds these names to the planting list and works closely with the contractor to procure them. When they are not available, UFA looks for similar replacements or takes the suggestion from the nursery grower. Last year, the city planted nearly 130 different species and cultivars, with an even greater diversity planned for FY16. Through a process of rigorous tree inventory analysis, UFA has identified those species that occur in an overabundance and have adjusted the planting list to reflect a balance amongst the different plant species

INITIATIVE 1.3: Inspect green infrastructure sites within the right-of-way to ensure that these sites are operational, plant material is alive and invasive species are removed.

This initiative will ensure that we remain compliant with our MS4 permit and are improving water quality. These sites range from small green spaces that are depressions allowing water to percolate to medium size green spaces that have drainage being routed from the site to large retention ponds that have trash grates and large landscaped berms. **Completion Date: September 30, 2015.**

● **Performance Assessment Key: Fully Achieved**

UFA has mapped most of the Low Impact Development sites citywide that are under DDOT's jurisdiction. With this information, UFA has created a map and inventory of these sites for all to view. UFA staff performs inspections throughout the year to ensure that the sites are functioning. UFA has formed a working group to continue this process with tracking and development of inventories for green infrastructure.







INITIATIVE 1.4: Maintain beehives on public spaces throughout the District through the use of swarm capturing techniques as available (Sustainable DC Plan Food Action 1.4).

This initiative will help with the pollination of trees and plants citywide and meet the goals of Sustainable DC. Many are located in community gardens (Mclean Gardens, Wangari Gardens and Alger Park) and on sites with partners like Earth Conservation Corps. All honey production will be given to local food pantries. **Completion Date: September 30, 2015.**

● Performance Assessment Key: Fully Achieved

Maintenance of beehives on public space will support the pollination of trees and plants citywide and the goals of Sustainable DC. UFA will collaborate with DS to examine other ways to incorporate food-producing landscapes into public space. UFA has 7 hives in production throughout the city. Many are located in community gardens (Mclean Gardens, Wangari Gardens and Alger Park) and on sites with partners like Earth Conservation Corporation

KEY PERFORMANCE INDICATORS– Urban Forestry Administration

	KPI	Measure	FY 2014 YE Actual	FY 2015 YE Target	FY 2015 YE Revised Target	FY 2015 YE Actual (KPI Tracker)	FY 2015 YE Rating (KPI Tracker)	Budget Program (KPI Tracker)
	1.1	Percent of street tree population inspected	29%	29.5%		28.3%	98.02%	Urban Forestry Administration
	1.2	Percent of green infrastructure sites inspected	90%	91%		88.4%	97.1%	Urban Forestry Administration
	1.3	Number of trees planted Citywide (Sustainable DC Nature Goal 2)	8,600	8,600		8635	100.41%	Urban Forestry Administration
	1.4	Percent of street trees in a healthy	97.9%	97%		95.84%	98.80%	Urban Forestry Administration



		condition						
●	1.5	Street tree mortality rate	2.03%	7.5%		1.63%	1846.64%	Urban Forestry Administration

Infrastructure Project Management Administration (IPMA)

OBJECTIVE 1: Preservation of existing transportation infrastructure assets to maintain and improve condition rating in a cost effective manner.

INITIATIVE 1.1: Preserve District roadways.

The pavement management program is a planned strategy of cost effective treatments to improve and maintain the District of Columbia's roadway network system. The local paving work plan includes various pavement treatments such as milling and resurfacing, slurry seal, deep patching and crack sealing. The plan for the federal roadway network will include a variety of treatments similar to local streets. After the treatments are applied, those segments of pavement will experience an increase in the average pavement condition index from a poor/very poor rating to good/excellent rating. The segments are selected based on pavement condition data that indicates the condition of the roads. The FY 15 budget for paving is approximately \$18.5 million. **Completion Date: December 30, 2015.**

● **Performance Assessment Key: Fully Achieved**

The Pavement Management Program (PMP) is working to complete the goal of preserving the District's roadways. Federally and locally funded contracts are in place to provide strategic pavement treatments to improve the average pavement condition indices. The PMP is deploying many solutions to help management the roadways throughout the District such as slurry seal, creak sealing, and general resurfacing to help extend the life of the asset.

INITIATIVE 1.2: Preserve District bridges.

The bridge asset management program includes maintaining inventory of structures; performing biennial National Bridge Inventory (NBI) and element level inspection; condition assessment and load ratings of all structures; and implementing bridge preservation actions that are intended to address bridges while they are still in good or fair condition. Bridge preservation activities will be performed based on prioritization of structures as part of the overall preservation program. Some repair activities require design. The FY15 bridge preservation program cost is approximately \$8 million. **Completion Date: September 30, 2015.**

● **Performance Assessment Key: Fully Achieved**



The Bridge Asset Management Program is working to preserve the District's bridges. Federally funded contracts are in place to inspect, assess, and repair bridges in our inventory as part of a bridge preservation program.

INITIATIVE 1.3: Preserve District tunnels.

The tunnel management system allows DDOT to update and maintain condition data of the various tunnel assets within the District. DDOT manages a citywide performance based tunnel contract, which contains asset inventory and performance measures for the mechanical, electrical, structural, and lighting assets within the tunnels. Assets will receive preventive maintenance based on established standards to maintain an accepted level of service. Additionally, engineering design for an emergency communication system within the mall tunnel to further improves emergency response and safety needs will be completed. The FY15 associated construction cost is approximately \$6 million. **Completion Date: September 30, 2015.**

● **Performance Assessment Key: Fully Achieved**

The Tunnel Management System is working to update and maintain the District's tunnels. The citywide performance-based tunnel contract provides for preventative maintenance as well as state of good repair for mechanical, structural, lighting and lighting assets within the tunnels. The Federally funded contract to support this activity is in place.

OBJECTIVE 2: Incorporate into the infrastructure design sustainability, multimodal, historic preservation and low impact elements. (Sustainable DC Plan Water Action 2.2; and Transportation Action 2.1).

INITIATIVE 2.1: Expand the South Capitol Street Bike Trail (Sustainable DC Plan Nature Action 3.2; and Transportation Action 2.1).

The project is part of a continuing effort to expand multi modal transportation options and connect the District to regional multi-use trail systems. It consists of the preliminary design of 4.25 miles of a new bicycle/multi use trail on the west side of South Capitol Street from the intersection of Firth Sterling Avenue to the Oxon Run trail in Southeast DC. This new trial section will be a vital link allowing District residents to access major trail systems within Maryland and Virginia (and vice versa) and will supplement commuting options for employees of the Coast Guard Headquarters and Department of Homeland Security facilities at St. Elizabeth's West Campus as well as Joint Base Anacostia Bolling (JBAB) facilities. The trail will be lighted, landscaped and feature safe new crossings and bicycle/pedestrian signals at the major entrances to JBAB and at cross roads. **Preliminary Design Completion Date: April 30, 2015.**

● **Performance Assessment Key: Fully Achieved**



The staff working within the IPMA division completed the Preliminary Design by April 30, 2015.

INITIATIVE 2.2: Preserve the Francis Scott Key Bridge.

The project calls for the rehabilitation/preservation of the historic Francis Scott Key Bridge, a District landmark and one of the most picturesque bridges on the Potomac River. The Key Bridge is an eight span reinforced concrete open spandrel arch bridge that carries six lanes of two-way traffic between Northern Virginia and the District of Columbia over the C&O Canal, the Whitehurst Freeway, K Street, the Potomac River, and the George Washington Parkway. The bridge was originally constructed in 1925 and was rehabilitated in 1986 with a new deck. The bridge has a total length of 1781'-8", an out-to-out deck width of 90'-0" and a curb-to-curb width of 66'-0". All work on the bridge and roadways will be performed within the existing right-of-way. The scope of the rehabilitation work includes the repair of superstructure and substructure concrete, strengthening of areas of the bridge deck, maintenance of traffic, replacement of streetlights, installation of decorative and accent lighting for the bridge arches, clean and painting bridge railings and steel appurtenances, cleaning and repairing the bridge drainage system, repair of utility supports, and installation of bicycle activated flashers and signage at the ramp to Whitehurst Freeway. The final scope of work will include all rehabilitation necessary to maintain the current level of service for 30 years. The construction cost is estimated in the \$15 to \$20 million range. **Design Completion Date: March 31, 2015**

● **Performance Assessment Key: Partially Achieved**

The construction contract for the Rehabilitation of the Key Bridge over Potomac River is presently being advertised and will have a bid opening on December 9, 2015. The award will follow with tentative notice to proceed in April 2018.

INITIATIVE 2.3 Minnesota Avenue Streetscape (Sustainable DC Plan Energy Action 1.3, Transportation Action 2.5, Water Action 2.2 & Power Undergrounding Age-Friendly DC Goal: Domain # 2).

The Minnesota Avenue Streetscape project will be focused on safety improvements and sustainability. Phase I of the project is from A Street SE to 100' feet north of Dix Street NE. The project will incorporate traffic calming measures as part of the overall design including high visibility crosswalks and new curb extensions, which promote pedestrian safety by reducing crossing distances at crosswalks. The project will also replace wheelchair ramps to meet the latest ADA guidelines. Traffic signals and streetlights will be upgraded including a new traffic signal to be installed at the Minnesota Avenue/Blain Street intersection. Catch basins will be replaced to improve drainage. The number of tree and planter boxes will be increased along the corridor to reduce storm water runoff. Some tree boxes will be continuous with structural soil added to sections below the sidewalk for better water absorption and tree root expansions. Bio-retention planters will also be incorporated.









Redundant driveways will be consolidated along with other driveways relocated to allow installation of clear pedestrian path. Environmentally friendly LED lights that consume 50% less electricity and have a life span of 15 years will be installed as part of the project. The project will also include underground power line infrastructure that will be utilized by electric company for the purpose of undergrounding existing overhead primary power lines. Total cost of this federally participating project is \$18 million. **Completion date: November 30, 2015**

 **Performance Assessment Key: Partially Achieved**

Phase I of the Minnesota Ave. Streetscape project is presently under construction. The total project cost (Construction + Construction Management) is \$14.7M. Notice to proceed was given on August 10, 2015, and the total construction duration will 18 months for a target completion of February 2017. Currently, the project is 15.5% complete.

KEY PERFORMANCE INDICATORS– Infrastructure Project Management Administration

	KPI	Measure	FY 2014 YE Actual	FY 2015 YE Target	FY 2015 YE Revised Target	FY 2015 YE Actual	FY 2015 YE Rating	Budget Program
	1.1	Percent of blocks in paving plan completed	87.7%	90%		37.03%	41.14%	Infrastructure Project Management Administration
	1.2	Percent of streets in "Fair to Excellent" condition	80.75%	78%		80.12%	102.72%	Infrastructure Project Management Administration
	1.3	Number of structurally deficient bridges	11	10		5	200%	Infrastructure Project Management Administration
	1.4	Percent of sidewalks in plan completed	127.27%	90%		24.51%	27.24%	Infrastructure Project Management Administration
	1.5	Percent of current year projects completed within 10% of budget (except for those with	100%	95%		48.39%	50.93%	Infrastructure Project Management Administration



		scope change)						
●	1.6	Percent of current year projects completed within 60 days of planned end date (except for those with scope change)	100%	95%		37.10%	39.05%	Infrastructure Project Management Administration

Progressive Transportation Services Administration (PTSA)

OBJECTIVE 1: Increase and promote mass transportation modes to meet the mobility and economic development needs of the District.

INITIATIVE 1.1: Construct and launch streetcar service on H Street/Benning corridor (Sustainable DC Plan Transportation Action 1.1). Plan and coordinate future streetcar system expansion beyond H/Benning corridor.

DDOT will complete the design-build effort, which includes installation of traction power system and construction of the multi-use Car Barn and Training Center (Phase I). The streetcar operator, a contracted service, is under contract and on schedule to initiate the streetcar revenue service operation. Revenue service is scheduled to launch by December 30, 2014. Completion Date: December 30, 2014.

DDOT will complete the DC Streetcar System Plan (2014 update), based on recommendations of moveDC, it is a technical update to the DC’s Transit Future System Plan (2010). It will be the new guiding document to direct development and DC Streetcar staging, to provide “Big Picture” conceptual planning for the DC Streetcar program at a system level, and to identify corridors based on mobility and transit needs and economic development potentials. Completion Date: December 1, 2014.

DDOT will update the DC Streetcar Design Criteria to incorporate new and up-to-date information, standard and industry practice based on the latest development in DC Streetcar programs. **Completion Date: September 30, 2015.**

● **Performance Assessment Key: Partially Achieved**

DDOT will complete the design-build effort, which includes installation of traction power system and construction of the multi-use Car Barn and Training Center (Phase I). The



streetcar operator is under contract and on schedule to initiate the streetcar revenue service operation.

DDOT completed a top-to-bottom review of the streetcar program in spring 2015. This review concluded that the District should prioritize investment in the East-West corridor extending the H/Benning Line to the east as far as Benning Road Metro Station and to the west as far as Georgetown. The review also concluded that DDOT should focus on improving the project delivery process for transit projects and utilizes investments in streetcar to improve the speed and reliability of the transit system. Planning for both extensions continued in FY15 with Environmental Assessments in process.

DDOT will update the DC Streetcar Design Criteria to incorporate new and up-to-date information, standard and industry practice based on the latest development in DC Streetcar programs. DDOT is currently examining the status of streetcar technology as our future needs require a solution where power is supplied by methods other than overhead contact wire systems. As we move towards the procurement of additional vehicles, our design criteria and specifications will be developed to meet the latest developments.

INITIATIVE 1.2: Implement the Metrobus free student transportation program.

During FY 15, DDOT, in partnership with WMATA, will continue to promote the Kids Ride Free on Bus program through an enhanced comprehensive outreach strategy through social media and direct contact with schools, students, parents and bus operators. In conjunction with this effort, WMATA will require students tap their student DC One Card on the farebox Smartrip target each time they board the bus using a free bus pass that is uploaded to eligible student's cards. This requirement will allow Metro and DDOT to track student ridership more efficiently and curtail the number of unauthorized users participating in the program.

With the majority of District schools on the DC One Cards, students will be required to use their individual DC One Card to access the program during the school year. Nonetheless, DDOT and WMATA will continue to work together to inform students about the importance of obtaining a DC One Card and will work with the schools to assist them with the implementation of this policy. **Completion Date: September 30, 2015.**

 **Performance Assessment Key: Fully Achieved**

DDOT, with the assistance of OCTO and WMATA, successfully rolled out the Kids Ride Free on Bus student pass at the start of the 2014-2015 school year. Students were successfully able to ride Metrobus and the DC Circulator to school for free by flashing their DC One Cards. Beginning with the second semester DDOT, OCTO and WMATA rolled out the Kids Ride Free on Bus electronic pass. To use the new electronic bus pass, eligible students had to register and download the pass on-line. While technically successful, DDOT and WMATA had some difficulty in convincing students to download the pass and transition from flashing the pass to



tapping the pass on the bus farebox. With the introduction of Kids Ride Free on Rail in the fall of 2015, the electronic rail pass was combined with the bus pass. DC One Card registration has increased and nearly 13,000 students have downloaded the bus pass. With DC One card faregate tapping required to enter the rail system, tapping on bus fareboxes has steadily increased and currently students are tapping their farecards at the bus farebox to use Kids Ride Free on Bus. WMATA, DDOT, and the Office of the Deputy Mayor for Education continue to undertake outreach to students on the need to tap their DC One Cards on the farebox to use their Kids Ride Free on Bus privileges. DDOT will continue this effort in fiscal year 2016.





INITIATIVE 1.3: Implement Circulator expansion plan for new routes and route extensions beginning in FY15 (Sustainable DC Plan Nature Actions 3.4; and Transportation Action 1.2, Age-Friendly DC Goal: Domain # 2).

During FY15, DDOT will undertake a number of actions to implement Circulator route extensions and introduce a new Circulator route on the National Mall. Those actions include procuring 13 new buses to support this service and expand the Circulator fleet. (these buses will arrive early in the second quarter of FY15), completing a MOA on cost-sharing and other matters for the National Mall route with the National Park Service; working with WMATA to prepare a new RFP for operation and maintenance of the Circulator bus system that will be finalized in FY15. **Completion Date: September 30, 2015.**

 **Performance Assessment Key: Partially Achieved**

In FY 2015, DDOT procured 18 new buses to enable the start of service on the National Mall route and to meet the vehicle requirements of other routes in the DC Circulator network. Service began on the National Mall route on June 14, 2015 with a ribbon-cutting ceremony. The additional buses procured in FY 2015 have not been available for the extensions due to the unexpected failure of some of the oldest vehicles in the fleet. In order to provide adequate service levels on the current routes, expansion buses were repurposed to replace the failing buses. Due to the time required to manufacture buses, DDOT expects additional buses to be available to implement extensions during FY 2017.

KEY PERFORMANCE INDICATORS– Progressive Transportation Services Administration

   	KPI	Measure	FY 2014 YE Actual	FY 2015 YE Target	FY 2015 YE Revised Target	FY 2015 YE Actual	FY 2015 YE Rating	Budget Program
	1.1	Farebox Recovery Ratio	18.05%	20.29%		17.04%	84%	Progressive Transportation Services



●	1.2	Total Circulator riders	7,613,639	7,517,890		3,773,727	50.20%	Progressive Transportation Services
	1.3	Subsidy per Circulator rider	\$2.83	\$2.54		\$12.36	N/A – None Listed	Progressive Transportation Services

Planning, Policy and Sustainability Administration (PPSA)

OBJECTIVE 1: Comprehensive and integrated transportation planning.

INITIATIVE 1.1: Continue Implementation of the moveDC Plan (Sustainable DC Plan Climate and Environment Action 2.4, Nature Action 3.1; and Transportation Actions 1.3, 1.4, 3.5, Age-Friendly DC Goal: Domain # 2).

The moveDC Plan outlines a transportation vision through 2040 to accommodate growth, improve safety, and increase transportation options in the District. The final plan will include an Action Plan that outlines two years of priorities as well as mid- and long-term actions to implement the plan. The plan includes green initiatives, parking management, evacuation planning and routing, and the use of Intelligent Transportation Systems; all aimed at finding innovative and effective ways to move people and goods. moveDC incorporates opportunities for climate adaptation and long term sustainable funding into final outcomes of the plan as a part of Sustainable DC goals. Initiating the implementation process will include policy, programmatic, and infrastructure initiatives. **Completion Date: September 30, 2015.**

● **Performance Assessment Key: Fully Achieved**

The moveDC Plan was completed in October 2014 and included a two-year action plan with 36 initiatives. During FY15, DDOT began work on 31 of the initiatives, including advancing critical safety improvements, State of Good Repair projects, and initiating projects to implement transit priority treatments and better bicycle infrastructure. DDOT is on track to implement the 36 initiatives and advance other priorities in the plan.

Initiative 1.2: Initiate the 16th Street Transit Priority Study (Sustainable DC Plan Transportation Action 1.3).

The 16th Street corridor has been identified as a transit priority corridor in moveDC and has been the focus of community advocacy. DDOT will conduct a planning study and community engagement to determine the appropriate approach to transit improvements in the corridor, in order to improve transit performance and efficiency, increase transit ridership, and increase overall person-carrying capacity of the transportation system.

Completion Date: September 30, 2015.



- **Performance Assessment Key: Partially Achieved**
DDOT kicked off the 16th Street Transit Priority Study in January 2015. To date, staff is gathering data on existing conditions and has engaged with the public through a large public meeting, four public engagement events along the corridor, and three Citizens Advisory Groups. Based on this public feedback, DDOT has developed and shared three alternative approaches to improve transit conditions on 16th Street. The study is on track to be completed in Winter 2016.

Initiative 1.3: Complete a study of east side of downtown bicycle connections. (Sustainable DC Plan Transportation Action 2.1).

There is no continuous north-south bicycle facility east of 11th Street NW. In FY15 DDOT will conduct a planning study of north-south bicycle facilities to identify potential route(s), engage with community stakeholders, and conduct analysis. The study area will focus on the area between 7th and 4th Streets NW. **Completion Date: September 30, 2015.**

- **Performance Assessment Key: Partially Achieved**
DDOT began the study in Spring 2015, gathered existing conditions data, and began stakeholder engagement. The data-screening portion of the project is complete and DDOT has developed four potential bike lane solutions. Further planning and analysis along with public engagement will determine a preferred alternative in the winter of FY16.

OBJECTIVE 2: Research, Develop and Document Leading-edge Transportation Policies.

INITIATIVE 2.1: Support implementation of Performance Based Parking Zones (Sustainable DC Plan Transportation Action 3.1).

Performance Based Parking is a curbside parking management approach wherein metered rates and time limits are adjusted, dynamically, based on changes in parking demand. During FY15, DDOT is planning the expansion of performance parking zones through a detailed policy and implementation framework. DDOT will initiate a dynamic pricing pilot in the Chinatown/Penn Quarter area, and will implement zones District-wide. Implementation and management plans will be developed in cooperation with community stakeholders. **Completion Date: September 30, 2015.**

- **Performance Assessment Key: Partially Achieved**
Planning for the Chinatown/Penn Quarter dynamic parking pricing was completed in Q4 FY15, along with initial research into occupancy sensing technology. DDOT transitioned the pilot area to Pay-by-Space parking in October 2015, which will enable the development of detailed algorithms to predict parking occupancy on specific blocks based on available data. The pilot project will continue through FY16 and end in early FY17. Potential price adjustments and evaluation of the program will be continuing in FY16.



INITIATIVE 2.2: Comprehensive Curbside Management Policy (Sustainable DC Plan Transportation Action 3.1).

The management of curbside use is essential to the efficient functioning of the transportation system. A comprehensive curbside management study and report has provided the framework for balancing the debate about the often-conflicting demands on the curbside in the District. In FY15 DDOT will begin implementing a refined and coordinated approach for residential, commercial and visitor parking that will take into consideration Sustainable DC goals. Specifically, DDOT will work with three neighborhoods to develop comprehensive parking plans. DDOT will also explore citywide changes to existing programs that may require legislation and new regulations, which are to be determined. **Completion Date: September 30, 2015.**

● **Performance Assessment Key: Partially Achieved**

In FY15, DDOT began stakeholder engagement processes in three neighborhoods to develop comprehensive parking and curbside management plans. We met with stakeholders from Georgetown, DuPont Circle and Eastern Market neighborhoods. Through discussions with both business and residential stakeholders in these areas, we identified issues, developed new data analysis tools and methods, and began to identify solutions. This public input will inform citywide changes to existing programs that may require legislation and new regulations.

INITIATIVE 2.3: Implement Commercial Loading Zone Management Program.

Initial planning work was completed but implementation was not completed in FY14. The intent of the Commercial Loading Zone program is to assess a meter fee for the use of each of the approximately 500 commercial loading zones in the District of Columbia. The program will address curbside infrastructure, fees, payment methods, and enforcement techniques. Metering provides an efficient method for managing curbside loading zones; encouraging turnover, limiting double parking, and enhancing the overall efficiency of our transportation system. The program will also benefit the motor carrier industry with more curbside in which to operate, fewer parking violations, and improved overall safety and logistical processes. **Completion Date: September 30,, 2015.**

● **Performance Assessment Key: Partially Achieved**

DDOT successfully launched the Commercial Loading Zone program in January 2015 with paid parking for all Commercial Loading Zones in the District. To prepare for this launch, DDOT completed an analysis of all curbside commercial loading zones and cataloged these zones. The renewal period for the annual tags is approaching, and DDOT will open up 2016 tags for purchase in November/December of this year. PSA and PSRA will coordinate on issuing the 2016 tags.



OBJECTIVE 3: Champion a sustainable transportation system that meets the travel needs of the public, efficiently and affordably, while protecting the environment and the cultural resources of the District.

INITIATIVE 3.1: Fill 10 segments of priority sidewalk.

Sidewalks are important to advancing pedestrian safety and supporting the ability of District residents and visitors to walk comfortably to meet their everyday needs. DDOT has made progress in this area, but there are still significant sidewalk gaps in many places, and other locations have substandard sidewalks. DDOT will refine agency processes for identifying, prioritizing, and constructing new sidewalks. Priority will be placed on sidewalks near schools, transit stations, and in areas with large juvenile or senior populations. During FY15, DDOT will identify and build at least 10 segments of new sidewalks. **Completion date: September 30, 2015.**

Performance Assessment Key: Fully Achieved

In FY15, the PPSA at DDOT filled over ten segments of sidewalk gaps throughout the District. DDOT completed sidewalk installation projects through existing roadway resurfacing projects where sidewalks did not previously exist to help with the overall pedestrian experience and improve the safety of the pedestrian. In FY 16 DDOT will have a separate contract that will focus on missing segments along arterials that will improve pedestrian safety. Here are the segments that were completed in FY 15:

FEDERAL ADA COMPLIANCE:

Blair Rd. at Oglethorpe St. NW
Kansas Ave. at Blair Rd. NW
Branch Ave. at Highwood St. SE
Eastern Ave. at Perry St. NE
Tunlaw Rd. at W Pl. NW
Lowell St. at 44th St. NW
Southern Ave. and Urn St. SE

LOCAL SIDEWALK RESTORATION:

Bangor Street SE from 34th Street to 36th Street
Linnean Terrace NW from Dead End to Linnean Avenue
Greenvale Street NW from Chestnut Street NW to Western Avenue
32nd Street NW from Davenport Street to Ellicott Street
Meade Street NE from 50th Street to Eastern Avenue

INITIATIVE 3.2: Collect data and evaluate recent transportation projects. (Sustainable DC Plan Transportation Action 2.4)



DDOT will evaluate three recent transportation projects to determine whether they are performing as anticipated. In addition, DDOT will enhance its data collection functions by deploying at least 3 permanent bicycle-counting stations and will produce a report on bicycle and pedestrian performance information and gaps for further data collection. **Completion date: September 30, 2015**

● **Performance Assessment Key: Fully Achieved**

DDOT conducted a study of three recent projects, M Street NW, Sherman Avenue NW, and Naylor Road SE. Data collection and analysis is complete and DDOT is finalizing a public report and monitoring plan for these three projects that can be used to inform the planning and design of future DDOT projects. DDOT also installed 4 permanent bicycle and pedestrian counting stations: (1) 15th Street NW at N Street (bike only), (2) Eye Street SW at 3rd Street (bike only), (3) Metropolitan Branch Trail NE just north of Rhode Island Avenue (bike and pedestrian) and (4) 2nd Street NE at G Street (pedestrian only) and has developed plans for further deployment of this technology.

INITIATIVE 3.2 Review all DDOT policies, programs, and planning initiatives to ensure compliance with guidelines of the Age-Friendly DC Task Force and the Health in All Policies Task Force (Sustainable DC Transformation Order Section 10, Age-Friendly DC Goal: Domains # 1 & 2).

There are several overarching initiatives that have been launched to guide the District into a more sustainable future. The mission of the **Age-Friendly DC Task Force** is to ensure that the District will be an Age-Friendly City that is inclusive and accessible and encourages active and healthy aging. The **Health in All Policies Task Force** was established through the **Sustainable DC Transformation Order** that spelled out the steps necessary to make the District the healthiest, greenest, and most livable city in the United States. All DDOT policies, programs and planning initiatives will be evaluated to ensure that they meet the intent of these directives. **Completion Date: September 30, 2015.**

● **Performance Assessment Key: Fully Achieved**

DDOT participated in the completion of the Age-Friendly DC Task Force and has begun working to integrate the policy recommendations into agency work plans and programs. DDOT also actively participated in the Health In all Policies (HIAP) initiative and in drafting the final HIAP plan for the District. DDOT's sustainability policies (complete streets, Vision Zero, bike and pedestrian safety initiatives, sidewalk gap closure and maintenance) support HIAP by ensuring that all users of the transportation network have travel options suitable for their abilities.

KEY PERFORMANCE INDICATORS– Planning, Policy and Sustainability Administration



	KPI	Measure	FY 2014 YE Actual	FY 2015 YE Target	FY 2015 YE Revised Target	FY 2015 YE Actual (KPI Tracker)	FY 2015 YE Rating (KPI Tracker)	Budget Program (KPI Tracker)
	3.1	Percent of zoning case transportation impact reports submitted a minimum of 10 days before hearing	79%	100%		82.05%	82.05%	Planning, Policy and Sustainability Administration
	3.2	Vehicle miles traveled per capita	NA	5,550		5,354	96.46%	Planning, Policy and Sustainability Administration
	3.3	New sidewalk segments constructed	5	10		2	20%	Planning, Policy and Sustainability Administration

Transportation Operations Administration (TOA)

OBJECTIVE 1: Ensure that the District's current transportation assets (traffic signals, parking meters, streetlights) are in good condition and utilized at their optimal capacity.

INITIATIVE 1.1: Increase the number of networked parking meters and payment options. (Sustainable DC Plan Transportation Action 3.1).

To encourage more efficient use of curbside spaces, DDOT will continue to implement technologies to network 7,500 parking meters and implement approaches for parking management within the District. These technologies and approaches will result in different pricing strategies to encourage turnover or offer parking allowances for residents. **Completion Date: September 30, 2015**

Performance Assessment Key: Fully Achieved

DDOT completed a refresh of aged parking meter assets throughout major commercial sectors of the City, including installation of 934 new multi-space meters and 5,097 networked single space meters. This implementation established a network of parking meter technologies that are managed through a single backend system and allows DDOT to proactively maintain the assets and eventually make meter rate adjustments.



INITIATIVE 1.2 Optimize traffic signals. (Sustainable DC Plan Transportation Action 2.5).

DDOT will continue its program of systematically optimizing the timings of all its traffic signals. Optimized signal timing reduces delays, emissions and fuel consumption and results in smoother traffic flow. DDOT will have optimized timing plans for all of its signalized intersections (currently 1680). **Completion Date: September 30, 2015.**

● **Performance Assessment Key: Fully Achieved**

In FY15, DDOT completed Phase Two of this five-year project (optimizing all 1,600 plus traffic signals). Specifically, Phase Two included optimizing approximately 635 signals, which resulted in network-wide travel-time savings of 15.6% for passenger cars and 5% for buses. The signals optimized during Phase II were located in and around the downtown area between Rock Creek Parkway in the west, North Capitol in the east, U Street / Florida Avenue in the north, and I-395 in the south. Phase II also included a few intersections in Georgetown area along M St, N.W. Phase III will continue into FY 16 on the final round of intersections.

OBJECTIVE 2: Enhance operational efficiency, safety and customer service.

INITIATIVE 2.1: Enhance traffic signal operations by developing and implementing special timing plans for planned/special events and emergency response.

The safety and efficiency of the transportation network in the District is directly associated with the efficient operation of traffic signals. Planned and special events can create traffic congestion and disruptions to traffic flow. TOA will develop and implement special timing plans for planned/special events and emergency response. **Completion Date: September 30, 2015.**

● **Performance Assessment Key: Fully Achieved**

In FY 15, DDOT created special timing plans for each of the intersections that were part of the optimization process in Initiative 2.1. Each of these intersections was reviewed and new timing plans were also made for special events or emergency response. This process of optimizing the timing for regular traffic as well as developing timing plans for emergency events will continue in phase three. In both phase one and two DDOT developed timing plans for each intersection as it relates to emergency or special events.

INITIATIVE 2.2: Install green, energy-efficient streetlights (Sustainable DC Plan Energy Action 1.3, Nature Action 2.2).

In FY15 DDOT will continue to convert street and alley lights to Light-Emitting-Diode (LED). LED lights consume 50% less electricity and have a life-span of 15 years (compared to 6-months for incandescent, 2 years for mercury vapor and 4 years from high pressure sodium).









This is a multi-year initiative, with the overall goal of converting all streetlights to LED at a rate of 200 per fiscal year. **Completion Date: September 30, 2015.**

 **Performance Assessment Key: Not Achieved**

In 2011, DDOT issued an RFP for five-year Citywide Streetlight Asset Management services. Since 2011, there have been three protests from unsuccessful bidders. In 2015, DDOT reviewed all options for contract vehicles to meet the agency’s needs, with consideration of previous protests. Moving forward, DDOT intends to use all of its funding for asset management, LED conversion, and ensuring robust service and reliability. However, because DDOT is in the procurement process (solicitation development), the agency is protecting the confidentiality of internal procurement deliberations that occurred during FY15.

KEY PERFORMANCE INDICATORS– Transportation Operations Administration

	KPI	Measure	FY 2014 YE Actual	FY 2015 YE Target	FY 2015 YE Revised Target	FY 2015 YE Actual	FY 2015 YE Rating	Budget Program
	1.1	Average percentage of parking meters working daily	99.4%	98.0%		99.49%	101.52%	Transportation Operations Administration
	1.2	Percent of streetlights fixed within schedule of service (based type of repair required)	93.5%	92.0%		91.65%	99.62%	Transportation Operations Administration
	1.3	Percent of potholes filled within 48 hours	51.1%	90.0%		32.43%	36.03%	Transportation Operations Administration
	1.4	Number of signs installed/replaced (includes permanent and emergency no parking signs)	37,908	35,000		33,700	96.29%	Transportation Operations Administration
	1.5	Miles of pavement markings	193	100		135	135%	Transportation Operations Administration



		refreshed						
●	1.6	Number of Citations per Traffic Control Officer (TCO)	2002	2500	1952.5	78.10%	Transportation Operations Administration	
●	1.7	Fatality Rate per 100 million vehicle miles traveled (VMT)	1.17	0.5	2.52	19.84%	Transportation Operations Administration	
●	1.8	Number of crashes per million vehicle miles traveled (VMT)	2.84	3	6.83	43.92%	Transportation Operations Administration	
●	1.9	Number of injury crashes per million vehicle miles traveled (VMT)	0.75	1	1.91	52.36%	Transportation Operations Administration	

Public Space Regulation Administration (PSRA)

OBJECTIVE 1: To increase and improve the timeliness, consistency, transparency and completeness of public space permits.

INITIATIVE 1.1: PSRA will build on its Operation Smooth Street program to ensure restorations occurring following the regulatory established Winter Moratorium are coordinated and proactively addressed.

Regulations establish a moratorium on final restorations for excavations of the roadways between the months of November through March. As a result, in the early spring there are thousands of temporary restorations across District roadways from utility work performed in those months. PSRA will begin planning for final restoration of these excavations in the late winter, leveraging information technology to integrate District and utility records of unrestored locations. PSRA will streamline the permitting and inspection processes so work can commence when the weather turns. PSRA plans to ensure at least 1,500 excavations are identified, restored, and inspected by the close of the Operation Smooth Streets program.

Completion Date: June 30, 2015.

● **Performance Assessment Key: Fully Achieved**

Operation Smooth Streets has completed a successful season. 1,040 roadway locations were temporarily restored during the winter moratorium. Utilizing IT tools and partnering with the



utilities to expedite their restoration, PSI lead the PSRA team to have 1,019 of these locations restored by the end of the program, reflecting a 98 percent completion rate. Notices of Violation were issued to the utilities for the 21 locations that have not been restored.

INITIATIVE 1.2: PSRA will coordinate utility capital improvement projects (CIP) to reduce duplicative excavations and to minimize impacts on neighborhoods during CIP work.

The major utilities perform hundreds of large scale Capital Improvement Projects (CIPs) annually. These projects range in size from one block to city-wide programs. Many of these projects are years in the planning stages and often can be situated in the same areas. When not coordinated this results in needlessly duplicative excavations. These redundant excavations also are more costly and reduce the quality of life for residents for extended periods while serial construction sites are set up and dismantled.

PSRA will begin and implement a program to coordinate the major utilities CIP projects. Leveraging existing IT tools and building on the established program wherein DDOT coordinates its infrastructure projects with utilities, PSRA will map out the upcoming utility projects for the next two years, including locations and timelines. PSRA will monitor the utilities work and records to make sure the information is accurate and up to date. Through the permit process PSRA will coordinate time and location of excavations. In the field PSRA will work with utility crews and contractors to make sure construction activity takes place in a uniform, timely, and efficient manner. **Completion Date: September 30, 2015.**



Performance Assessment Key: Fully Achieved

PSRA (PSI, Plan Review, and Permits Team) continues to participate in IPMA's monthly coordination meeting in an effort to monitor and ensure duplicative excavations are eliminated. These meetings inform the utilities of IPMA's Capital Improvement Projects (CIPs) several years in advance. The utilities are able to plan/coordinate all excavations/repairs before the CIPs begin. During these meetings IPMA and the Utilities review the status of ongoing projects as well. Additionally, PSI attends the monthly Utility Construction Meeting. This meeting is established by IPMA and Chaired by Thomas Fulton. It is designed to utilizing the opportunity to provide an overview of your IPMA/DDOT projects, and to positively and productively surface potential conflicts that can be resolved, mitigated quickly or thru further consultation with the project team.

OBJECTIVE 2: Increase the knowledge, skills, and ability of staff in the performance of duties

INITIATIVE 2.1: PSRA will enhance the Preliminary Design Review Meeting process.

PSRA issues permits for development projects. The pace and amount of development projects in the District are both increasing. PSRA has been given the complete management of the Preliminary Development Review Meeting (PDRM) process. PDRMs are held at the early to mid-design phases for larger development projects. These projects typically involve



the most complex and multifaceted uses of public space. PSRA will enhance the PDRM process through process reengineering and solicitation of stakeholder feedback. It will enter into Level of Service agreements with internal and external reviewers and will establish transparent timelines and deliverables for all parties involved in the PDRM process. It will create incentives for reviewers and applicants to participate in and follow through on the commitments made in PDRMs. It will standardize inputs and outputs of the program. Monitoring of progress and delivery on commitments will be measured to demonstrate the tangible benefits adhering to all participants. **Completion Date: September 30, 2015.**

 **Performance Assessment Key: Partially Achieved**

The draft level of service agreement has been revised based on input from stakeholders and analysis of existing process. This revised program will be implemented in FY16.

INITIATIVE 2.2: PSRA will create greater consistency and transparency in the Public Space Committee application process.

PSRA provides administrative support to the Public Space Committee (PSC), a multi-agency body established through a Mayor's Order that makes determinations on certain classes of public space permit applications. The PSC is similarly situated to other government bodies such as the Alcoholic Beverage Control Board (ABC), the Board of Zoning Adjustment (BZA), and the Zoning Commission (ZC). To ensure the PSC is delivering consistent, transparent, and efficient service PSRA will perform a complete review of its processes, including identification of the classes of applications submitted to it for decisions; a review of the regulations and Mayor's Order to ensure its actions are properly aligned with its jurisdiction; and a mapping of its current processes. It will conduct best practices research of the ABC, BZA, and ZC processes. It will solicit feedback from internal and external stakeholders including applicants, associations, and Advisory Neighborhood Commissions. It will enter into Level of Service agreements with internal and external reviewers and will establish transparent timelines and deliverables for all parties involved in the PSC process. It will enhance its online tools and will publish its agendas and actions on an established calendar published in the DC Register. It will consult with the Office of Boards and Commissions to ensure it is meeting all requirements including openness and transparency. **Completion Date: September 30, 2015.**

 **Performance Assessment Key: Fully Achieved**

The PSC has benchmarked its operations against other government boards and commissions and has also participated in training from the Mayor's Office of Talent and Appointments. As a result, the PSC has modified its practices to conform more closely with the Open Meetings Act. These changes, which include how meetings are conducted (e.g. roll call votes for all actions) and how it administers the application process (e.g. file review attendance has been revamped to ensure compliance with the Open Meetings Act) have substantially increased the transparency and accountability of the process. This work will continue into FY16.



KEY PERFORMANCE INDICATORS- Public Space Regulation Administration (PSRA)

 	KPI	Measure	FY 2014 YE Actual	FY 2015 YE Target	FY 2015 YE Revised Target	FY 2015 YE Actual	FY 2015 YE Rating	Budget Program
	1.1	Percent of public space permits processed on time	95.7%	94%		95.64%	101.75%	Public Space Operations Administration
	1.2	Online public space permits issued	10,298	12,000		16,408	136.73%	Public Space Operations Administration
	1.3	Weekly field inspections and field services performed	3511	1,000		3696	369.60%	Public Space Operations Administration
	1.4	Average days for a technical review approval	4	6		15	N/A – None Listed	Public Space Operations Administration
	1.5	Average inspections review days	5	6		24	N/A – None Listed	Public Space Operations Administration

Office of the Director

OBJECTIVE 1: Implement and enhance sustainable, environmentally friendly practices and alternative transportation modes (OCAP – Action Item 1.4.5, 3.7.1,3.7.2 and Indicator 3C).

INITIATIVE 1.1 – Conduct agency sustainability assessment using OCA approved criteria developed by DDOE and OP in accordance with Mayor’s Order 2013-209 (Sustainable DC Governance Goal 1, Action 1.2; Built Environment Goal 3)









Within one hundred twenty (120) days after the City Administrator approves sustainability assessment criteria developed jointly by the District Department of the Environment and the Office of Planning, each agency head subject to the authority of the mayor shall use the criteria to evaluate the sustainability of their respective operations in accordance with the requirements of Mayor’s Order 2013-209, the Sustainable DC Transformation Order, and submit to his or her responsible Deputy Mayor and the Office of the City Administrator the results of the agency’s internal assessment. **Completion Date: April 2015**

 **Performance Assessment Key: Partially Achieved**

DDOT completed and submitted the agency's internal sustainability assessment in FY15. The information submitted corresponded to the established criteria under executive order 2013-209 and identified ways to improve DDOT's operational sustainability. Specifically, DDOT examined and responded on matters related to energy-savings, sustainable products, and printing policies. DDOT continues to work with DOEE on future adaptation plans and projects to enhance sustainable activities.

KEY PERFORMANCE INDICATORS- Office of the Director

   	KPI	Measure	FY 2014 YE Actual	FY 2015 YE Target	FY 2015 YE Revised Target	FY 2015 YE Actual	FY 2015 YE Rating	Budget Program
	1.1	Number of Capital Bikeshare stations in DC	197	240		817	340.42%	Planning, Policy and Sustainability Administration
	1.2	Number of street/alley lights converted to Light-Emitting-Diode (LED)	364	200		481	240.50%	Transportation Operations Administration

WORKLOAD MEASURES – APPENDIX

WORKLOAD MEASURES



Measure Name	FY 2013 YE Actual	FY 2014 YE Actual	FY 2015 YE Actual	Budget Program
Number of street tree spaces or boxes under DDOT jurisdiction	150,841	147,376	623,938	Urban Forestry Administration
Number of public space permits issued	24,482	37,385	41,762	Public Space Regulation Administration
Total violations written by Traffic Control Officers (TCO's) annually	323,498	278,475	205,733	Transportation Operations Administration
Number of crashes	19,453	21,058	21,862	Transportation Operations Administration
Number of fatalities	32	42	45	Transportation Operations Administration
Number of pedestrian fatalities	8	4	11	Transportation Operations Administration
Number of motorcycle fatalities	4	3	3	Transportation Operations Administration
Number of bicycle fatalities	1	0	0	Transportation Operations Administration
Total number of service requests	158,564	140,050	137,034	Office of the Director
Number of incidents responded by Traffic Management Center (TMC) & Roadway Operation Patrol (ROP)	4,973	6,268	8,431	Transportation Operations Administration
Number of students in School Transit Subsidy Program	18,798	65,063	30,499	Progressive Transportation Administration

Question 13

DISTRICT DEPARTMENT OF TRANSPORTATION
Operating Budget/Expenditures by Administration - FY15 and FY16

FY15 Approved Budget PRE-CAFR				FY16 Approved Budget as of 12/31/15 (1st QTR)				
	FY15 Approved Budget PRE-CAFR	FY 15 Expense/Obligation	Variance	Variance Description	FY16 Approved Budget as of 12/31/15 (1st QTR)	FY16 1st QTR Expense/Obligation	Variance	Variance Description
AMP (OD)								
PS	9,809,646	9,645,656	163,990		6,548,792	2,158,850	4,389,942	
NPS	5,747,216	5,657,388	89,828		5,768,745	5,110,322	658,423	
Subtotal	15,556,862	15,303,044	253,818		12,317,537	7,269,172	5,048,365	
IPMA								
PS	2,140,048	2,136,169	3,879	NPS: Variance of \$0.4M of authority was left in fund 6909 Transportation Mitigation Fund for IPMA.	1,662,780	270,364	1,392,416	
NPS	521,266	57,512	463,754		6,614,525	3,681	6,610,844	
Subtotal	2,661,314	2,193,681	467,633		8,277,305	274,045	8,003,260	
PTSA								
PS	1,944,901	1,943,380	1,521		1,707,425	466,269	1,241,156	
NPS	10,012,397	9,956,858	55,539		10,201,360	8,431,424	1,769,936	
Subtotal	11,957,298	11,900,238	57,060		11,908,785	8,897,693	3,011,092	
PPSA								
PS	3,200,769	3,191,066	9,703	NPS: Variance of \$1.1M of NPS SPR fund 6901 due to timing of funding awards within the Agency. In FY2016, a more rigorous spend plan in place and currently 90% of funding for fund 6901 has been expended or obligated.	2,574,398	682,908	1,891,489	
NPS	15,905,199	14,616,724	1,288,475		24,733,007	9,765,797	14,967,210	
Subtotal	19,105,968	17,807,790	1,298,178		27,307,405	10,448,705	16,858,699	
TOA								
PS	18,138,302	18,103,560	34,742	NPS: Variance of \$700K of fund 100 NPS due to contractual savings for parking operations and street & bridge maintenance; lastly \$800K of authority was left in fund 6909 Transportation Mitigation Fund for TOA.	19,233,103	4,220,398	15,012,705	
NPS	18,809,249	16,910,562	1,898,687		24,208,395	16,639,951	7,568,444	
Subtotal	36,947,551	35,014,122	1,933,429		43,441,498	20,860,349	22,581,149	
UFA								
PS	757,364	755,720	1,644		729,445	74,293	655,152	
NPS	1,373,810	1,367,805	6,005		1,205,183	100,255	1,104,928	
Subtotal	2,131,174	2,123,525	7,649		1,934,628	174,548	1,760,080	
PSRA								
PS	5,301,155	5,297,063	4,092		6,248,971	1,461,541	4,787,430	
NPS	331,480	307,258	24,222		331,480	84,261	247,219	
Subtotal	5,632,635	5,604,321	28,314		6,580,451	1,545,802	5,034,649	
AFO								
PS	1,544,650	1,543,943	707		1,643,729	353,869	1,289,860	
NPS	15,000	15,000	-		15,000		15,000	
Subtotal	1,559,650	1,558,943	707		1,658,729	353,869	1,304,860	
ADMIN TOTAL								
PS	42,836,835	42,616,557	220,278		40,348,643	9,688,492	30,660,150	
NPS	52,715,617	48,889,107	3,826,510		73,077,695	40,135,691	32,942,004	
	95,552,452	91,505,664	4,046,788	PS balance is due to turnover for administrative support staff. NPS balance is due to lower than anticipated cost of operations. O type balance of \$2.4M is due to a delay in planned spending. Overall year end budget expended 96%.	113,426,338	49,824,183	63,602,154	First quarter expended / obligated 44%.
TOTAL								

*Administration Variance Description formatted to include comments from Resource Management.

Question 14 - Reprogramming - FY2015

Original Use of Funds (From)	Use of Funds (To)	Amount	Purpose
Contractual service for TOA (Fund 0100 - 5020 - 0041)	Uniforms for staff TOA (Fund 0100 - 5020 - 0020)	\$ 115,000.00	Funds are needed to purchase uniforms and boots for Street and Bridge Maintenance program within TOA.
KEO - WMATA Fund 6030 (DC Circulator)	KEO - WMATA Fund 0601 (Parking Meters)	\$ 2,836,313.99	Funds are needed to allow WMATA to properly align budget with planned spending for the DC Circulator Program.
Capital Project 11th Street Bridge - Fund 0350 (HTF00A/04)	Capital Project Maintenance - Fund 0350 (MNT00A/04)	\$ 5.00	Funds are needed to be properly aligned in the Master Projects to correspond to DDOT's planned obligations.
AMP-Property Management - 0041 - Fund 0100 - 1030	AMP-Property Management - 0020 - Fund 0100 - 1030	\$ 15,000.00	Funds are needed to purchase materials to repair the sand filters and manholes at Farragut. (Within AMP)
DDOT Capital Budget - Project TRF01C - Fund 0301	(Reverse PayGo Project PA0 RPA02C Fund 0301) to DMPED operating budget (EBO)	\$ 2,000,000.00	The reprogrammed PayGo capital budget will support the financing costs of the DC United Soccer Stadium.
Streetcar Revenues Fund 6908 CSG 41	Transportation Infrastructure Mitigation Fund 6909 CSG 41	\$ 449,680.00	There is no anticipated revenue for Streetcar this fiscal year and budget authority is need in the Transportation Infrastructure Mitigation.
Transportation Infrastructure Mitigation - Fund 6909 5010 - 0040	Fund 0301 PayGo to Capital Project EW002C/01 Fund 0331 - 0409	\$ 458,653.33	The funds are needed to allow DDOT on behalf of CSX to compensate the vendor for CSX work on the 11th St, SE bridges.
KEO - WMATA project SA311C/04 Fund 0300	A new DCNG project (AM0) NG715C, Youth Challenge Educational Campus	\$ 700,000.00	It will enable the Department of General Services (DGS) to improve the outdoor security lighting system at the DCNG's Youth Challenge Educational Campus.
Multiple Projects within KA0 - Capital Fund 0345 O-Type Fund 6909 (Transportation Infrastructure Mitigation - 5010)	Multiple Projects within KA0 - Capital Fund 0345 Pay-As-You-Go Local Capital Fund 0301 in project CI063A /03(0011) & 04(0041)	\$ 2,957,285.01 \$ 345,431.82	Funds are needed in various projects and phases to meet the contractual estimates. The reprogramming will ensure the TIGER grant is properly aligned. The funds are needed for traffic signal work at the intersection of 8th Street and Florida Avenue, NW.
Transportation Infrastructure Mitigation - 5010 - Fund 0100 - 0040	PayGo Capital to Project CD044A/01 0011 & 0041 Fund 0301, Anacostia Waterfront Initiative	\$ 350,000.00	The budget is needed to allow DDOT on behalf of the U.S. General Services Admin (GSA) to obtain permits to complete FY2015 project requirements.
Operating Budget (IPMA - 2010 - Fund 0100 - 0041)	PayGo Capital to Project SR098C/01, Fund 0301 - 0041 & 0011	\$ 2,000,000.00	The funds are needed to allow DDOT to complete the work requested for Ward 8
Local Fund 0100 - Planning, Policy and Sustainability Administration (PPSA - 4010)	Local Fund 0100 - Transportation Operations Administration (TOA - 5010)	\$ 918,000.00	The funds are needed to execute pavement marking activities throughout the District.
Capital Project Maintenance - Fund 0350 (MNT00A/04)	Capital Project 11th Street Bridge - Fund 0350 (HTF00A/04)	\$ 5.00	Funds are needed to be properly aligned in the Master Projects to correspond to DDOT's planned obligations.
Capital Fund 0300 and Fund 0330 within local capital projects (PM301C, PM303C & PM304C)	Local Capital Project Neighbor Parking Fund NPP01C and Parking Planning PM302C	\$ 666,667.00	Funds are needed to fulfill priority requests for improvements in three Performance Parking Zones (Columbia Heights, H Street & Ballpark Area).
Transportation Infrastructure Mitigation Fund 6909 - TOA 5010 - 0040	PayGo to Local Capital Project MRR16C/01 Fund 301 - 0409&0111 Virginia Avenue Tunnel	\$ 1,202,900.00	The budget is needed to allow DDOT to complete project requirements (design reviews, permitting and field verification activities).
Local Fund 0100 - Infrastructure Project Management Administration (IPMA) - 0050	Transportation Operations Administration (TOA) - Snow Funds - 0013	\$ 342,939.00	Funds are needed to cover overtime expended during the snow season.
Capital Budget Fund 0300	Metro Memorial Park	\$ 521.66	Funds are needed to support the cost of park construction
Master Lease Capital Budget	Department of Parks and Recreation (DPR)	\$ 405,819.55	Funds are needed to help support the costs of purchasing vehicles for the DPR fleet to transport citizens to recreational programs through the District.
Fund 6909 Center Leg Freeway Pilot - IPMA 2010 - 0041	Fund 0301 Center Leg Freeway - CDTB6A/04 - 0409&0111	\$ 1,779,433.00	Budget is needed to support DDOT's cost for design completion and construction review on the Capitol Crossing Project.
TOA - 5010 - Fund 06909 - 0409	IPMA - 2010 - Fund 6395 - 0409	\$ 1,779,433.00	Budget is needed to support DDOT's cost for design completion and construction review on the Capitol Crossing Project.

Question 14 - Reprogramming - FY2015

Original Use of Funds (From)	Use of Funds (To)	Amount	Purpose
PayGo Fund 0301 within Capital Project LTCMOC (Long Term Control)	PayGo Fund 0301 within Capital Project TID01C (Traffic Infrastructure Development)	\$ 83,638.48	Funds are needed to allow spending in accordance with the revenues received from developer agreements for traffic infrastructure services
Special Purpose Operating Budget - TOA 5010 - 0041	As PayGo to project TID01C/01 - 0409, Traffic Infrastructure Development Project	\$ 39,000.00	The budget is needed to allow TOA to make safety improvements around Kecham Elementary School.
Special Purpose Revenue Funds - Fund 6904 - PPSA 4010 - 0041	As PayGo local capital project BEE00C/04 - 0409 - Fund 0301 - Bus Efficiency Enhancements	\$ 5,297,923.00	The budget will be used to improve bus service and the bus customer experience by improving bus facilities in DC.
Special Purpose Operating Budget - Fund 6902 - PPSA 4010	As PayGo capital budget to project NPP01C/04 - 0409 - Neighborhood Parking Performance	\$ 2,255,469.00	The budget is needed to allow DDOT to procure awarded community projects to complete project requirements.
Fund 6903 - Bike Share - PPSA 4010 - 0041	As PayGo to Project MRR16C/01 - 0409&0111, Virginia Avenue Tunnel Project Fund 0301	\$ 1,541,000.00	The budget is needed to allow DDOT to complete project requirements (design reviews, permitting and field verification activities).
Local Fund 0100 - PPSA 4010 - 0041	As PayGo Capital budget to project ED311C/01 - 0409 - Kennedy Street Streetscape Fund 0300	\$ 300,000.00	The budget is needed to advance the Kennedy Street Streetscape project.
Local Fund 0100 Various Admins 0040 & 0041	As PayGo Capital budget to project SR098C/01 - 0409 - Ward 8 Streetscapes Fund 0300	\$ 1,439,272.00	The budget is needed to advance the redesign of the intersection of Martin Luther King Jr. Ave SE and Malcolm X SE in Ward 8.
Local Fund 0100 - TOA Citywide Program 5090 - 0041	As PayGo Capital budget to project TRL50C/01 - 0409 - Trails - Fund 0300	\$ 1,424,922.03	The budget is needed to provide the resources to initiate and continue planning and designing activities associated with the District's trail system.
Local Fund 0100 Operating Budget - Debt Services payment to DC Water & Parking Operations	As PayGo Capital budget to BR101C - Fund 0300 - Kenilworth Parkside Pedestrian Bridge	\$ 1,080,000.00	The funding will connect the redeveloped Kenilworth Parkside community with the Deanwood METRO station across I-295.
KEO WMATA Surplus Capital Budget	Office of the Chief Technology Officer	\$ 500,000.00	The funds are needed to support the second phase of an information technology system to be utilized across multiple agencies.

FY15 Intra- District MOU

Request Date	Buyer Agency	Seller Agency	Description of Service	Amount
September 11, 2014	DDOT	OCA	McMillian Storm Water Storage and NE Boundry Tunnel Activites (No Cost)	\$ -
September 26, 2014	DMPED	WMATA/DDOT	Design services for congress metro station (No money was exchanged between DMPED and DDOT)(No Cost)	\$ -
October 29, 2014	DDOT	OCME	The award of grant funds provided by the National Highway Traffic Safety Administration	\$ 100,000.00
October 31, 2014	DDOT	OAG	Operate the Traffic Safety Resource Prosecutor (TSRP) Program	\$ 162,000.00
November 4, 2014	DDOT	OAG	Operate the Impaired Driving (DWI) and Driving Under Influence (DUI) Prosecutor Program	\$ 392,000.00
November 12, 2014	DDOT	OCTO	Support for a setup and data transfer of 300 PCs	\$ 27,000.00
November 17, 2014	DDOT	MPD	The installation of closed circuit TV Crime Cameras, License plate reader cameras & PE (No Cost)	\$ -
November 21, 2014	DDOT	DCHR	Suitability and compliance services in accordance with background checks, drug/alcohol testing	\$ 22,404.50
November 26, 2014	DDOT	DPW	Drug and alcohol testing and training	\$ 144,000.00
December 3, 2014	DDOT	OCTO	Guardrail Tracking Technology Program	\$ 100,000.00
December 3, 2014	DDOT	MPD	Various traffic safety related enforcement activities including DUI enforcement and pedestrian safety initiatives	\$ 1,609,325.70
December 23, 2014	DDOT	OCP	Delegated Procurement Authority	\$ 1,055,954.48
January 22, 2015	DDOE	DDOT	5 full - time DDOT employees in IPMA Stormwater Program	\$ 2,019,694.00
March 18, 2015	DDOT	DGS	Hire an Armed Special Police Officer to guard DDOT'S G ST Facility	\$ 120,780.00
March 19, 2015	DDOT	OCTO	IT ServUS - Network Connectivity	\$ 50,000.00
March 24, 2015	DDOT	MPD	Various traffic safety enforcement activities	\$ 1,640,982.22
April 21, 2015	DDOT	MPD	Body cameras	\$ 50,000.00
April 30, 2015	DDOT	FEMS	Upgrade FEMS simulators	\$ 351,048.54
June 4, 2015	DDOT	OAG	To provide litigation, advice-giving and programmatic support	\$ 56,636.00
July 24, 2015	DGS	DDOT	Relocation of a Traffic Signal at 4811 MacArthur Boulevard, NW	\$ 2,557.00
August 11, 2015	DDOT	MPD	MPD will monitor and control traffic and provide security for the workers in high risk areas of DC	\$ 125,000.00
September 17, 2015	DDOT	DDOE	DDOE will install, maintain, and clean a floatable trash trap at Nash Run in Northeast (No Cost)	\$ -
September 18, 2015	OCFO	DPW	DPW pay OCFO for auditing and accounting services for several agencies in the Government Services Cluster	\$ 829,816.00
September 21, 2015	DDOT	DDOE	Fiscal Year 2012 MS4 Enterprise Funds (No Cost)	\$ -
September 21, 2015	DDOT	FEMS	Purposed of issuing a public space permit needed for the renovation of an existing building for FEMS	\$ 45,055.56
September 29, 2015	DDOT	OUC	Provide access to the city wide radio system in order to achieve communications for buyers users & interoperability	\$ 22,835.00
August 11, 2015	DDOT	OP/SHPO	Amendment - Expedited review of DDOT projects for fiscal Year 2016 (FTE)	\$ 140,000.00
August 20, 2015	DDOT	OCFO	Funding for one FTE for OCFO to collect Public Space surface rental bills in FY15	\$ 109,434.42

FY16 Intra- District MOU

Request Date	Buyer Agency	Seller Agency	Description of Service	Amount
July 30, 2015	DDOT	DDOE	To install stormwater reduction devices and technologies in the public space	\$ -
August 4, 2015	OP	DDOT	Implementation of Sustainable DC Innovation Challenge, Pavers on CT Ave, NW	\$ 50,000.00
August 11, 2015	DDOT	OP/SHPO	Amendment - Expedited review of DDOT projects for fiscal Year 2016	\$ 140,000.00
August 20, 2015	DDOT	OCFO	Funding for one FTE for OCFO to collect public space surface rental bills in FY15	\$ 109,434.42
September 15, 2015	DDOT	DGS	To perform preliminary work to quantify the risks associated with proposed development of the green space along PA AVE	\$ 200,000.00
October 6, 2015	DDOT	DCCAH	Provide DCCAH assistance with an art event called Art All Night	\$ 3,147.00
October 24, 2015	DDOT	JR0	For cost of sign language interoperation services from ODR	\$ 3,000.00
October 27, 2015	DDOT	OCME	The OCME employ one FTE who will perform necessary toxicology casework and improve the chemical testing knowledge base	\$ 165,000.00
November 4, 2015	DDOT	DCHR	To provide funding for the Capital Fellows Program in FY16	\$ 112,697.00
November 4, 2015	DDOT	FEMS	To upgrade the existing FEMS simulator so that it can mimic various District Traffic & other incident scenarios	\$ 351,048.54
November 4, 2015	DDOT	OAG	Administrative costs, courier and transportation, and telecommunication services	\$ 162,000.00
December 17, 2015	DDOT	OAG	Administrative costs, courier and transportation, and telecommunication services	\$ 392,000.00
December 23, 2015	DDOT	MPD	For various safety related enforcement activities and to include DUI enforcements and pedestrian safety initiatives	\$ 2,745,595.63
January 6, 2016	DPW	OSSE	DDOT will provide training and review applicable invoices	\$ -
February 3, 2016	DDOT	DCTC	DC Taxicab Commission will provide service of taxi trips to & from eligible facilities for district residents enrolled in MetroAccess	\$ 2,800,000.00
August 3, 2015	DDOE	DDOT	Clean Water Act State Revolving Fund Projects	\$ 3,780,774.00
February 11, 2016	DDOT	OUC	Citywide Radio System, Computer-Aided Dispatch and Mobile Data Services	\$ 51,502.81

Question 16

Dedicated Taxes and Special Purpose Revenue

Revenue Source Name	Code	Source	Statutory Reference	About the Fund			Amount generated			Expenditures			Balance		
				Description	Fee and How it is Set	Who Pays?	FY14 Post CAFR	FY15 Pre CAFR	FY16 Certified	FY14 Post CAFR Expenditures	FY15 Pre CAFR	FY16 as of December 31, 2015	FY14 Post CAFR	FY15 Pre CAFR Balances	Expected Balance at end of FY16
General O-Type Revenue Fund	6000	DC Budget Support Act	DC Budget Support Act	DDOT collects revenue for various services rendered for/on behalf of private entities for special events. Revenue collected is used to fund DDOT initiatives and programs	Private entities deposit money in advance of the specified service being rendered by DDOT.	Vendors, sponsors or privated entities who put on the events.	899,862	168,314	200,000	869,502	123,323	-	30,360	44,991	-
WMATA Projects	6030	N/A	N/A	Current Project DC Circulator bus runs frequently on selected designated routes in DC. Farebox revenue is credited to KA0 to maintain circulator bus service.		Citizens of the District	4,077,794	3,126,813	5,197,794	4,077,794	3,126,813	510,896	-	-	-
Tree Fund	6140	DC Law 14-309	DC Law 14-309	Urban forest preservation program; requires a special tree removal permit and community notification. The Tree Fund is used to plant trees and maintain tree canopy.	\$35 by Circumference DC Law 14-309	Citizens of the District	697,817	838,692	850,000	29,506	1,000,000	-	668,311	(161,308)	-
Reimbursable Repairs	6261	D.C. Law 11-198	D.C. Law 11-198, Title 24 DCMR 225.1 Public Space Permit Fees	The District of Columbia Department of Transportation requires that any private entity deposit money in advance of scheduled work on any public space in the city, including streets, alleys, and sidewalks.		Citizens of the District, developers	(128,162)	(32,755)	-	-	-	-	-	-	-
Center Leg Freeway	6395	D.C. 18-806	Amend Chapter 46 of Title 47, DCMR	to provide for payments in lieu of taxes for real property including air rights, above and adjacent to the Center Leg Freeway(Interstate 395)	The fee is equal to real property taxes based upon the value of the real property in the Center Leg Freeway PILOT Area.	Affiliates or assignees approved by the Mayor.	390,364	-	-	-	-	-	-	-	-
Mall Tunnel Lighting	6555	DC Forma Agreement #2861	DC Forma Agreement #2861	Depository for revenue received by DDOT from General Service Administration for lighting, ventilation and maintenance of 2nd/3rd St Mall Tunnels. Revenue collected is used for PEPCO billing.	50% cost for lighting, ventilation, and maintenance of 2nd/3rd St Mall Tunnels	General Services Administration	456,408	506,188	260,000	254,165	252,023	-	202,243	254,165	-
Pedestrian & Bicycle Safety	6645	SEC.6020	SEC.6020	To enhance the safety and quality of the pedestrian and bicycle transportation, including traffic calming and safe routes to school enhancement.	1.5M transferred from the fines generated from the enhancement neighborhood parking control imitative enhancement.		433,459	402,346	300,000	43,801	146,653	-	389,658	255,693	-
DDOT Enterprise Fund- Non Tax Revenues	6901	D.C. Law 18-370;58DCR662	D.C. Law 18-370;58DCR662	The District Department of Transportation Enterprise Fund shall be administered by the Director to pay for goods, services, property, capital improvements or any other permitted purpose as authorized by section 5 and into the Highway Trust Fund	Fines from the enforcement of truck safety and size, advertisement for bikeshare and multi space parking meters	Vendors, visitors, constiuents, Citizens	339,186	7,234,987	5,532,669	508,335	2,884,786	151,087	(169,149)	4,350,201	-
Bicycle Sharing Fund	6903	D.C. Law 14-137; D.C. Official Code 50-921.01 et seq)	D.C. Law 14-137; D.C. Official Code 50-921.01 et seq)	To develop policies and programs to encourage and provide for the safe use of bicycles for recreation and work related travel.	This fund shall be administered by the Director of the Department of Transportation to pay for goods, services property	Vendors, visitors, constiuents, Citizens	4,443,407	6,765,373	8,238,668	5,070,330	6,851,604	1,770,877	(626,923)	(86,231)	-
Sustainable Transportation	6904	D.C. Law 19-168, amended	D.C. Official Code 50-921.15	Non-papsing, interest bearing fund that was established to finance approved DDOT capital projects for bus-operating enhancements.	The fund receives the amount of motor vehicle parking fees that exceed the amount specified in the District's budget and financial plan to be transferred to WMATA as an operating subsidy.	Vendors, visitors, constiuents, Citizens	(2,317,296)	-				-			
Pay by Cell	6905	56 Stat. 91; D.C. Official Code 50-2603(8)	56 Stat. 91; D.C. Official Code 50-2603(8)	District Department of Transportation Parking Meter Pay-by Phone Transaction fee fund	Revenue collected via cell phone for street parking. All funds shall be deposited into the Fund Beginning October 1 2012	Vendors, visitors, constiuents, Citizens	2,560,700	-	3,234,065	2,560,700	-	-	-	-	-
Transp Infrastructure Mitigation	6909	D.C. Law 20-128	D.C. Law 20-128	Non lapsing, interest-bearing fund that was established to finance DDOT's review of a project that may affect the transp. Infrastructure or public space in the District	Revenue collected from individuals or entities (such as a developer, property owner, utility company, the federal government or other government agency) or from the Zoning Commission or Board of Zoning Adjustment for transp infrastructure or public space improvements or mitigation measures	Vendors, visitors, constiuents, Citizens	39,815	3,421,422	1,891,000	-	-	-	39,815	3,421,422	-

Revenue Source Name	Code	Source	Statutory Reference	About the Fund			Amount generated			Expenditures			Balance			
				Description	Fee and How it is Set	Who Pays?	FY14 Post CAFR	FY15 Pre CAFR	FY16 Certified	FY14 Post CAFR Expenditures	FY15 Pre CAFR	FY16 as of December 31, 2015	FY14 Post CAFR	FY15 Pre CAFR Balances	Expected Balance at end of FY16	
Vision Zero Pedestrian & Bicycle Safety	6910	D.C. Law 17-219, amended	D.C. Law 17-219, D.C. Code 1-325.131, amended	Non-lapsing, interest-bearing fund established solely to enhance the safety and quality of pedestrian and bicycle transportation, including traffic calming and Safe Routes to School enhancements.	Revenue collected from fines associated with automated traffic enforcement initiatives.	Vendors, visitors, constituents, Citizens			500,000							
TOTALS							11,893,354	22,431,380	26,204,196	13,414,133	14,385,202	2,432,860	534,315	8,078,933	-	

DC NUMBER	PROJECT TITLE	PROJECT DESCRIPTION	AVAILABLE FUNDS (1.29.2016)	Delivery Date
4DBBEL	DHCD BELLEVUE	Under this contract, construction work consists of the upgrading of street and pedestrian lighting facilities along South Capitol Street between Southern Avenue and Galveston Street in Ward 8. This include, Repairs to existing pavements and structures incl	\$394,454	COMPLETED/CLOSEOUT
6EQ01C	EQUIPMENT REPLACEMENT	This project is for the replacement cost for fleet, primarily light vehicles used by DDOT inspectors, engineers for work throughout the city.	\$2,346,088	ONGOING
6EQ02C	MAJOR EQUIPMENT PURCHASES	This project is for the replacement cost for fleet, primarily light and heavy vehicles used by DDOT for work throughout the city	\$0	ONGOING
6EQ05C	PARKING METERS	Purchase of Parking Meters	\$4,271,964	ONGOING
999930	CAPITAL OUTLAY CLEARING ACCOUNT		-\$1,547,400	COMPLETED/CLOSEOUT
AD011A	FY05 STREET LIGHT ASSET MAINTENANCE - NHS	This subproject provides a five-year contract for the preservation of electrical system assets for the Districts major streets and freeways, including maintenance of manholes, conduit and cable, streetlight poles, foundations and lighting fixtures. Also	\$1,913,476	COMPLETED/CLOSEOUT
AD012A	FY05 STREET LIGHT ASSET MANAGEMENT - STP	This subproject provides a five-year contract for the preservation of electrical system assets for the Districts major streets and freeways, including maintenance of manholes, conduit and cable, streetlight poles, foundations and lighting fixtures. Also	\$1,118,822	COMPLETED/CLOSEOUT
AD017A	FY06 CW STRLGH T UPGRADE MULTI-CIRCUIT	This project will provide funding for the upgrade of various multi-circuit streetlights throughout the District of Columbia. As of FY2013, new LED lights were installed in every new streetlight upgrade requests. Currently exercising option year 1. On 9/5/2	\$3,890,180	FY 2018
AD020A	FY11 CW STREETLIGHT ASSET MANAGEMENT	Streetlight Asset contract- 2nd Generation. This 5-year lighting contract to maintain and rehabilitate the District's aging electrical system.	\$3,398,565	FY 2017
AD201C	FY2002 STREETLIGHT MAINTENANCE & REPLACE	The Department is requesting \$5,000,000 in capital budget authority in FY 2002 to support Local Transportation Electrical System Improvements. This project renovates and replaces the Districts aging transportation electrical infrastructure that is not eli	\$1	COMPLETED/CLOSEOUT
AD304C	FY03 STREETLIGHT REPLACEMENT CONTRACT	This subproject provides a five-year contract for the preservation of electrical system assets for the Districts major streets and freeways, including maintenance of manholes, conduit and cable, streetlight poles, foundations and lighting fixtures. Also i	\$12,681,539	ONGOING
AD306C	PEDESTRIAN AND BICYCLE SAFETY ENHANCEMENTS	Improve safety for bicyclists and pedestrians through infrastructure improvements, public education and outreach, and improved enforcement	\$4,900,984	ONGOING
AD310C	SHERMAN STREET	Undergroup distribution street lighting system within Sherman Circle NW This project was performed by Babatunde Adeyemo	\$113,547	COMPLETED/CLOSEOUT
AF005A	ROCK CREEK TRAIL IMPROVEMENTS	Rehabilitate the Rock Creek Park Trail	\$471,032	FY 2017
AF024A	3301(29) BRENTWOOD RD TRSP STUDY	Conduct a planning and transportation management study to prepare for reconstruction of this roadway and determine what traffic calming measures should be implemented during construction. This project is being conducted in conjunction with the proposed re	\$515	COMPLETED/CLOSEOUT
AF028A	CIVIL RIGHTS / EEO COMPLIANCE MONITORING PROGRAM	This subproject will continue program development, administration and implementation of EEO procedures, including complaints and investigations; establishment of Title VI & ADA Standards and Procedures; conducting citywide ADA self-evaluations; designing	\$42,684	COMPLETED/CLOSEOUT
AF029A	FY05 PROGRESSIVE PARTNERS PROGRAM	This subproject will continue operation of an existing program. The OJT Supportive Services Program provides outreach, recruitment, counseling, testing, basic skills development, pre-vocational and vocational training, and placement assistance to individ	\$58,786	COMPLETED/CLOSEOUT
AF039A	CULTURAL TOURISM TRAIL SIGN MAINTENANCE	Maintenance of Heritage Trail signage	\$4,652	COMPLETED/CLOSEOUT
AF045A	AMBER PLAN PROGRAM ACTIVITIES IN THE DISTRICT OF COLUMBIA	This is a citywide project for the purpose of implementing systems and procedures that have been identified as necessary to incorporate various traveler information such as changeable message signs (CMS) in the issuance of child abduction or AMBER Alerts.	\$331,942	ONGOING
AF048A	FY07 ASSET INVENTORY - ADA	8888(399): Pilot Asset Inventory & ADA Compliance: Asset inventory and evaluation for ADA Compliance in the Golden Triangle	\$10,247	COMPLETED/CLOSEOUT
AF053A	FY06 DBE SUPPORTIVE SERVICES	The purpose of the project is to provide assistance and training to minorities and women to help them to compete, on an equal basis, for the award of contracts and subcontracts.	\$42,993	COMPLETED/CLOSEOUT
AF055A	FY06 CIVIL RIGHTS COMPLIANCE PROGRAM	This project is the DDOT Civil Rights Compliance Program. The project is for language services and ADA program goals, as well as training associated with Title VI, Title VII and ADA internally and externally. This project will continue program developmen	\$3,000	COMPLETED/CLOSEOUT
AF058A	PILOT BUSINESS OPPORTUNITY AND WORKFORCE DEVELOPMENT CENTER (BOWDC)	The purpose of this project is to operate the BOWDC, develop and expand new and existing programs related to the BOWDC, identify and recruit participants, and fully integrate DDOT's Disadvantaged Business Enterprises (DBE) and On-The-Job Training (OJT) Su	\$34,636	COMPLETED/CLOSEOUT
AF063A	FY08 BOWDC	The purpose of this project is to operate the BOWDC, develop and expand new and existing programs related to the BOWDC, identify and recruit participants, and fully integrate DDOT's Disadvantaged Business Enterprises (DBE) and On-The-Job Training (OJT) Su	\$44,236	COMPLETED/CLOSEOUT
AF066A	RECREATIONAL TRAIL MAINTENANE GRANTS	Programs associated with the Recreational Trails Program – a program established to develop and maintain recreational trails and trail-related facilities.	\$113,557	ONGOING
AF073A	METROPOLITAN BRANCH TRAIL - FORT TOTTEN	Design and build a piece of the Met Branch Trail between Brookland and Ft. Totten.	\$1,234,131	FY 2016
AF081A	DISTRICT STATEWIDE FREIGHT PLAN	Development of a District freight plan to enhance the safety and efficiency of goods movement	\$28,751	COMPLETED/CLOSEOUT
AF083C	16TH ST,NW BUS PRIORITY IMPRVS	Impelement Transit Improvements in this Corridor using the following tools; Transit Signal Priority, Curb Extensions and Real-time Bus Information Displays at bus stops	\$624,142	FY 2020
AF084C	GA AVE BUS PRIORITY IMPRVS	Impelement Transit Improvements in this Corridor using the following tools; Transit Signal Priority, Curb Extensions, Real-time Bus Information Displays at bus stops and Transit-Only lanes on GA Ave between Florida Ave NW and Barry PI NW.	\$3,316,489	FY 2016
AF085C	H ST/BENNING RD BUS PRIORITY IMPRVS	Implement Transit Improvements (Bus) on the H/Benning Corridor using the following tools; Real-time Bus Information Displays and Safety Improvements at Bus Stops (Emergency Call Boxes or other Similar Safety Improvements)	\$32,199	FY 2020
AF086C	WI AVE BUS PRIORITY IMPRVS	Impelement Transit Improvements in this Corridor using the following tools; Transit Signal Priority and Real-time Bus Information Displays at bus stops.	\$823,641	FY 2020
AF087C	TR BRIDGE TO K ST BUS PRIORITY IMPRVS	Implement technologies to improve Transit and traffic flow in the Downtown core along the TR Bridge to K St Corridor using the following; Transit Signal Priority, Traffic Signal Optimization and Uninterruptible Power Supplies (UPS) at critical traffic sig	\$380,395	FY 2025
AF088C	14TH ST BRIDGE TO K ST BUS PRIORITY IMPR	Implement technologies to improve Transit and traffic flow in the Downtown core along the 14th St Bridge to K St Corridor using the following; Transit Signal Priority, Traffic Signal Optimization and Uninterruptible Power Supplies (UPS) at critical traffi	\$1,189,105	FY 2016
AF089A	OXON RUN TRAIL	Improve access with in Oxon Run Park for non-motorized, bicycle and pedestrian transportation.	\$91,288	COMPLETED/CLOSEOUT
AF091A	KINGMAN AND HERITAGE ISLAND PARKS TRAIL MAINTENANCE	Conduct trail maintenance on unpaved trails on Heritage and Kingman Islands	\$73,150	FY 2017
AFT12A	KENILWORTH AVE & NANNIE HELEN BURROUGHS	Reconstruction of Kenilworth Avenue, NE from Foote Street to Lane Place; Bridges over Burroughs Avenue and Watt Branch.	\$1,329,242	COMPLETED/CLOSEOUT
AFT13A	RECONSTRUCTION OF KENILWORTH AVE, NE BRIDGE OVER NANNIE HELEN BURROUGHS ROADWAYS	Reconstruction of the Kenilworth Avenue Bridges over Nannie Helen Burroughs Avenue, and Kenilworth Avenue Bridges over Watts Branch.	\$7,565	COMPLETED/CLOSEOUT
AFT48A	SELECTED BRIDGES, VMS	Design of 11 new DMS signs at nine critical locations in the District	\$67,628	COMPLETED/CLOSEOUT
AFT62A	RECONSTRUCTION OF KENILWORTH AVE, NE BRIDGE OVER N.H. BURROUGHS ROADWAYS	Reconstruction of Kenilworth Ave from Foote Street to Lane Place	\$1,598,837	COMPLETED/CLOSEOUT
AW001A	SUITLAND PARKWAY-MARTIN LUTHER KING JR. AVE INTERCHANGE	Redevelopment of the South Capitol Street and the Anacostia Waterfront is a part of the Anacostia Waterfront Initiative. The interchange at Suitland Parkway and MLK is under development as part of the EIS currently being prepared for South Capitol Street	\$556,754	FY 2018

DC NUMBER	PROJECT TITLE	PROJECT DESCRIPTION	AVAILABLE FUNDS (1.29.2016)	Delivery Date
AW003A	ST. ELIZABETH'S TRANSPORTATION ACCESS STUDY	Multimodal transportation improvements associated with the redevelopment of St. Elizabeths East and West Campuses to provide better access to Congress Hights, Anacostia, and existing transportation infrastructure. Improvements may include:	\$21,399	COMPLETED/CLOSEOUT
AW011A	SOUTH CAPITOL STREET BRIDGE REPLACEMENT	Redevelopment of the South Capitol Street corridor is a part of the Anacostia Waterfront Initiative. Currently we are developing a RFP package for Phase 1 which will be given to the short listed teams. This will be a design-build project.	\$92,492,378	FY 2020
AW015A	RIVERWALK (KENILWORTH)	This segment is a critical piece to connect existing constructed trails in Bladensburg Maryland to the rest of the completed and planned Riverwalk segments--eventually linking to major regional trail segments	\$1,898,238	COMPLETED/CLOSEOUT
AW026A	RIVERWALK TRAIL FRP PEDESTRIAN & BICYCLE BRIDGES	Riverwalk Trail FRP Pedestrian & Bicycle Bridges project involves the construction of two pedestrian/bicycle bridges over CSX railroad, one on each (east and west) side of the Anacostia River. The west side bridge provides the missing link along the compl	\$1,163,411	COMPLETED/CLOSEOUT
AW027A	ST. E'S EAST CAMPUS	The District of Columbia Department of Transportation (DDOT) will be responsible for improvements to the transportation and utilities infrastructure to support the Stage 1 of the St. Elizabeths East Campus Redevelopment project. The project will be admini	\$2,419	COMPLETED/CLOSEOUT
AW031C	S CAPITOL ST/FREDERICK DOUGLASS BRIDGE	Replacement of S Capitol St/Federick Douglass Bridge	\$72,608,000	FY 2017
AW032A	ANACOSTIA KENILWORTH TRAILS (TIGER)	The Kenilworth Trail of the Anacostia Riverwalk comprises of a total of about 4 miles of trails starting north of the Benning road bridge on the east side of the Anacostia River and meanders along the river and the neighborhoods into Maryland. The District	\$9,035,912	FY 2016
BEE00C	BUS EFFICIENCY ENHANCEMENTS	PTSA is funding a number of projects that will improve bus efficiency in the District as well as two Circulator studies. A portion of the new Circulator National Mall Route implementation plan is being funded with the Bus Efficiency Enhancements as well	\$7,126,522	ONGOING
BR005C	H STREET BRIDGE	The H Street Bridge spans over the Amtrak corridor near Union Station in the downtown area of the District of Columbia. The bridge carries three lanes of H Street traffic in each direction over 1st Street and 2nd Street NE and over the Union Station rail	\$45,000,000	FY 2021
BRI01C	PEDESTRIAN BRIDGE	The Park side pedestrian Bridge Spans across the DC-295 Freeway and CSXT and WMATA railroad tracks at the Minnesota Metro Station. The project is to built with local funds and a contribution (up to \$3 million) from an adjacent developer.	\$17,144,808	FY 2018
CA301C	REPAIR AND MAINTAIN CURBS AND SIDEWALKS	This project is to provide for the restoration and rehabilitation of distressed sidewalks, curbs and gutters, minor drainage improvements, and temporary paving of new streets that are not eligible for federal aid highway funding. The way the work will be	\$6,402,349	ONGOING
CA302C	REPAIR/MAINTAIN CURBS/SIDEWALKS/ALLEYS	This project is to provide for the restoration and rehabilitation of distressed sidewalks and alleys, curbs and gutters, minor drainage improvements, and temporary paving of new streets that are not eligible for federal aid highway funding. The work will	\$60,204	COMPLETED/CLOSEOUT
CA303C	CULVERT REHABILITATION & REPLACEMENT	Under this funding account, DDOT will inspect, design, and rehabilitate or reconstruct Culverts throughout the District.	\$842,402	FY 2018
CA305C	LOCAL STREET REHAB SCOPING & DEVELOPMENT	This project provides funds for the development of scopes of work for city-wide local transportation improvements, including new construction and maintenance of local roadways, sidewalks, alleys, streetlights, street trees and treeboxes.	\$227	COMPLETED/CLOSEOUT
CAL16C	LOCAL SIDEWALK REHABILITATION-CITYWIDE	Citywide Sidewalk Repair/Replace and upgrading of wheelchair ramps, bus stops and overall accessibility	\$14,030,427	ONGOING
CB002A	TRAFFIC ACCIDENT REPORTING AND ANALYSIS SYSTEM (TARAS)	The Metropolitan Police Department's (MPD's) crash data is the primary source of the District's traffic safety information. In order to obtain this data, DDOT uses the Traffic Accident Reporting and Analysis System (TARAS) to link to the MPD database to	\$465,616	ONGOING
CB008A	HIGHWAY SAFETY IMPROVEMENT PROGRAM (HSIP)	This project will provide oversight, direction and system structure, highway facilities and operations, human and vehicle performances, and emergency vehicle services. Data will be collected and maintained. Since August 1994 DDOT has assumed the respons	\$15,989	COMPLETED/CLOSEOUT
CB029A	STP-8888(220) TRAFFIC SIGN INVENTORY UPGRADE & 8 ARTERIAL STREET STUDY	The project will improve traffic flow and enhance safety along federal routes and sugested corridors with improve signage.	\$66,331	FY 2016
CB031A	REPLACING AND UPGRADING ATTENUATORS & GUIDERAIL-IM	1. This project provides repair, replacement and upgrading of safety appurtenances on and off the Federal-Aid Highway System (NHS) that have been damaged by errant vehicles and replacement of units that do not meet the requirements of NCHRP (National Coop	\$618,746	COMPLETED/CLOSEOUT
CB032A	REPLACING AND UPGRADING ATTENUATORS & GUIDERAIL	1. This project provides repair, replacement and upgrading of safety appurtenances on and off the Federal-Aid Highway System (NHS) that have been damaged by errant vehicles and replacement of units that do not meet the requirements of NCHRP (National Coop	\$1,464,738	COMPLETED/CLOSEOUT
CB035A	CW HSIP DESIGN	Highway Safety Improvement Program (HSIP) Proposes engineering countermeasures at high hazard intersections to reduce crash frequency and severity	\$550,013	ONGOING
CB038A	TRAFFIC SAFETY IMPROVEMENTS - NEW YORK AVENUE & ECKINGTON PLACE, NE	This safety roadway improvement project provides short term relief to improve circulation and decrease in accidents.	\$701,145	COMPLETED/CLOSEOUT
CB039A	TRAFFIC SAFETY CONSTRUCTION- HSIP	Propose engineering countermeasures at high hazard intersections to reduce crash frequency and severity	\$3,141,622	ONGOING
CB045A	PAVEMENT SKID TESTING	The District Department of Transportation (DDOT) annually implements a skid testing sub-program under the Highway Safety Improvement Program (HSIP). Under this sub-program, consultants conduct pavement skid resistance testing at thirty (30) wet-pavement,	\$380,210	ONGOING
CB046A	TRAFFIC SAFETY DATA CENTER AT HOWARD UNIVERSITY	Traffic Data Center at Howard University - traffic data and analysis services via Howard University.	\$757,957	ONGOING
CB047A	TRAFFIC SAFETY ENGINEERING SUPPORT SERVICES	Consultant assistance with traffic engineering expertise in general and traffic safety engineering to work closely and provide day-to-day support to the Standard Safety and Quality Control Division.	\$3,804,953	ONGOING
CB048A	CW ROAD SAFETY AUDIT PROGRAM	City-Wide Safety Program	\$1,718,829	ONGOING
CBT52A	CITYWIDE, SAFETY IMPROVEMENT	The Traffic Division of DDOT proposes to use 80 percent Federal funding to remove streetlights from the median and install on the side. Removing streetlight from the medians to sides of the roadway will eliminate potential hazard from the section of the	\$309,896	COMPLETED/CLOSEOUT
CD013A	SOUTH CAPITOL STREET EIS	The FEIS will result in a preferred alternative for construction. The scope of design and construction will be determined after the R.O.D. is issued by FHWA.	\$1,454,875	COMPLETED/CLOSEOUT
CD014A	FRANCIS SCOTT KEY BRIDGE OVER THE POTOMAC RIVER (BRIDGE NO. 0007) -PHASE II	Preservation/rehabilitation of the Key Bridge substructure and superstructure.	\$54,208	FY 2018
CD015A	REPAINTING OF CHAIN BRIDGE OVER POTOMAC RIVER	This project replaces pin and hanger in three spans of the bridge and adds safety by installing Catcher beams at the pin and hanger locations. The project also repaints structural steel components and maintain concrete works on the deck and supports	\$240,643	COMPLETED/CLOSEOUT
CD018A	ASSET PRESERVATION OF TUNNELS IN THE DISTRICT OF COLUMBIA, NH	This is a performance-based contract that enables sustained preventive maintenance, rehabilitation and preservation of all of tunnel assets in DDOT inventory System. The principal objectives relative to public safety are: the maintenance of automated or	\$1,452,982	COMPLETED/CLOSEOUT
CD019A	ASSET PRESERVATION AND PREVENTIVE MAINTENANCE OF TUNNELS IN THE DISTRICT OF COLUMBIA CITYWIDE SURFACE TRANSPORTATION PROGRAM-STP	This is a performance-based contract that enables sustained preventive maintenance, rehabilitation and preservation of all of tunnel assets in DDOT inventory System. The principal objectives relative to public safety are: the maintenance of automated or	\$561,539	COMPLETED/CLOSEOUT
CD022A	REHAB OF SB 14TH ST BRIDGE OVER POTOMAC RIVER (BR # 1133)	This proposed project will improve the operational characteristics, public safety and structural condition of the existing bridge and extend the service life of the bridge and minimize further deterioration of the steel and concrete structures.	\$235	COMPLETED/CLOSEOUT
CD024A	FY05 CW FA CONSULTANT BRIDGE INSPECTION	Replacement or rehabilitation of deteriorated bridges is the Departments highest priority in the transportation element of the capital program because bridges are critical links in the Districts street and highway network. This project repairs, restores	\$248,131	COMPLETED/CLOSEOUT
CD026A	REHABILITATION OF THEODORE ROOSEVELT MEMORIAL BRIDGE AND APPROACHING RAMPS - PHASE 1	Phase 1 - Rehabilitation of the Theodore Roosevelt Memorial Bridge main spans and ramps (investigation and assessment)	\$1,702,824	FY 2018

DC NUMBER	PROJECT TITLE	PROJECT DESCRIPTION	AVAILABLE FUNDS (1.29.2016)	Delivery Date
CD032C	FY12 CITYWIDE OPEN END BRIDGE DESIGN CONSULTANT SERVICES	FY12 Citywide Open End Bridge Design Consultant Services	\$408,484	FY 2017
CD035A	SIX BRIDGES OVER WATTS BRANCH(0129,0204,0222,0132,0196,0199)	The purpose of this project is to rehabilitation and/or repair six (6) bridges over Watts Branch on 44th Street NE (Bridge No. 0129), 58th Street NE (Bridge No. 0132), 55th Street NE (Bridge 0196), 48th Place NE (Bridge No. 0199), Division Avenue NE (Brid	\$424,373	COMPLETED/CLOSEOUT
CD036A	FEDERAL AID PREVENTIVE MAINTENANCE AND EMERGENCY REPAIRS ON HIGHWAY STRUCTURES-BH	1. This project provides a two-year base contract with two option years for the performance of preventive maintenance activities and initiating emergency repairs on highway structures on an as needed basis. The work includes concrete deck repair, replacem	\$769,385	FY 2016
CD037A	27TH STREET BRIDGE OVER BROAD BRANCH, NW	Reconstruction of 27th Street Bridge over Broad Branch NW	\$277,355	COMPLETED/CLOSEOUT
CD042A	FEDERAL AID PREVENTIVE MAINTENANCE AND EMERGENCY REPAIRS ON HIGHWAY STRUCTURES-STP	1. This project provides a two-year base contract with two option years for the performance of preventive maintenance activities and initiating emergency repairs on highway structures on an as needed basis. The work includes concrete deck repair, replacem	\$342,629	FY 2016
CD044A	PROJECT MANAGEMENT - AWI	AWI Program Management	\$15,261,903	ONGOING
CD049A	PENNSYLVANIA AVE. NW BRIDGE OVER ROCK CREEK (BRIDGE NO. 0118)	Investigation and design for rehabilitation of the bridge superstructure and approach roadway improvements.	\$166,967	FY 2018
CD051A	REPLACEMENT OF KENILWORTH PEDESTRIAN BRIDGES	The project purpose is to replace three existing Pedestrian Bridges over Kenilworth Ave at Lane Pl(Bridge#0066), Nash St(Bridge#0067)and Douglas St(Bridge#0068) to improve pedestrian safety and mobility across DC-295 (Kenilworth Ave Freeway) including its	\$3,356,059	FY 2017
CD052A	SAFETY IMPROVEMENTS OF BENNING ROAD BRIDGES OVER KENILWORTH AVE, NE	DDOT is currently planning to reconstruct Benning Road between Oklahoma Avenue and Minnesota Avenue and the section of Minnesota Avenue between Benning Road and the Minnesota Avenue Metro Station. This project will also include addition of a streetcar li	\$331,749	FY 2017
CD053A	BRIDGE MANAGEMENT PROGRAM	This project provides funds to support the Bridge Management Program and to pay the annual Pontis license fee.	\$98,742	FY 2017
CD054A	H ST BRIDGE OVER RAILROADS NE, NORTH CAPITOL ST TO 3RD ST	Conduct environmental assessments. Prepare concept designs, design plans and specifications and construct documents for bridge replacement/rehab	\$1,014,036	FY 2017
CD055A	11TH STREET BRIDGES SE, REPLACE / RECONFIGURE	Replacement and reconfiguration of the existing deteriorating bridges and ramps at the Anacostia River crossing near 11th Street SE, connecting Anacostia Freeway and the Southeast Freeway. New freeway ramps east of the river will connect both directions o	\$256,522	COMPLETED/CLOSEOUT
CD056A	11TH STREET BRIDGE SE, REPLACE / RECONFIGURE	To replace existing structures with new structures and provide direct access from I-295 to Downtown DC (via I-395)	\$6,965,668	FY 2017
CD058A	REHABILITATION OF L'ENFANT PROMENADE	The maintenance of the three bridges and plaza at the L'Enfant Promenade (Bridges #517, 1114, and 1108).	\$142,172	COMPLETED/CLOSEOUT
CD060A	TRANSPORTATION DATA WAREHOUSE	The project is ongoing and a developer contract was executed, hardware procured and we are waiting for a contract to be awarded for Document Management System to Scan IPMA Bridge drawings at 55 M street	\$396,264	ONGOING
CD061A	FEDERAL AID PREVENTIVE MAINTENANCE AND EMERGENCY REPAIRS ON HIGHWAY STRUCTURES	1. This project provides a two-year base contract with two option years for the performance of preventive maintenance activities and initiating emergency repairs on highway structures on an as needed basis. The work includes concrete deck repair, replacem	\$135,854	ONGOING
CD062A	FY10 CONSULTANT BRIDGE INSPECTION	Consultant inspection of the District's bridges, tunnels and sign structures.	\$1,483,780	ONGOING
CD063A	FY12-FY16 ASSET PRESERVATION & PREVENTITIVE MAINTENANCE OF TUNNELS	This is a performance-based contract that enables sustained preventive maintenance, rehabilitation and preservation of all of tunnel assets in DDOT inventory System. The principal objectives relative to public safety are: the maintenance of automated or n	\$4,675,216	ONGOING
CD064A	ASSET PRESERVATION OF TUNNELS - NH	This is a performance-based contract that enables sustained preventive maintenance, rehabilitation and preservation of all of tunnel assets in DDOT inventory System. The principal objectives relative to public safety are: the maintenance of automated or n	\$1,017,043	COMPLETED/CLOSEOUT
CD066A	REPLACEMENT OF 31ST STREET BRIDGE, NW OVER C&O CANAL (GEORGETOWN)	Replacement of 31st Bridge over the C&O canal and approaching roadways.	\$637,013	FY 2017
CD503A	PENNSYLVANIA AVE BRIDGE OVER THE ANACOSTIA RIVER (JOHN PHILIP SOUSA MEMORIAL BRIDGE) BRIDGE NO. 54		\$265,266	COMPLETED/CLOSEOUT
CDT20A	REHABILITATION OF WISCONSIN AVENUE BRIDGE OVER THE CHESAPEAKE & OHIO CANAL & TRAFFIC MAINTENANCE ON THE 31ST ST BR OV C & O CANAL	This project repairs, restores and replaces deteriorated, unsafe bridge structures, tunnels and elevated highways facilities on and off the federal aid highway system.	\$43,645	COMPLETED/CLOSEOUT
CDT22A	REHABILITATION OF THOMAS JEFFERSON STREET BRIDGE, 29TH STREET BRIDGE AND 30TH STREET BRIDGE OVER C & O CANAL	This project reconstructs all three bridges (superstructure and substructure). In addition to replacing the deteriorated bridge structures, utilities will be supported under the new bridges.	\$1,967,007	COMPLETED/CLOSEOUT
CDT28A	PEDESTRIAN BRIDGE OVER KW AVE AT DOUG STREET , RECON PEDESTRIAN BRIDGE		\$253,534	COMPLETED/CLOSEOUT
CDT30A	RECONSTRUCTION OF HUNT PLACE BRIDGE OVER WATTS BRANCH, REMOVE REPLACE BRIDGE DECK SUB.	This project repairs, restores and replaces deteriorated, unsafe bridge structures, tunnels and elevated highways facilities on and off the federal aid highway system.	\$32,475	COMPLETED/CLOSEOUT
CDT50A	REHABILITATION OF SOUTHEAST FREEWAY 2ND ST. TO 11TH ST. BR#S, 1400, 1401, & 1402	This project repairs, restores and replaces deteriorated, unsafe bridge structures, tunnels and elevated highways facilities on and off the federal aid highway system.	\$76,166	COMPLETED/CLOSEOUT
CDT51A	REHAB OF 9TH ST BRIDGE OVER SW FREEWAY	Rehabilitation of 9th Street Bridge and girder Repairs of 10th Street bridge over southwest freeway.	\$695,724	COMPLETED/CLOSEOUT
CDT89A	SOUTH DAKOTA AVE. NE OVER RAILROAD BRIDGE, REMOVE/REPLACE PCC DECK AND GEN	This project repairs, restores and replaces deteriorated, unsafe bridge structures, tunnels and elevated highways facilities on and off the federal aid highway system.	\$15,836	COMPLETED/CLOSEOUT
CDT91A	REHABILITATION OF 11TH STREET BRIDGE S.W. OVER RAILROAD (BRIDGE NO. 517)	This project rehabilitates and reconstructs the 11th Street Bridge, adjacent ramps, roadway approaches, and intersection.	\$10,877	COMPLETED/CLOSEOUT
CDT96A	REHABILITATION OF ATLANTIC ST SE BRIDGE, REMOVE/REPLACE PCC DECK	This project repairs, restores and replaces deteriorated, unsafe bridge structures, tunnels and elevated highways facilities on and off the federal aid highway system.	\$9,720	COMPLETED/CLOSEOUT
CDT97A	REHABILITATION OF NEW YORK AVE., REMOVE REPLACE PCC DECK AND GEN.	This project repairs, restores and replaces deteriorated, unsafe bridge structures, tunnels and elevated highways facilities on and off the federal aid highway system.	\$349,352	COMPLETED/CLOSEOUT
CDT80A	EASTERN AVE. BRIDGE NE OVER KENILWORTH REPLACEMENT	Total replacement of superstructure and substructure by accelerated construction method. This bridge has been hit many times because of low clearance and under this contract the clearance is being raised.	\$6,921	COMPLETED/CLOSEOUT
CDT86A	REHABILITATION OF K, MASSACHUSETTS, AND H BRIGES OVER THE CENTER LEG FREEWAY, AND ELECTRICAL-MECHANICAL UPGRAGE OF OF THE AIR RIGHTS TUNNEL	This project repairs, restores and replaces deteriorated, unsafe bridge structures, tunnels and elevated highways facilities on and off the federal aid highway system. The replacement or rehabilitation of deteriorated bridges are the Departments highest	\$1,591,808	COMPLETED/CLOSEOUT
CDT87A	K ST. NW OVER CENTER LEG #1143, REHABILITATION	This project repairs, restores and replaces deteriorated, unsafe bridge structures, tunnels and elevated highways facilities on and off the federal aid highway system. The replacement or rehabilitation of deteriorated bridges are the Departments highest	\$548,808	COMPLETED/CLOSEOUT
CDT88A	REHAB OF CONNECTICUT AVE BRIDGE OVER KLINGLE VALLEY (BR.# 27)	This project repairs, restores and replaces deteriorated, unsafe bridge structures, tunnels and elevated highways facilities on and off the federal aid highway system. The replacement or rehabilitation of deteriorated bridges are the Departments highest	\$386,395	COMPLETED/CLOSEOUT
CDTC2A	REHAB OF BRIDGE NO. 40-1 35TH ST, NE BRIDGE OVER EAST CAPITOL ST	This project repairs, restores and replaces deteriorated, unsafe bridge structures, tunnels and elevated highways facilities on and off the federal aid highway system. The replacement or rehabilitation of deteriorated bridges are the Departments highest	\$52,155	COMPLETED/CLOSEOUT
CDTC4A	RECONSTRUCTION OF 16TH ST. BRIDGE OVER MILITARY RD. NW,	This project replaces the existing reinforced concrete rigid frame bridge, abutments and adjoining wingwalls with prefabricated hunched and straight steel girders, deck slab, abutment and wingwalls. The Accelerated Bridge Construction System (ABC System)	\$3,061,215	COMPLETED/CLOSEOUT
CDTC5A	RECONSTRUCTION OF 16TH ST, NW ROADWAYS, RAMPS, MEDIAN BARRIER AND STREETLIGHT IMPROVEMENTS ON MILITARY ROAD	This project installs a stone faced concrete barrier median on Military Rd from the 14th Street intersection to Oregon Ave intersection, NW to provide improved traffic mobility and safety. The project also improves street lighting on the same stretch of M	\$1,198,501	COMPLETED/CLOSEOUT
CDTD4A	NEW HAMPSHIRE AVE BRIDGE NE OVER RR, REHAB	This project repairs, restores and replaces deteriorated, unsafe bridge structures, tunnels and elevated highways facilities on and off the federal aid highway system.	\$1,031,336	COMPLETED/CLOSEOUT
CDTE0A	DESIGN/BUILD OF 9TH STREET BRIDGE OVER NEW YORK AVENUE AND AMTRAK, N.E.	This project repairs, restores and replaces deteriorated, unsafe bridge structures, tunnels and elevated highways facilities on and off the federal aid highway system.	\$185,858	COMPLETED/CLOSEOUT

DC NUMBER	PROJECT TITLE	PROJECT DESCRIPTION	AVAILABLE FUNDS (1.29.2016)	Delivery Date
CDTE3A	14TH ST CORRIDOR SIGNAGE IMPROVEMENTS [INTERSTATE 395 SIGNING IMPROVEMENTS PROJECT] (DDOT/EFLHD)	Installation, modification, removal and replacement of traffic signs (roadside and overhead), cantilever sign structures, and overhead sign bridges to meet the current standards.	\$57,712	COMPLETED/CLOSEOUT
CDTE5A	REHAB OF CONNECTICUT AVE, NW DEVONSHIRE PL-MACOMB ST (BR. # 27 ROADWAYS)	This project repairs, restores and replaces deteriorated, unsafe bridge structures, tunnels and elevated highway facilities on and off the federal aid highway System.	\$631,477	COMPLETED/CLOSEOUT
CDTE7A	REHAB OF 35TH ST, NE ROADWAYS AND EAST CAPITOL ST SERVICE ROADS	This program provides for the restoration and rehabilitation of distressed streets and highways pavements through resurfacing improvements on the federal aid highway system.	\$268,200	COMPLETED/CLOSEOUT
CDTE8A	ROADWAYS NEW HAMPSHIRE AVE, NE BRIDGE OVER CSX AND WMATA TRACKS	This program provides for the restoration and rehabilitation of distressed streets and highways pavements through resurfacing improvements on the federal aid highway system.	\$276,266	COMPLETED/CLOSEOUT
CDTF3A	REHAB OF SOUTH DAKOTA AVE BRIDGE OVER CSX RR, ROADWAYS	The bridge beams have corroded and the concrete pier caps have deteriorated so much which warrant a rehabilitation of the bridge.	\$64,689	COMPLETED/CLOSEOUT
CDTF9A	REHAB OF K ST/H ST/MASSACHUSETTS AVE NW BRIDGES OVER CENTER LEG FREEWAY -- APPROACH ROADWAYS		\$506,825	COMPLETED/CLOSEOUT
CE301C	FY03 PAVEMENT MARKING & TRAF CALM IMPROV	This program provides for the restoration and rehabilitation of distressed streets and highway pavements through resurfacing improvements on local roads not eligible for federal aid. Further, this citywide project will provide for pavement markings to in	\$7,143	COMPLETED/CLOSEOUT
CE302C	FY03 ST REPAIR & MGMT EQUIP/TECH IMPROV	This program provides for the purchase of Street Repair Equipment and technology improvements essential to the (in-house) restoration and rehabilitation of distressed streets and highway pavements through resurfacing improvements on local roads not eligi	\$1,307,491	ONGOING
CE303C	STREET REPAIR MATERIALS	This project will provide the needed material to address all aspects of streets repair and maintenance thus extending the useful life of our crucial network of local roadways and alleys throughout the District. The material is designated for local streets	\$448,492	ONGOING
CE304C	STREET SIGN IMPROVEMENTS	This project will provide the needed supplies, materials and equipment to address all aspects of local streets and parking sign repair and maintenance, including the installation of new signage. Without adequate funding the Sign shop and its specialized e	\$1,217,940	ONGOING
CE307C	BRIDGE OPERATION AND MAINTENANCE	This project funds in house DC Forces staff salaries, equipment and materials to apply preventive maintenance measures and activities citywide area bridges and truck scale maintenance	\$3,006,615	ONGOING
CE308C	CONCRETE, ASPHALT AND BRIDGE MAINTENANCE	Project should be titled Resurfacing, Repair and Maintenance of Local Streets & Bridges. This project funds DC forces salaries, equipment and supplies for In house DDOT crew to perform milling and paving/resurfacing of local streets. Includes funding por	\$37,284	ONGOING
CE309C	MASONRY AND CONCRETE MAINTENANCE	This project includes sidewalk maintenance & repair work. This project should be titled Resurfacing, Repair and Maintenance of Local Sidewalks. Project funds DC forces salaries, equipment and supplies for In house DDOT crew performing installation rep	\$1,924,365	ONGOING
CE310C	STREET AND ALLEY MAINTENANCE	This project funds in-house force salaries, equipment and supplies for DC Forces to response to safety repairs & patching including preventive maintenance, patching and some resurfacing of local alleys. Includes the installation of speed humps, preventive	\$6,962,631	ONGOING
CE311C	HAZARDOUS ROAD SEGMENTS IMPROVEMENTS	Improve pedestrian and bicycle access on East Capitol Street between 42nd Street and Southern Avenue, Maryland Avenue NE between 2nd and 15th Streets	\$1,135,911	FY 2017
CE312C	PUERTO RICO AVE NOISE AND VIBRATIONS BAR		\$250,000	FY 2016
CE503C	UNION MARKET INFRASTRUCTURE		\$132	COMPLETED/CLOSEOUT
CEL21C	ALLEY REPAIRS AND IMPROVEMENTS	Of the 367 miles of alleys in the District, 30% of are in poor condition and 37% are in fair condition. DDOT typically funds alley repairs and improvements out of its Local Roads Construction and Maintenance Fund (LRCMF), where they compete with street r	\$8,110,792	ONGOING
CEL23C	DHCD MOU WARD 7/8	Pavement Restoration in wards 7&8 with DHCD funds	\$41,698	COMPLETED/CLOSEOUT
CETG6A	VARIOUS, FY97 7TH FEDERAL AID RESURFACING		\$63,694	COMPLETED/CLOSEOUT
CET12A	VARIOUS, FY-98 5TH FEDERAL AID RESURFACING	This program provides for the restoration and rehabilitation of distressed streets and highway pavements through resurfacing improvements on the Federal-aid Highways system.	\$518,237	COMPLETED/CLOSEOUT
CETK7A	FY2000 2ND FEDERAL AID RESURFACING, 20TH ST NW 13TH ST NW 9TH ST.		\$1,890	COMPLETED/CLOSEOUT
CG311C	TREE PRUNING	Pruning of right of way trees through out the District. Close out direction required.	\$1,389,552	COMPLETED/CLOSEOUT
CG312C	TREE REMOVAL	Tree Removal services citywide for dead, dying and diseased trees.	\$1,283,291	COMPLETED/CLOSEOUT
CG313C	PEST MANAGEMENT	Plant Health services citywide to include female ginkgo spaying, dutch elm disease control and other health services.	\$14,023,202	ONGOING
CG314C	TREE PLANTING	Tree planting citywide in the right of way mainly the street side	\$6,727,948	ONGOING
CI001A	FY01 HOT THERMOPLASTIC PAVEMENT MARKING, PAVEMENT MARKING CONTRACT.		\$230	COMPLETED/CLOSEOUT
CI020A	FY04 TRAFFIC SIGNAL CONSTRUCTION CONTRACT; NHS ROUTES	Install new and modify existing traffic signals on the National Highway System	\$98,899	COMPLETED/CLOSEOUT
CI022A	VIRTUAL TRAFFIC MANAGEMENT CENTER RELOCATION	This project will consist of the implementation of a Situation Room at DDOT Headquarters at 55 M St. SE Washington, District of Columbia. The area set aside for this activity has been designed and wired for the equipment needed to operate an effective a	\$95,808	ONGOING
CI026C	TRAFFIC MANAGEMENT OPERATIONS @ REEVES CENTER	DDOT is requesting federal funds over six years to pay for the salary of in-house staff associated with transportation operations and ITS functions and a service contract for TMC equipment maintenance and software integration.	\$573,650	ONGOING
CI027C	TRAFFIC SIGNAL CONSULTANT DESIGN	The project will support the Traffic Signal Design Groups of DDOT / TOA providing traffic signal designs for the city's traffic signal system.	\$635,395	ONGOING
CI028C	TRAFFIC SIGNAL SYSTEMS ANALYSIS AND MGMT.	To provide Transportation planning/ engineering studies, Traffic signal warrant studies, Traffic safety and operational analysis, pedestrian and bicyclist needs, and geometric conditions analysis in order to support Traffic Signal Design Groups of the DDO	\$1,171,461	ONGOING
CI032C	TRAFFIC MANAGEMENT CENTER (TMC) AND ROP SPARE PARTS	TMC Spare parts funds the necessary hardware and software and IT equipment to ensure reliable operations of traffic management center.	\$347,117	COMPLETED/CLOSEOUT
CI034A	FY08 CW THERMOPLASTIC PAVEMENTS MARKINGS	To provide installation of new pavement markings and refurbishment on all STP and NHS routes throughout the District of Columbia.	\$261,108	COMPLETED/CLOSEOUT
CI035A	ITS ON CALL TECHNICAL SUPPORT SERVICES	Identify, study and design elements of Intelligent Transportation System technology for implementation on District of Columbia highways and primary routes.	\$1,552,430	ONGOING
CI040A	TRAFFIC SIGNAL BULB (LED) REPLACEMENT NHS	waiting attributes for option year one Replace Traffic and Pedestrian Signal LED Modules at all signalized intersections on the National Highway System	\$719,904	FY 2016
CI041A	TRAFFIC SIGNAL BULB (LED) REPLACEMENT STP	Replace Traffic and Pedestrian Signal LED Modules at all signalized intersections on the Surface Transportation System.	\$23,113	COMPLETED/CLOSEOUT
CI043A	IMPLEMENTATION OF FREEWAY TRAFFIC MANAGEMENT SYSTEM		\$1,001,825	FY 2017
CI045A	DYNAMIC MESSAGE SIGN SYSTEM CONSTRUCTION	DDOT will build 11 new Dynamic Message Signs at nine locations for incident management, traffic control and evacuation management purposes. The construction is expected to start in July of 2012.	\$903,838	COMPLETED/CLOSEOUT
CI046A	FY08 TRAFFIC SIGNAL MAINTENANCE - NHS	This projects mission is to modify and improve vehicular and pedestrian traffic control systems such as traffic signals, channelization, signs, pavement markings, and other traffic control measures on and off the Federal-aid Highway System.	\$635,987	COMPLETED/CLOSEOUT
CI047A	FY08 TRAFFIC SIGNAL MAINTENANCE - STP	This projects mission is to modify and improve vehicular and pedestrian traffic control systems such as traffic signals, channelization, signs, pavement markings, and other traffic control measures on and off the Federal-aid Highway System.	\$747,438	COMPLETED/CLOSEOUT
CI053A	WEIGH-IN-MOTION	In 2009, the International Road Dynamics, Inc (IRD) was issued a two year contract to maintain the two WIM stations on New York Avenue and I-295. IRD conducts system calibration, system validation and data collection, poll and transmit the maintenance dat	\$179,299	ONGOING

DC NUMBER	PROJECT TITLE	PROJECT DESCRIPTION	AVAILABLE FUNDS (1.29.2016)	Delivery Date
CI055A	TRAFFIC SIGNAL OPTIMIZATION	Create a Citywide Traffic Signal Optimization Model and retune traffic signals by partitioning the City into six zones (approximately 250-300 signals in each zone) to improve the efficiency of the transportation network while balancing the competing needs	\$3,450,847	ONGOING
CI056A	TRAFFIC SIGNAL UNINTERRUPTIBLE POWER SUPPLY (UPS) SYSTEM	Install battery based, uninterruptible power supply for critical signalized intersections. This system would automatic transfer from electrical power to battery back-up power at the sign of power loss. This system would eliminate the need and the labor	\$764,351	ONGOING
CI060A	DEVELOPMENT OF ADVANCED TRANSPORTATION MANAGEMENT SYSTEM	DDOT will build next-generation Advanced Transportation Management System for incident management, traffic operation and special event management.	\$2,228,746	ONGOING
CI063A	FY-2010 CITY-WIDE TRAFFIC SIGNAL CONSTRUCTION CONTRACT	Install new and modify existing traffic signals on the National Highway System and on the Surface Transportation System.	\$5,370,017	ONGOING
CIR14C	CIRCULATOR BUSES	DDOT will procure new buses for the DC Circulator to replace vehicles that are reaching the end of their useful life. The current plan calls for an initial order of 10 vehicles from the General Services Administration (GSA) Schedule. Additional vehicle	\$26,872,429	ONGOING
CIRBGC	DBOM CIRCULATOR BUS GARAGE	DDOT is conducting a site selection process to identify sites that meet the needs for this facility. The Delivery Date is for the completion of the site selection process.	\$2,056,000	FY 2017
CIRFLC	CIRCULATOR FLEET REFURBISHMENT		\$1,000,000	ONGOING
CIT15C	REFLECTOR/TRAFFIC PAINT PAVEMENT MARKING		\$102	COMPLETED/CLOSEOUT
CITA9A	TRAFFIC SIGNAL SYSTEMS SOFTWARE AND HARDWARE MAINTENANCE	Ongoing central and local traffic controller software support.	\$251,999	COMPLETED/CLOSEOUT
CITB1A	CITYWIDE, SIGNAL CONTROLLER UPGRADE	This project's mission is to modify and improve vehicular and pedestrian traffic control systems such as traffic signals, channelization, signs pavement markings, and other traffic control measures on and off the Federal-aid Highway system.	\$894	COMPLETED/CLOSEOUT
CIVWAR	CIVAL WAR MEMORIAL PROJECT		-\$332,187	COMPLETED/CLOSEOUT
CK001A	RECONSTRUCTION OF BRENTWOOD ROAD NE 9TH ST, RECONSTRUCTION ROADWAY WIT PCC	This project reconstructs streets on the Federal-aid Highway System. Total roadway reconstruction is required when the highway pavement has reached the end of its useful life and can no longer be resurfaced.	\$3,466	COMPLETED/CLOSEOUT
CK002A	RECONSTRUCTION OF 1ST ST, NE K STREET TO NEW YORK AVE	This project reconstructs streets and highways on the Federal-aid Highway System. Total roadway reconstruction is required when the highway pavement has reached the end of its useful life and can no longer be resurfaced.	\$2,352,260	COMPLETED/CLOSEOUT
CK010A	DOWNTOWN B.I.D. STREETScape AND STREETLIGHT PLAN	This project reconstructs and upgrades street lights system on the Federal-aid Road System. In addition to lighting, there would be some sidewalks, wheelchair ramps, trees, trash can bins upgrades and some repair to the disturbed surfaces.	\$636	COMPLETED/CLOSEOUT
CK026A	REHABILITATION OF COLUMBUS PLAZA	This plan is to develop an ITC project at this location to improve safety for pedestrians, better traffic flow and enhance the landscape in the islands.	\$2,131,193	COMPLETED/CLOSEOUT
CK301C	FY03 ADV DES & PROJ/CONT DEV & CLOSEOUT	The purpose of this project is to provide transportation improvements to targeted areas as a means for stimulating private-sector activity and to improve the quality of life in District neighborhoods for its residents. This project will strategically tar	\$177	COMPLETED/CLOSEOUT
CKT59A	REHABILITATION OF NEW YORK AVENUE, NE OVER SOUTH DAKOTA AVENUE (BR#242)	This project reconstructs streets and highways on the Federal aid highway system. Total roadway reconstruction is required when the highway pavement has reached the end of its useful life and can no longer be resurfaced.	\$52,927	COMPLETED/CLOSEOUT
CKT63A	RECONSTRUCTION OF 11TH ST NW L-O STS	Total reconstructin.	\$927,916	COMPLETED/CLOSEOUT
CKT69A	RECONSTRUCTION OF BLADENBURG RD NE MT OLIVET , RECONSTRUCT THE ROADWAY WITH PCC	This project reconstructs streets and highways on the Federal aid highway system. Total roadway reconstruction is required when the highway pavement has reached the end of its useful life and can no longer be resurfaced.	\$485,793	COMPLETED/CLOSEOUT
CKT74A	RECONSTRUCTION OF 16TH STREET, N.W., ALASKA AVENUE TO PRIMROSE ROAD	This project reconstructs streets and highways on the Federal aid highway system. Total roadway reconstruction is required when the highway pavement has reached the end of its useful life and can no longer be resurfaced.	\$177,423	COMPLETED/CLOSEOUT
CKT76A	RECONSTRUCTION OF 18TH ST, NW FLORIDA-MASSACHUSETTS AVES	This project reconstructs streets and highways on the Federal aid highway system. Total roadway reconstruction is required when the highway pavement has reached the end of its useful life and can no longer be resurfaced.	\$908,716	COMPLETED/CLOSEOUT
CKT77A	MACARTHUR BLVD, RECONSTRUCTION		\$34,672	COMPLETED/CLOSEOUT
CKT83A	RECONSTRUCTION OF F ST, NW 17TH TO 23RD STREETS	This project reconstructs streets and highways on the Federal aid highway system. Total roadway reconstruction is required when the highway pavement has reached the end of its useful life and can no longer be resurfaced.	\$1,810,383	COMPLETED/CLOSEOUT
CKT89A	RENO RD, NW MIL TO NEBR., PE FOR RECONSTRUCTION	This project reconstructs streets and highways on the Federal aid highway system. Total roadway reconstruction is required when the highway pavement has reached the end of its useful life and can no longer be resurfaced.	\$477,437	COMPLETED/CLOSEOUT
CKT96A	HISTORIC STREET ALLEYS, TO DESIGN RECONSTRUCT STREETS	The District of Columbia Department of Transportation proposes to initiate a new federally funded Historic Street & Alley Program for streets and alleys that are not on the federal-aid highway system. Federal Enhancement funds will be used to preserve st	\$2,613,840	COMPLETED/CLOSEOUT
CKT84A	RECONSTRUCTION OF BENNING RD 14TH NE TO OKLAHOMA ST NE (GREAT STREET)	This project reconstructs streets and highways on the Federal aid highway system. Total roadway reconstruction is required when the highway pavement has reached the end of its useful life and can no longer be resurfaced.	\$445,225	COMPLETED/CLOSEOUT
CKT85A	RECONSTRUCTION OF BENNING ROAD, NE FROM 39TH STREET AVENUE TO 42ND STREET	This project reconstructs streets and highways on the Federal aid highway system. Total roadway reconstruction is required from 39th St. to 42nd St., the highway pavement has reached the end of its useful life and can no longer be resurfaced. The project	-\$67,499	COMPLETED/CLOSEOUT
CKTC0A	KLINGLE ROAD PRELIMINARY DESIGN	This project includes preliminary design for Klingle Rd, any necessary environmental remediation, and construction of the projects.	\$197	COMPLETED/CLOSEOUT
CKTC1A	EAST CAPITOL STREET FROM 19TH STREET TO, RECONSTRUCTION OF EAST CAPITOL STREET	This project reconstructs streets and highways on the Federal aid highway system. Total roadway reconstruction is required when the highway pavement has reached the end of its useful life and can no longer be resurfaced.	\$298,975	COMPLETED/CLOSEOUT
CM023A	BIKE SHARING	Capital Bikeshare is a bicycle sharing program that allows for point-to-point bike trips in the District. It currently features 137 stations with 1385 bikes in all 8 Wards of the city.	\$5,402,577	ONGOING
CM031A	PEDESTRIAN MANAGEMENT AND SAFETY PROGRAM	Increase pedestrian access and safety by review transportation and real estate plans, outreach and education to pedestrians and motorists, training staff and consultants on pedestrian issues.	\$333,426	COMPLETED/CLOSEOUT
CM055A	SAFE ROUTES TO SCHOOL - ARRA SIDEWALKS	Install missing sidewalks and make other improvements near schools. This project is awaiting close-out.	\$1,387	COMPLETED/CLOSEOUT
CM074A	DISTRICT TDM PROGRAM (GODCGO)	The District TDM Program is an ongoing initiative of the District Department of Transportation that provides employees, residents and visitors with the education and assistance they need to make more informed choices about their daily travel. Program eff	\$1,234,362	ONGOING
CM077A	DDOT CLIMATE CHANGE/AIR QUALITY PLAN	Funds will be added for staff charges for activities to help DDOT play a vital role in identifying climate change mitigation and adaptation measures for the District's transportation network, which would allow for sustainable transportation solutions.	\$256,822	ONGOING
CM081A	STREETCAR NEPA ANACOSTIA EXTENSION	FTA Project number: DC-95-X010-00Anacostia ILS Phase II Ext, NEPA\$1,156,320 - project cost\$96,360 - PS100% CMAQ funded	\$580,825	COMPLETED/CLOSEOUT
CM086A	SAFE ROUTES TO SCHOOL - ONGOING	Increase walking and bicycling to school and associated safety through planning, engineering, education, and enforcement.	\$987,052	ONGOING
CM087A	FY14 SAFE ROUTES TO SCHOOL	Increase walking and bicycling to school and associated safety through planning, engineering, education, and enforcement.	\$2,906,967	ONGOING
CWAP1J	LOW IMPACT DEVELOPMENT (LID)	Construct projects to demonstrate Low Impact Development (LID) at 4 sites: East Beach Drive NW, Erie St SE, Fitch Pl NE, and Q St & Ft Dupont SE	\$683,078	COMPLETED/CLOSEOUT
CWFGAP	GREEN ALLEYS (CLEAN WATER ACT SRF)		\$2,171,938	FY 2018
CWFGIE	GREEN INFRASTRUCTURE ENHANCEMENTS		\$312,400	COMPLETED/CLOSEOUT
CWSFRA	GREEN ALLEYS	Usign ARRA funds from USEPA via DDOE, DDOT will reconstruct four alleys within the Watts Branch Watershed using Permeable Concrete	\$25,047	COMPLETED/CLOSEOUT
CWSFRD	IMPERVIOUS SURFACE REDUCTION	ARRA Funded by EPA through DDOE interdistrict transfer of State Revolving Funds to remove impervious surfaces along the right of way located in the Combined Sewer Area and replace with new soil for trees or sod. It creates new green space in areas where	\$90,132	COMPLETED/CLOSEOUT
CWSTLT	LED LIGHTING	Lighting Study to find energy efficient light source for District's street light system	\$7,815	COMPLETED/CLOSEOUT
DPRDOT	INSTALL PARK LIGHTS	Construction completed 2011.	\$61,923	COMPLETED/CLOSEOUT
ED017A	MINNESOTA AVE, N.E./BENNING ROAD, NE AND SE TRANSPORTATION STUDY	Conduct a planning and transportation management study to prepare for reconstruction of this roadway and determine what traffic calming measures should be implemented for economic development initiatives.	\$2,505	COMPLETED/CLOSEOUT

DC NUMBER	PROJECT TITLE	PROJECT DESCRIPTION	AVAILABLE FUNDS (1.29.2016)	Delivery Date
ED024A	TAKOMA TRANSPORTATION IMPROVEMENTS FA AND LOCAL STREETS	Implementation of the long-term recommendations from the Takoma Transportation Study	\$22,902	COMPLETED/CLOSEOUT
ED028A	RECONSTRUCTION OF SOUTHERN AVE SE - PHASE 1 (BETWEEN S. CAPITOL ST AND BARNABY RD) INCLUDING REPLACEMENT OF THE BRIDGE (NO. 64) OVER WINKLE DOODLE BRANCH AND IMPROVE HYDRAULIC CONDITION FOR THE EXISTING BARNABY RUN CHANNEL - FINAL DESGN FOR CONSTRUCTION A	The purpose of this project is to improve vehicular and pedestrian safety along Southern Ave SE corridor from S. Capitol St to 23rd St - the current phase 1, is from S. Capitol St to Barnaby St. Besides reconstruction of the Southern Ave SE. the project a	\$3,981,088	FY 2017
ED035A	GREAT STREETS PENNSYLVANIA AVE, PHASE II	This project is the second phase of the Great Streets Pennsylvania Ave Project which includes the design and construction of Pennsylvania Ave from the Sousa Bridge to 27th Street including the redevelopment of Twining Square.	\$3,140	COMPLETED/CLOSEOUT
ED036A	SKYLAND TRANSPORTATION STUDY GOOD HOPE RD/NAYLOR RD/ALABAMA AVE		-\$44,236	COMPLETED/CLOSEOUT
ED047A	MIDDLE GEORGIA AVE, GREAT STREETS	Reconstruction of Middle Georgia Avenue Great Street NW from Otis Place to Webster Street	\$742,119	COMPLETED/CLOSEOUT
ED061A	PENNSYLVANIA AVE., SE, FROM 200 FEET WEST OF 27TH STREET TO SOUTHERN AVENUE	The \$25M Pennsylvania Avenue Great Streets Project extends two miles east of the Sousa Bridge, beginning 200 feet west of 27th Street, SE and ending at Southern Avenue, SE. The construction completion was originally anticipated for December 12, 2012; comp	\$1,212,064	COMPLETED/CLOSEOUT
ED062A	NANNIE HELEN BURROUGHS AVE. GREAT STREET IMPROVEMENTS	Construct improvements to sidewalks, curbs, gutters, streets, tree boxes, replace street trees and install other streetscape elements. Construct facilities to improve reliability and safety of transit services, including transit lanes, provide bicycle l	\$565,308	COMPLETED/CLOSEOUT
ED063A	REVITALIZATION OF MARTIN LUTHER KING JR. AVE., SE - GREAT STREETS PROJECT	Conduct traffic assessments and provide public review and comment of proposed streetscape design elements. Conduct environmental assessments. Prepare concept designs, design plans and specifications and construct improvements to sidewalks, curbs, gutte	\$347,561	COMPLETED/CLOSEOUT
ED064A	REVITALIZATION OF MINNESOTA AVE. NE FROM "A" STREET TO SHERIFF RD.	Revitalization of Minnesota Avenue, NE from A Street, SE to Sheriff Road, NE. Phase 1 from A Street, SE to mid-block between Dix Street and Benning Road will be constructed first. Phase 2 from the mid-block to Sheriff Road will be constructed as second	\$321,184	FY 2017
ED070A	RECONSTRUCTION OF U ST, NW	Phase I: U Street from 9th street to 14th street is resurfacing of roadway, upgrading sidewalk, street lighting, traffic signal and landscape. Phase II: U Street from 14 to 18th Street, NW will be a total reconstruction including sidewalk, traffic signa	\$504,772	FY 2019
ED081A	PENNSYLVANIA AVE., SE PHASE II	This project will prepare and Environmental Assessment for FHWA & NPS for the Pennsylvania Ave SE and Minnesota Ave, SE intersection and the portion on Penn Ave between 27th street and the sousa bridge. 06/03/14 Section 106: Determination of Effects let	\$194,499	COMPLETED/CLOSEOUT
ED082A	EASTERN MARKET MANHOLE COVERS		\$58,750	COMPLETED/CLOSEOUT
ED083A	8888337 ARTWALK MET BRANCH & L&M TRAIL	Build the Metropolitan Branch Trail between L and M Streets NE.	\$551,818	COMPLETED/CLOSEOUT
ED084A	BICYCLE SERVICES GRANT	Furnish and install bicycle parking racks. also provide mobile bicycle repair workshop in underserved areas.	\$6,282	COMPLETED/CLOSEOUT
ED086A	Q STREET GREEN ALLEY BETWEEN Q PLACE AND Q ST. NW	To design and construct a permeable alley with stormwater planters.	\$43,744	FY 2017
ED088A	TIVOLI NORTH/MID 14TH STREET BUSINESS ASSOCIATION	Installation of tree fences in the 3900 Block of 14th st NW for the Tivoli North Businesses who were awarded the grant.	\$10,500	COMPLETED/CLOSEOUT
ED0C5A	VIRTUAL CIRCLE PEDESTRIAN ENHANCEMENTS	Traffic Safety Improvements for the Intersection of 1st St, Florida Ave, NY Ave and Eckington Place, NOMA Enhancement, Change Order #2	\$147,914	COMPLETED/CLOSEOUT
ED0C7A	STREETSCAPE IMPROVEMENTS IN MT. PLEASANT		\$302,500	COMPLETED/CLOSEOUT
ED0D2A	CONNECTICUT AVENUE MEDIAN STP-8888(377)	Historic DuPont Circle was awarded the grant to improve the median btw R st and S st along Conn Ave NW	\$15,375	COMPLETED/CLOSEOUT
ED0D3A	IMPERVIOUS PAVEMENT REMOVAL	Removal of impervious pavement to improve stormwater management and help DDOT to meet MS4 permit requirements. Project is complete.	\$111,402	COMPLETED/CLOSEOUT
ED0D5C	11TH STREET BRIDGE PARK	In partnership with a non-profit organization, DDOT is looking into using the old 11th street Bridge piers to support a new bridge superstructure, deck, land scape and other amenities.	\$4,450,000	FY 2020
ED0D6A	FY14 HERITAGE TRAIL SIGNAGE PROGRAM, PHASE II		\$42,688	COMPLETED/CLOSEOUT
ED0D7A	PLANTER SPACE CREATION		\$251,047	COMPLETED/CLOSEOUT
ED102C	RHODE ISLAND AVENUE NE SMALL AREA PLAN	Funding to plan and implement streetscape improvements along Rhode Island Avenue in keeping with the Great Streets Plan	\$2,609,353	FY 2018
ED302C	LOCAL STREETS PARKING STUDIES	Conduct parking studies to increase curbside parking supply and improve safety on local streets.	\$238,711	COMPLETED/CLOSEOUT
ED303C	LOCAL STREETS TRAFFIC STUDIES	Conduct transportation audits and transportation studies on local streets city-wide to improve safety and mobility. Studies would address multi-modal needs, including pedestrian systems, bicycle routes and lanes, transit services and automobiles.	\$275,974	COMPLETED/CLOSEOUT
ED305C	NEIGHBORHOOD STREETSCAPE IMPROVEMENTS	Implement streetscape improvements and livability study recommendations; including planning, design and construction of local roadways, sidewalks, alleys, streetlights, bicycle lanes, transit services, and street trees and treeboxes.	\$533,210	COMPLETED/CLOSEOUT
ED310C	CLEVELAND PARK STREETSCAPES	Safety improvements on the Connecticut Avenue corridor between Macomb Street and Porter Street. Improvements include new streetlights, updated crossing signal for pedestrians, mid-bloc crosswalk.	\$724,020	FY 2017
ED311C	KENNEDY STREETSCAPE		\$4,142,903	FY 2017
EDL01C	NEIGHBORHOOD STREETSCAPE		\$509,584	ONGOING
EDL03C	PENNSYLVANIA AVE, SE STREETSCAPE IMPROVEMENTS OLD TPPA PROJECT	Identify methods to improve transportation services, safety, and the visual appearance of the right-of-way to encourage or strengthen economic development and prepare concept design plans. Prepare environmental approval documents, detailed design plans a	\$168,044	FY 2016
EDL06C	MINNESOTA AVE. SE STREETSCAPE IMPROVEM'T	The construction of designed streetscape improvements.	\$20,220	COMPLETED/CLOSEOUT
EDL07C	HOWARD THEATER STREETSCAPE IMPROVEMENT	Reconstruction & Streetscape work on "T" St, Wiltberger St, Alley 1,2, & 3 and also development of Eliington Plaza.	\$4,541	COMPLETED/CLOSEOUT
EDL09C	GLOVER PARK STREETSCAPE	Prepare plans and specifications to make improvements to transportation services, pedestrian access, and the visual appearance, including lights and tree boxes, of commercial district of Glover Park	\$89,582	COMPLETED/CLOSEOUT
EDL17C	DUPONT CROWN PLAZA INFRASTRUCTURE	Capping of the underpass north of Dupont Circle	\$9,693,100	FY 2018
EDL19C	DOWNTOWN "WEST OF THE WHITE HOUSE" TRANSPORTATION PLANNING AND STREETSCAPE STUDY	The purpose of this planning study is to: - Engage the public; - Identify opportunities to improve the urban design, enhance the streetscape, and activate the public space along Pennsylvania Avenue NW between 17th Street NW and Washington Circle, includi	\$600,000	FY 2017
EDS00C	GREAT STREETS - GENERAL PLANNING	General Great Streets planning activities including, but not limited to, outreach, publications, advertising, small incubator projects, framework planning, engineering, etc.	\$85,729	FY 2018
EDS01C	GREAT STREETS-GEORGIA AVE/7TH STREET	Economic development improvements to 5 segment areas of Georgia Avenue/7th Street NW: Georgia Gateway, Brightwood, Petworth/Middle Georgia, Howard Town Center, and Shaw	\$126,722	COMPLETED/CLOSEOUT
EDS02C	H STREET BETWEEN 3RD AND 14TH STREET, NE	This project consist of reconstructing the roadway, sidewalks, install new lighting, upgraded utilities(WASA, GAS, PEPCO), new streetcar tracks with a catenary overhead.	\$547,722	COMPLETED/CLOSEOUT
EDS03C	GREAT STREETS-NANNIE HELEN BURROUGHS AVE NE	Streetlight, Traffic Signal, Streetscape, Safety Improvements and Low-Impact Development This project is completed	\$15	COMPLETED/CLOSEOUT
EDS04C	GREAT STREETS - MINNESOTA AVENUE NE/SE		\$85,241	COMPLETED/CLOSEOUT
EDS06C	STREETSCAPE AND SAFETY IMPROVEMENTS TO THREE SEGMENTS OF MARTIN LUTHER KING JR. AVENUE/SOUTH CAPITOL STREET CORRIDOR	Streetscape and safety improvements to three segments of Martin Luther King Jr. Avenue/South Capitol Street corridor: Anacostia (Good Hope Road to Howard Road), Congress Heights (Gate 4 to Esther Place), Bellevue extended (Esther Place to Southern Avenue	\$1,153,970	COMPLETED/CLOSEOUT
EQ901C	MAJOR EQUIPMENT ACQUISITION		\$460	COMPLETED/CLOSEOUT
EW001C	11TH ST BRIDGE		\$75,522	ONGOING

DC NUMBER	PROJECT TITLE	PROJECT DESCRIPTION	AVAILABLE FUNDS (1.29.2016)	Delivery Date
EW002C	E WASHINGTON STREET TRAFFIC RELIEF	The East Washington Project calls for building new ramps to and from the 11th Street Bridge on the east side of the Anacostia River to directly connect the Southeast Freeway and Kenilworth Avenue/DC-295. This will divert traffic from congested local street	\$3,486,909	FY 2016
FDT01A	RECONSTRUCTION OF THE SOUTHERN ENTRANCE OF THE GEORGETOWN UNIVERSITY IN THE DISTRICT OF COLUMBIA	This program is to design and construct Congressionally mandated demonstration projects required by the Surface Transportation and Uniform Relocation Assistance Act of 1987. (P.L. 100-17). This project was mandated by the U.S. Congress on behalf of Georg	\$59,375	COMPLETED/CLOSEOUT
FDT06A	GEOGRAPHIC INFORMATION SYSTEM - TRANSPORTATION ENTERPRISE ASSET MANAGEMENT SYSTEM	This program is to design and construct Congressionally mandated demonstration projects required by the Surface Transportation and Uniform Relocation Assistance Act 1987 (P.L. 100-17).	\$1,529,497	ONGOING
FDT09A	MOTOR VEHICLE INFO SYS MVIS-99-1(001)	This program is to design and construct Congressionally mandated demonstration projects required by the Surface Transportation and Uniform Relocation Assistance Act 1987 (P.L. 100-17).	\$58,090	COMPLETED/CLOSEOUT
FDT14A	STREETSCAPE IMPROVEMENTS M STREET SE SOUTH, NEW SIDEWALKS, CROSSWALKS PUBLIC SJ		\$1	COMPLETED/CLOSEOUT
FDT17A	BARRACKS ROW/MAIN STREET STREETSCAPE IMPROVEMENT PROJECT 8TH STREET, S.E., BETWEEN PENNSYLVANIA AVENUE, S.E. AND M STREET, S.E.	This program is to design and construct Congressionally mandated demonstration projects required by the Surface Transportation and Uniform Relocation Assistance Act 1987 (P.L. 100-17).	\$714,387	COMPLETED/CLOSEOUT
FDT22A	WATER COACH DEMONSTRATION	Water coach connecting waterfront locations in the District.	\$419,807	COMPLETED/CLOSEOUT
FDT25C	MBT RHODE ISLAND AVE BRIDGE	This bridge will connect the Metropolitan Branch Trail on the west side of the tracks with the WMATA Rhode Island Avenue Metro station on the east side of the tracks. This bridge will provide a much needed connection and eliminate an illegal railroad tra	\$1,373,149	COMPLETED/CLOSEOUT
FLD01C	PREVENTION OF FLOODING IN BLOOMINGDALE	This project is to install green infrastructure (GI) in the Bloomingdale and LeDroit Park neighborhoods as medium term flood mitigation per the Mayor's Task Force report. The report calls for DDOT spending \$10M over 5 years.	\$5,544,830	ONGOING
FM101C	FENWICK BULDN RENOVATION		-\$400	COMPLETED/CLOSEOUT
FRSTER	URBAN FORESTER PROGRAM	Mapping and planning planting sites throughout the city for trees on parks and schools properties.	\$80,140	FY 2017
GFL01C	DDOT FACILITIES	Faragut Site Development and Construction of the street and bridge facility as well as the truck shelter.	\$1,052,434	ONGOING
HTF02A	REHABILITATION OF 11TH ST SE BRIDGE OVER SOUTHEAST FRWY - GARVEE EXPENDITURES	The project consist of rehabilitation of existing deck, steel beams.	\$2,329,379	COMPLETED/CLOSEOUT
IRT05A	ROADWAY UPGRADING, RESURFACING & RESURFACING - DESIGN BUILD - WARDS 3 & 4 120 SITES - EASTERN FEDERAL LANDS HIGHWAYS DIVISION		\$567,670	COMPLETED/CLOSEOUT
IRT48A	FY99 3RD FA CITYWIDE ALLEY RESURFACING LOCAL STREETS BARNEY CIRCLE FUNDS	This project is in response to the Transportation Equity Act for the 21st Century (TEA-21), Public Law 105-178 and TEA-21 Restoration Act (Title IX of H.R. 2676). Under the law, the District is allowed to use \$97.8 million out of the full \$173 million fo	\$35,436	COMPLETED/CLOSEOUT
IRT59A	FY99 1ST FEDERAL AID DEAD TREE REMOVAL CONTRACT		\$221,400	COMPLETED/CLOSEOUT
IRT78A	DC NHS SYSTEM, ASSET PRESERVATION CONTRACT	This project is in response to the Transportation Equity Act for the 21st Century (TEA-21), Public Law 105-178 and TEA-21 Restoration Act (Title IX of H.R. 2676). Under the law, the District is allowed to use \$97.8 million out of the full \$173 million fo	\$6,399	COMPLETED/CLOSEOUT
MNT01A	CITYWIDE PUMP STATIONS REHAB		\$663,290	FY 2017
MNT02A	CULVERT REHABILITATION AND REPLACEMENT	2013 - The Purpose of this project is to replace the existing 6x9 culvert with a 20x9 culvert. 2014 - Inspect culvert citywide and develop a plan for replacemtn and / or rehab.	\$318,554	COMPLETED/CLOSEOUT
MNT03A	TREE ASSET MANAGEMENT	Asset Management for right of way vegetation and trees, to reduce safety issues related to dead, dying and diseased trees as well as treatment of plant health issues and vegetation management programs along the STP and NHS system. Contract awarded 12/17/	\$3,800,894	ONGOING
MNT04A	SHERIFF ROAD, NE SAFETY IMPROVEMENTS	This is a traffic calming and safety improvement project to address various issues along the corridor.	\$210,516	COMPLETED/CLOSEOUT
MNT05A	CITY WIDE ENGINEERING SERVICES FOR STRUCTURES AND BRIDGES	Citywide Open engineering services for structure and bridges.	\$6,079,277	FY 2016
MNT06A	CITYWIDE SIDEWALK AND RETAINING WALL CONDITION SURVEY	Citywide Sidewalk and Retaining Wall Condition Survey	\$5,469	COMPLETED/CLOSEOUT
MNT07A	MISSOURI AVENUE, KANSAS AVENUE, KENNEDY STREET INTERSECTION IMPROVEMENTS		\$824	COMPLETED/CLOSEOUT
MNT08A	FEDERAL AID PREVENTIVE MAINTENANCE AND EMERGENCY REPAIRS ON HIGHWAY STRUCTURES	A construction project to provide repair and preventive measures on bridges, culverts, walls and other highway structures.	\$9,803,732	ONGOING
MNT09A	FY13 TRAFFIC SIGNAL MAINTENANCE		\$11,434,205	ONGOING
MNT10A	FY13 FA PAVEMENT RESTORATION - NHS	Pavement Restoration on NHS routes, Milling, Paving, Sidewalk, curb & gutter upgrade	\$2,978,516	ONGOING
MNT11A	SHRP - PAVEMENT PRESERVATION ON HIGH VOLUME ROADS	DDOT has been selected as a lead adopter for SHRP2 under 'Pavement Preservation on High-Volume Roadways'. DDOT plans to perform pavement preservation on selected high-volume roadways by applying strategies and techniques found within SHRP2's guidelines an	\$109,561	ONGOING
MNT12A	ROADWAY CONDITION ASSESSMENT	The DDOT is the agency responsible for highway safety programs and highway preservation in the District. The agency annually collects roadway pavement condition information in order to: 1) monitor the health of the roadway network; 2) identify rehabilita	\$459,076	FY 2016
MNT13A	FY15 CW CONSULTANT BRIDGE INSPECTION		\$3,757,269	FY 2016
MNT14A	CW THERMOPLASTIC PAVEMENTS MARKINGS	To provide installation of new pavement markings and refurbishment on all STP and NHS routes throughout the District of Columbia.	\$255,533	FY 2016
MNT16A	15TH ST, NW INTERSECTION SAFETY IMPROVEMENTS		\$3,355,839	FY 2016
MNT19A	FY-15 FEDERAL AID PAVEMENT RESTORATION NHS ROUTES	National Highway System Routes Pavement Restoration project.	\$7,485,799	FY 2021
MNT28A	FY15 CITYWIDE OPEN END BRIDGE DESIGN CONSULTANT SERVICES		\$1,355,396	FY 2020
MRR01A	SAFETY AND GEOMETRIC IMPROVEMENTS OF I-295/DC 295	Safety and Geometric Improvements of I-295/DC 295 from Eastern Avenue to Chesapeake Street.	\$2,263,872	COMPLETED/CLOSEOUT
MRR03A	7TH STREET NW FROM N ST. TO FLORIDA AVE. (HOWARD THEATRE)	The 7th Street project limits were initially part of the Howard Theater Streetscape. However, to expedite the work around the theater, the 7th St limits were removed from the project at 100%.	\$8,163,859	COMPLETED/CLOSEOUT
MRR04A	REHABILITATION OF EAST CAPITOL STREET BRIDGE OVER ANACOSTIA RIVER (BRIDGE NO.233)	Rehabilitation of bridge including work to superstructure, substructure, lighting, railings, sign structures, pavement markings, etc.	\$1,417,653	FY 2016
MRR08A	LONG BRIDGE STUDY	The Long Bridge is a two track railroad bridge across the Potomac River used to carry freight and passenger rail (CSX, VRE, Amtrak). The bridge is owned by CSX. FRA gave DDOT a grant to study the bridge.	\$1,087,171	FY 2017
MRR09A	BLAIR / CEDAR / 4TH STREET NW	This S-legged, geometrically skewed intersection is complicated for vehicles and pedestrians. Because of its complex nature, the intersection operates at a LOS E-F and has a high crash rate. The intersection is located one block west of the Takoma Metro S	\$159,802	ONGOING
MRR11A	CANAL ROAD - PRELIMINARY STUDY		\$267,996	FY 2016
MRR12A	BOUNDARY STONES PRESERVATION PROJECT	Locate boundary stones in the District of Columbia. Assess conditions and restore as appropriate.	\$60,547	COMPLETED/CLOSEOUT
MRR14A	REHABILITATION OF ANACOSTIA FREEWAY BRIDGES OVER SOUTH CAPITOL STREET (BRIDGES NO. 1016 & 1017)	A two span simply supported steel multi-beam structure with a concrete deck and a latex modified concrete wearing surface. The superstructure is supported on reinforced concrete cantilever abutments and a reinforced concrete pier with a concrete cap suppo	\$1,774,875	FY 2019
MRR15A	ANACOSTIA FREEWAY BRIDGES OVER NICHOLSON STREET, S.E. (BRIDGES NO. 1001, 1001(RAMP 6), 1002(RAMP 4))	Rehabilitation of Anacostia Freeway Bridges over Nicholson Street, S.E. (Bridges No. 1001, 1001(Ramp 6), 1002(Ramp 4))	\$1,411,616	FY 2017
MRR16C	VIRGINIA AVENUE TUNNEL	The District of Columbia Department of Transportation (DDOT) and the Federal Highway Administration (FHWA) will be preparing an Environmental Impact Statement (EIS) for the re-construction of the Virginia Avenue Tunnel (VAT). CSX Transportation, Inc. (CSX	\$1,776,884	FY 2019
MRR19A	CONNECTICUT AVENUE STREETSCAPE, PHASE 3	This job number is for construction of Phase III only. NTP 2/1/14. Former Design Contract was DC #SR078A.	\$1,474,857	COMPLETED/CLOSEOUT
MRR20A	WARDS 5 & 6 RESURFACING AND UPGRADES		\$725,357	COMPLETED/CLOSEOUT

DC NUMBER	PROJECT TITLE	PROJECT DESCRIPTION	AVAILABLE FUNDS (1.29.2016)	Delivery Date
MRR21A	REHAB OF 6 BRIDGES OVER WATTS BRANCH	Work includes but not limited to the following: New superstructure for Bridge Nos. 0129,0132, 0204 and 0222. New wearing Surface for Bridge Nos.0196 and 0199. NEW deck joints for all the six bridges. Replacement of blackwalls for deck extension/approach s	\$1,450,211	COMPLETED/CLOSEOUT
MRR22A	MINNESOTA AVE. REVITALIZATION, PHASE 1, FROM A ST. TO 300 FEET S. BENNING RD., NE	The work under this contract includes the reconstruction of Minnesota Avenue from A Street, SE to 300 feet south of Benning Road, NE. The project corridor is approximately one-half mile in length, includes the East Capitol Street Bridge (Minnesota Aven	\$14,578,312	FY 2017
MRR23A	REHAB OF 1ST ST NE FROM G ST TO MASSACHUSETTS AVE		\$540,760	FY 2018
MRR26A	MONROE STREET, NE BRIDGE OVER CSX \$ WMATA	The bridge structure carries Monroe Street NE over Washington Metropolitan Area Transit Authority (WMATA) and CSX tracks	\$1,475,734	FY 2018
MRR27A	REHABILITATION OF I-395 HOV BRIDGE OVER POTOMAC RIVER	Repair extensive pier cracking, superstructure and substructure rehabilitation.	\$731,887	FY 2018
MRR31A	REVITALIZATION OF MINNESOTA AVE, NE, PHASE II 300FT SOUTH OF BENNING RD TO SHERIFF RD	Reconstruction and safety improvements of Minnesota Avenue NE from 300 feet south of Benning Road to Sheriff Road	\$373,694	FY 2018
MRR32A	14TH STREET, SW BRIDGES (BRIDGES NO. 0171-1,2, AND 3, 021, 1134, AND 1134A-1)	Rehabilitation of the bridge sub/superstructures and approach roadway improvements.	\$1,625,065	FY 2018
MRR33A	REHABILITATION OF KEY BRIDGE		\$26,757,658	FY 2018
MRR34A	GA AVE BUS IMPROVEMENTS		\$1,883,600	FY 2016
MRR35A	KLINGLE VALLEY TRAIL		\$4,841,935	FY 2016
MRR36A	27TH STREET BRIDGE OVER BROAD BRANCH, NW	Reconstruction of 27th Street Bridge over Broad Branch NW	\$1,092,525	COMPLETED/CLOSEOUT
MRR42A	BLAIR RD / CEDAR ST / 4TH ST, NW	This 5-legged, geometrically skewed intersection is complicated for vehicles and pedestrians. Because of its complex nature, the intersection operates at a LOS E-F and has a high crash rate. The intersection is located one block west of the Takoma Metro	\$2,710,597	FY 2017
MRR43A	FY15 BRIDGE MANAGEMENT PROGRAM		\$363,400	FY 2016
MRR47A	PENNSYLVANIA AVE. NW BRIDGE OVER ROCK CREEK (BRIDGE NO. 0118)	Investigation and design for rehabilitation of the bridge superstructure and approach roadway improvements.	\$8,073,426	FY 2018
MRR50A	SAFETY IMPROVEMENT NEW JERSEY AVE FROM H STREET TO N STREET, NW, RECONSTRUCTION OF NEW YORK AVE. N.W. FRO FRIST TO 3RD ST.	THIS is a safety improvement project to facilitate pedestrian and motorists flows. New Jersey will be converted into two traffic from New York to K Street, NW. And, Reconstruction of New York Ave N.W from First to 3rd Street	\$13,310,794	FY 2018
MRR53A	KENILWORTH AVENUE NE (NORTH BOUND), FROM EAST CAPITOL STREET RAMP TO CSX RAIL ROAD OVER PASS SOUTH OF NANNIE HLEN BURROUGHS AVE)	Reconstruction of the Kenilworth Avenue NE, North bound, from East Capitol Street Ramp to CSX Rail Road Bridge overpass South of Nannie Hellen Burroughs Avenue	\$6,284,600	FY 2018
MRR58A	REHABILITATION OF 16TH ST BRIDGE OVER PINEY BRANCH RD, NW. (BRIDGE NO. 0022)	Rehabilitation of 16th Street Bridge over Piney Branch Parkway, NW, Bridge No. 0022, to include deck repair, utility replacement to preserve the integrity and extend the life of the masonry and reinforced concrete arch superstructure. Completion of the int	\$875,371	FY 2017
MRR59A	REHABILITATION OF EASTERN AVENUE FROM NEW HAMPSHIRE AVE, NE TO WHITTER ST, NW	Rehabilitate or Reconstruct Asphalt Overlay on Concrete Pavement, replace deteriorated catch basins, manholes, curb and ramps	\$577,843	FY 2017
MRR62A	MARYLAND AVENUE NE MULTI-MODAL SAFETY AND ACCESS PROJECT	Maryland Avenue Corridor Multi-modal Safety and Access Project, from 2nd Street NE to 15th Street NE, including the streets along the perimeter of Stanton Park (C Street, 4th Street, and 6th Street).	\$618,230	FY 2017
MRR63A	RECONSTRUCTION OF SB KENILWORTH AVE .	Reconstruction of the Southbound Kenilworth Avenue NE, is from East Capitol Street Ramp to CSX Rail Road Bridge overpass South of Nannie Helen Burroughs Avenue	\$1,064,996	FY 2017
NPP01C	NEIGHBORHOOD PARKING PERFORMANCE FUND	Funds for neighborhood transportation improvements in Performance Parking Zones.	\$3,310,495	ONGOING
OSS01A	K STREET NW ADA IMPROVEMENTS	Address ADA deficiencies along the K Street NW from 12th Street to 21st Street.	\$1,016,467	ONGOING
OSS06A	INFRASTRUCTURE INFORMATION TECHNOLOGY SUPPORT SERVICES	On Going IT support Services for programmers, DBA and Business Analyst	\$549,652	FY 2017
OSS07A	CONSTRUCTABILITY AND WORK ZONE SAFETY		\$418,093	FY 2016
OSS09A	WEIGH-IN-MOTION		\$950,000	ONGOING
OSS11A	TRUCK SIZE AND WEIGHT		\$134,114	FY 2017
OSS12A	MOVEABLE BARRIER SYSTEM		\$527,540	ONGOING
OSS13A	CONSTRUCTION OF DDOT ADAPTIVE SIGNAL CONTROL SYSTEM	Implementation of Adaptive Signal System on New York Ave, Rhode Island Ave and Pennsylvania Avenue Corridors.	\$1,198,557	FY 2016
OSS31A	THOMAS CIRCLE TUNNEL LIGHTS CONVERSION TO LED LIGHTS	The objective of this project is to upgrade the existing condition of the tunnel lights and controller under the Thomas Circle Tunnel. The project includes replacing the existing lights with new LED lights, installing the new conduit system, and cables. T	\$203,919	ONGOING
OSS33A	MOUNT PLEASANT STREET LIGHTING UPGRADE	Lighting Upgrade with complete system including manhole, conduit LED lights and Historic Washington Globe Pole/Fixture	\$284,977	FY 2016
OSS36A	STREETLIGHT UPGRADE ON MASSACHUSETTS AVE FROM 19TH ST SE TO 6TH ST NE	The objective of this project is to upgrade the existing condition of the streetlights on this corridor. The project includes replacing the existing lights with new LED lights, installing new conduit system, manholes, and cables. OCP is currently processi	\$2,917,247	FY 2017
OSS37A	SECURITY AUDIT FOR TRAFFIC SIGNALS AND ITS COMMUNICATION	The project aim to make an inventory of the currebt traffic and networking infrastructure in DDOT taking into account the proposed upgrades to the system. Additionally this project will measure the impact of remote attackers into the system and recommend	\$146,000	FY 2017
OSS38A	CW STREETLIGHT ASSET MANAGEMENT SERVICES	Streetlight Asset contract- 2nd Generation Revised .This 3-year lighting contract to maintain and rehabilitate the District's aging electrical system.	\$7,389,376	FY 2019
OSS39A	TAP – KEY BRIDGE LIGHTING	The Key Bridge is an eight span reinforced concrete open spandrel arch structure that carries six lanes of two-way traffic between Northern Virginia and the District of Columbia over the C&O Canal, the Whitehurst Freeway and K Street, the Potomac River, a	\$350,000	FY 2016
OSS40A	DIESEL IDLE REDUCTION PROGRAM	The Diesel Idle Reduction Program identifies and implement projects that reduce Particulate Matter (PM) 2.5 emissions in the District of Columbia	\$1,200,000	FY 2016
OSS42A	UTILITY LOCATION 3D DATA REPOSITORY		\$340,000	FY 2017
PED5BR	PARKSIDE PEDESTRIAN BRIDGE	Project is collaborative effort with DMPED and Parkside Developer. 25% of funding, up to \$2.5 Mil to provided by developer and \$6 Mil to be provided by DMPED from DOT PILOT funds.	\$900,016	FY 2019
PLU00C	POWER LINE UNDERGROUNDING		\$12,442,267	ONGOING
PM025A	GIS-WEB BASED UTILITY NOTIFICATION	The Department is requesting \$650,000 in new funding to develop a web based GIS application to notify utility companies on permitting. The purpose of this project is to 1) facilitate the two-year plan reports that utility and telecommunication companies	\$30,835	COMPLETED/CLOSEOUT
PM043A	FY06 TECHNOLOGY TRANSFER AND QUICK RESPONSE	Requests for pressing research needs often arise between annual research project solicitations.	\$218	COMPLETED/CLOSEOUT
PM062A	FY10 RESEARCH AND TECHNOLOGY	The purpose of the Research Program is to support the broad mission of the agency, which is to enhance the quality of life for District residents and visitors by ensuring that people, goods, and information move efficiently and safely, with minimal advers	\$321,943	COMPLETED/CLOSEOUT
PM067A	RIGHTS OF WAY PROGRAM - FEDERAL	Assemble and document data on DDOT-controlled lands in the District of Columbia and develop a geo-based land data map. Provide annual funding for surveys, title searches, appraisals and other land acquisition and disposal activities prior to the developme	\$45,133	COMPLETED/CLOSEOUT
PM080A	DDOT TRANSPORTATION PLANNING MANUAL	This project will define DDOT planning procedures.	\$197,591	FY 2016
PM081A	LP_FAR NORTHEAST LIVABILITY PLAN (49TH STREET)	Develop design plans for the implementation of traffic calming measure recommended in the Far Northeast Livability study and make all handicap ramps ADA compliant.	\$37,778	COMPLETED/CLOSEOUT
PM086A	TRAVEL AND TRAINING	The Departments ability to maintain the Districts transportation infrastructure and services is adversely impacted by its non-competitive salary structure and the declining supply of skilled employees. The Department is challenged to meet the increase in	\$91,286	COMPLETED/CLOSEOUT
PM087A	RESEARCH AND TECHNOLOGY	The purpose of the Research Program is to support the broad mission of the agency, which is to enhance the quality of life for District residents and visitors by ensuring that people, goods, and information move efficiently and safely, with minimal advers	\$702,120	ONGOING

DC NUMBER	PROJECT TITLE	PROJECT DESCRIPTION	AVAILABLE FUNDS (1.29.2016)	Delivery Date
PM088A	CW TRANSPORTATION MANAGEMENT PLAN	Prepare a citywide transportation management plan to respond to stakeholders concerns regarding the traffic impacts due to multiple construction projects.	\$208,967	FY 2016
PM089A	GREEN STREETS - FY11 TE		\$1,569,708	FY 2016
PM091A	LID STANDARDS	Creation of citywide design standards, drawings, and specifications for Low Impact Design and Green Infrastructure practices.	\$2,043	COMPLETED/CLOSEOUT
PM094A	AASHTOWARE PAYMENT	AASHTOWARE Trans*port Annula Licenses. This Balance will roll over to FY14 Annual license fees	\$8,500	COMPLETED/CLOSEOUT
PM096A	FY 11 DBE SUPPORTIVE SERVICES	The Transportation Equity Act of the 21st Century (TEA-21) under section 1208 reauthorized the appropriation of Disadvantaged Business Enterprise/Supportive Services (DBE/SS) funds for distribution to all states and the District of Columbia to implement t	\$12,491	COMPLETED/CLOSEOUT
PM097A	MATOC	Interjurisdictional coordination and information sharing for regional traffic incidents that have an impact outside jurisdictional boundaries.	\$500,003	ONGOING
PM098A	SPR	The State Planning and Research Program (SP&R) is a program of salaries and services funded from 2 percent of funds apportioned for selected federal highway-aid categories. The SP&R Program is mandated pursuant to 23 U.S.C. 103(i)(6), 133(b)(7), 157(C) an	\$174,903	COMPLETED/CLOSEOUT
PM0A2A	DISTRICT STIP DEVELOPMENT		\$49,474	COMPLETED/CLOSEOUT
PM0A4A	MANAGED LANES STUDY	The project is to perform a high level feasibility review to identify any potential flaws or major obstacles to completing the project as a public-private partnership (P3) and lay out the critical path to moving the project forward.	\$278,707	COMPLETED/CLOSEOUT
PM0A9A	DAVIS BACON - AUDIT AND COMPLIANCE	The Davis Bacon Compliance Project oversees audit and compliance for all construction projects greater than two thousand dollars and enforces the prevailing wage requirements of the Davis-Bacon and Related Acts (DBRA) and other statutes applicable to Fede	\$819,174	ONGOING
PM0B1A	ASSET INVENTORY & ADA COMPLIANCE	Project 1) Asset Inventory & ADA Compliance citywide.	\$768,036	ONGOING
PM0B2A	FY14 METROPOLITAN PLANNING	Project 2) Development of a Comprehensive ADA/Section 504 Transition Plan	\$665,824	ONGOING
PM0B3A	FY14 STATE PLANNING AND RESEARCH PROGRAM		\$1,246,478	COMPLETED/CLOSEOUT
PM0B4A	FY14 RESEARCH AND TECHNOLOGY	The Research and Technology Transfer Program coordinates the agency's research activities, helping to deliver life cycle cost savings and innovative solutions that improve the quality of life in the District. Guided by the Research Strategic Plan, which I	\$323,434	COMPLETED/CLOSEOUT
PM0B6A	FY14 TRAINING EDUCATION AND DEVELOPMENT		\$54	COMPLETED/CLOSEOUT
PM0B7A	FY13 ON THE JOB SUPPORTIVE SERVICES		\$20,248	COMPLETED/CLOSEOUT
PM0B8A	CIVIL RIGHTS EEO COMPLIANCE MONITORING		\$237,547	ONGOING
PM0C1A	FY15 EDUCATION, TRAINING AND DEVELOPMENT	The Department's ability to maintain the District's transportation infrastructure and services is adversely impacted by its non-competitive salary structure and the declining supply of skilled employees. The Department is challenged to meet the increase i	\$20,712	COMPLETED/CLOSEOUT
PM0C2A	FY15 STATE PLANNING AND RESEARCH PROGRAM SPR		\$625,620	FY 2016
PM0C3A	FY15 RESEARCH AND TECHNOLOGY		\$665,070	ONGOING
PM0C4A	FY 2015 COMMUTER CONNECTIONS		\$225,364	COMPLETED/CLOSEOUT
PM0C5A	FY 2015 METROPOLITAN PLANNING		\$746,718	COMPLETED/CLOSEOUT
PM0C6A	FY15 ON THE JOB TRAINING		\$34,876	COMPLETED/CLOSEOUT
PM0C7A	FY15 CIVIL RIGHTS	Civil Rights programs and monitoring	\$444,816	ONGOING
PM0C8A	FY15 DBE SUPPORTIVE SERVICES		\$53,814	COMPLETED/CLOSEOUT
PM0C9A	TRANSPORTATION ALTERNATIVES - GREEN ALLEYS	Design Green Alleys.	\$252,282	ONGOING
PM0D1A	FY13 DBE SUPPORTIVE SERVICES		\$27	COMPLETED/CLOSEOUT
PM0D3A	FY14 ENVIRONMENTAL MANAGEMENT SYSTEM (EMS)	This project implements DDOT's environmental oversight.	\$511,388	ONGOING
PM0D8A	EMERGENCY COMMUNICATION SYSTEM IN THE MALL TUNNEL		\$6,396,189	FY 2017
PM0D9A	RESEARCH & INNOVATION IMPLEMENTATION AND EVALUATION	This project is aimed to help the Research Program identify relevant best practices from various sources (such as national research, other agencies, industry, DDOT research) and implement them across different program in DDOT. The funding will also help e	\$495,920	ONGOING
PM0E6A	MANAGED LANE CORRIDOR ANALYSIS STUDY	Managed Lanes Corridor Analysis	\$2,492,435	FY 2016
PM0E8A	DISTRICT STATEWIDE FREIGHT SIGNAGE PLAN	Development of a District freight plan to enhance the safety and efficiency of goods movement	\$173,290	FY 2019
PM0E9A	49TH ST, NE TRAFFIC CALMING PROJECT	Construction of traffic calming improvements along 49th Street, N.E from E. Capitol Street to Minnesota Ave. It includes implementing low impact traffic calming devices and upgrading handicap ramps to be ADA compliant. Low impact traffic calming devices s	\$563,574	COMPLETED/CLOSEOUT
PM0F1A	FY16 EDUCATION, TRAINING AND DEVELOPMENT	The Department's ability to maintain the District's transportation infrastructure and services is adversely impacted by its non-competitive salary structure and the declining supply of skilled employees. The Department is challenged to meet the increase i	\$11,891	FY 2016
PM0F4A	COMMUTER CONNECTIONS		\$656,570	FY 2017
PM0F5A	METROPOLITAN PLANNING	Metropolitan Planning Funds or PL funds are used to support activities undertaken by metropolitan planning organizations. In the case of the District, the Metropolitan Washington Council of Governments is the recipient of a mandatory set-aside from certai	\$1,743,936	FY 2017
PM0G5A	ASSET INVENTORY & ADA COMPLIANCE 2015	Asset Inventory & ADA Compliance citywide 2015	\$1,553,476	FY 2016
PM0G6A	16TH STREET TRANSIT PRIORITY PLANNING STUDY	PPSA is undertaking a planning study of 16th Street NW between H Street and Arkansas Avenue to improve transit performance and reliability. The 16th Street line currently serves over 20,000 riders each weekday, but suffers from slow travel speeds, pass-by	\$485,507	FY 2016
PM0G8A	CLEVELAND PARK STREETScape AND DRAINAGE IMPROVEMENT		\$531,887	FY 2017
PM0H4A	SUMMER TRANSPORTATION INSTITUTE		\$12,590	COMPLETED/CLOSEOUT
PM0H5A	EAST CAPITOL STREET CORRIDOR MOBILITY & SAFETY PLAN		\$516,442	FY 2018
PM0H6A	LEGAL COMPLIANCE REVIEW OF THE SOUTH CAPITAL STREET PROJECTS		\$309,874	FY 2017
PM0H7A	CONCRETE TESTING EQUIPMENT		\$5,000	COMPLETED/CLOSEOUT
PM0H8A	FY16 SPR PROGRAM		\$559,989	FY 2016
PM0H9A	DBE SUPPORTIVE SERVICES	The District Department of Transportation (DDOT) commits to administering a (flexible) two-year BDP designed to improve the success, opportunities and utilization of DBEs on federally-assisted construction and consultant contracts. DDOT will target/identify/enroll 15 underutilized DBEs with potential for success as the first priority for BDP participation.	\$53,699	FY 2016
PM0J1A	ON THE JOB TRAINING	The District of Columbia Department of Transportation (DDOT) is requesting \$41,508 from the Federal Highway Administration (FHWA) for Fiscal Year 2015 to partner with a qualified vendor to develop a four (4) -six (6) week program to implement the Readiness Engagement for Applied Careers in the Heavy Highway Industry (REACH-HI) program. The purpose of the program is to implement a training program that targets men and women between the ages of 18-24 who are transitioning out of the foster care system and other out of school youth and thereby need to be engaged in a training activity that will lead to economic sustainability.	\$41,508	FY 2016
PM0J2A	AASHTOWARE PAYMENT	AASHTOWARE Trans*port Annual Licenses.	\$304,850	ONGOING
PM0MLC	MATERIALS TESTING LAB		\$2,000,000	FY 2018
PM0MTC	MATERIAL TESTING	QA/QC Citywide program	\$1,467,577	ONGOING
PM301C	IN HOUSE PLANNING PROJECTS	This project funds in-house projects and personnel costs related to neighborhood planning, policy analysis, research, proposal development, and development review / traffic impact studies.	\$49,621	FY 2017

DC NUMBER	PROJECT TITLE	PROJECT DESCRIPTION	AVAILABLE FUNDS (1.29.2016)	Delivery Date
PM302C	PARKING PROJECTS:PLAN & IMPLEMENTATION	Provide DDOT with a blueprint for strategic planning that supports the creation of public parking facilities throughout the District	\$280,493	COMPLETED/CLOSEOUT
PM303C	PLANNING PROJECTS PLANNING & PRELIMINARY D	This project funds planning studies and other projects that DDOT contracts out to meet agency and city goals. It includes Livability Studies, neighborhoods plans, environmental initiatives, public engagement activities, freight planning, report productio	\$445,872	COMPLETED/CLOSEOUT
PM304C	ADVANCED DESIGN AND PROJECT CONSTRUCTION	This project funds charge codes for DDOT staff in IPMA/TOA, etc to be able to charge for their time in reviewing/participating in PPSA Studies and Plans.	\$1,006,913	FY 2017
PMT02A	GIS/CAD DATA CONVERSION SPRPRPL-2(33)	The purpose of the project is to continue the development of the District of Columbia Geographic Information System. The purpose of the system is to provide computer tools and a common graphical, digital set of information to assist the department in ser	\$327,500	COMPLETED/CLOSEOUT
PMT04C	GIS-100% LOCALLY FUNDED	The purpose of this project is to continue the development of the District of Columbia's Geographical Information System. This project of the GIS is to fund elements not eligible for Federal participation. The total cost of this project will be 14 milli	\$2,433	COMPLETED/CLOSEOUT
PMT10A	POLICY, PROCEDURE AND GUIDELINE FOR BRIDGE, DEVELOPMENT OF POLICY PROCEDURE MANUAL	Project to develop and update policy and procedure manuals for DDOT	\$141,435	COMPLETED/CLOSEOUT
PMT28A	GIS PROGR IMPLEMENTATION GIS-1999(002)	The purpose of this project is to continue efforts to complete a Geographic Information System (GIS) for the District of Columbia. A total of \$7.5 million (matched by an additional \$1,875,000 in District Highway Trust Funds) from the Transportation Equit	-\$73,740	FY 2016
PMT40A	RIGHT OF WAY MANAGEMENT PROGRAM CONSULTANT	Develop right of way (ROW)policies and procedures intended to establish a fair and efficient manner to completeproperty acquisitions or transfers, consistent with federal and local regulations.	\$182,919	COMPLETED/CLOSEOUT
RIVERS	RIVERSMART WASHINGTON	Install Low Impact Development (LID) in two sewersheds to maximize stormwater control and volume reduction. LID practices to be installed include green alleys, permeable pavement in parking lanes and roads, and bioretention areas in the tree space and bu	\$353,153	COMPLETED/CLOSEOUT
SA306C	STREETCARS	This project supports the design, construction, operations planning, start-up, and program management of the DC Streetcar program. There are two streetcar projects in design-construction:(1) The Anacostia Initial Line Segment connects the Anacostia Me	\$55,572,480	ONGOING
SR004A	REHABILITATION OF NEW HAMPSHIRE AVE. NW, DUPONT CIRCLE TO VIRGINIA AVE.	Roadway Resurfacing, reconstruction, and improvement of New Hampshire Ave, bet Dupont Cir. & Virginia Ave.	\$1,275,571	COMPLETED/CLOSEOUT
SR008A	WARD 3 RESURFACING, RECONSTRUCTION, UPGRADING DESIGN ON STP ROUTES	Roadway Resurfacing, Roadway Reconstruction, and Roadway Upgrading will be combined into this new project. Each contract will be developed by ward to perform resurfacing, reconstruction and upgrading within the same geographic area. It is believed that	\$11,867	COMPLETED/CLOSEOUT
SR009A	RECONSTRUCTION OF OREGON AVE NW FROM MILITARY RD TO WESTERN AVE	Design and prepare construction documents for roadway improvement, installation of new sidewalk on west side, new curb and gutter, streetlights, signage and pavement markings, drainage structures and system, LID facilities and a new bridge over Pinehurst	\$1,076,443	ONGOING
SR010A	WARD 4 RESURFACING/RECONSTRUCTION/UPGRADING DESIGN ON STP ROUTES	Roadway Resurfacing, Roadway Reconstruction, and Roadway Upgrading will be combined into this new project. Each contract will be developed by ward to perform resurfacing, reconstruction and upgrading within the same geographic area. It is believed that	\$138,279	COMPLETED/CLOSEOUT
SR014A	FY06 CITYWIDE F.A. PAVEMENT RESTORATION	Roadway Resurfacing, Roadway Reconstruction, and Roadway Upgrading will be combined into this new project. Each contract will be developed by ward to perform resurfacing, reconstruction and upgrading within the same geographic area. It is believed that	\$1,479,345	COMPLETED/CLOSEOUT
SR018A	WARD 5 & 6 FA PAVEMENT RESTORATION/RESURFACING STP ROUTES	Roadway Resurfacing, Roadway Reconstruction, and Roadway Upgrading will be combined into this new project. Each contract will be developed by ward to perform resurfacing, reconstruction and upgrading within the same geographic area. It is believed that	\$8,337	COMPLETED/CLOSEOUT
SR022A	CITYWIDE PAVEMENT RESTORATION ON STP & NHS ROUTES	Roadway Resurfacing, Roadway Reconstruction, and Roadway Upgrading will be combined into this new project. Each contract will be developed by ward to perform resurfacing, reconstruction and upgrading within the same geographic area. It is believed that	\$129,240	COMPLETED/CLOSEOUT
SR026A	FY05 PRELIMINARY PROJECT DEVELOPMENT CITYWIDE	Roadway Resurfacing, Roadway Reconstruction, and Roadway Upgrading will be combined into this new project. Each contract will be developed by ward to perform resurfacing, reconstruction and upgrading within the same geographic area. It is believed that	\$15,147	COMPLETED/CLOSEOUT
SR032A	INTERESECTON IMPROVEMENTS AT SOUTH DAKOTA AVE AND RIGGS RD	Roadway Resurfacing, Roadway Reconstruction, and Roadway Upgrading will be combined into this new project. Each contract will be developed by ward to perform resurfacing, reconstruction and upgrading within the same geographic area. It is believed that	\$647,604	COMPLETED/CLOSEOUT
SR033A	EASTERN AVENUE, RANDOLPH RD. TO MICHIGAN AVE, EASTERN AVE FROM SARGENT TO CUL-DE-SAC	Roadway Resurfacing, Roadway Reconstruction, and Roadway Upgrading will be combined into this new project. Each contract will be developed by ward to perform resurfacing, reconstruction and upgrading within the same geographic area. It is believed that	\$851,871	COMPLETED/CLOSEOUT
SR035A	ENVIRONMENTAL ASSESSMENT OF OREGON AVE NW FROM MILITARY RD AND WESTERN AVE	Environmental Assessment of Oregon Avenue.	\$388,704	COMPLETED/CLOSEOUT
SR036A	RECONSTRUCTION OF 18TH ST, NW FLORIDA AVE TO COLUMBIA RD	Total reconstruction of 18th Street including alignment change. Sidewalk will be widened by 6' and 4' on each side and angle parking will be converted to parallel parking.	\$2,743,510	COMPLETED/CLOSEOUT
SR037A	FY 2007 FEDERAL AID PAVEMENT RESTORATION NHS ROUTES.	National Highway System Routes Pavement Restoration project. FY13 projects.	\$1,285,852	ONGOING
SR046A	COLUMBIA HEIGHTS/PARK ROAD	See CKTA6A and ED026AREconstruction of Park Road from 14th St. to Mt. Pleasant and Reconstruction of 14th from Columbia Rd to Newton St.	\$300,072	COMPLETED/CLOSEOUT
SR049A	KENILWORTH AVENUE NE (NORTH BOUND), FROM EAST CAPITOL STREET RAMP TO CSX RAIL ROAD OVER PASS SOUTH OF NANNIE HLEN BURROUGHS AVE)	Reconstruction of the Kenilworth Avenue NE, North bound, from East Capitol Street Ramp to CSX Rail Road Bridge overpass South of Nannie Hellen Burroughs Avenue	\$202,996	COMPLETED/CLOSEOUT
SR052A	AMERICAN VETERANS DISABLED FOR LIFE MEMORIAL	Phase I: Installation of a new telecommunications ductbankPhase II: Closing of C Street between Washington Avenue SW and 2nd Street	\$1,220,131	COMPLETED/CLOSEOUT
SR055A	SAFETY IMPROVEMENT NEW JERSEY AVE FROM H STREET TO N STREET, NW, RECONSTRUCTION OF NEW YORK AVE. N.W. FRO FRIST TO 3RD ST.	THIS is a safety improvement project to facilitate pedestrian and motorists flows. New Jersey will be converted into two traffic from New York to K Street, NW. And, Reconstruction of New York Ave N.W from First to 3rd Street	\$228,011	COMPLETED/CLOSEOUT
SR057A	RECONSTRUCTION OF FLORIDA AVENUE NW. FROM 9TH/U ST. TO SHERMAN AVE./BERRY ST.	Total roadway reconstruction, upgrading catch basin, street lights, traffic signals, widening sidewalk (ADA compliance), new signals @ 9th & V St, Planting new trees,lane marking, LID and comply with new GIS manual.Contract SOW is expanded to include new	\$1,089,964	FY 2018
SR059A	SHERMAN AVENUE	Reconstruction of roadway, upgrading catch basin, street lights, traffic signals, widening sidewalk, planting new trees and lane marking.	\$2,002,261	COMPLETED/CLOSEOUT
SR060A	ENVIRONMENTAL ASSESSMENT OF BROAD BRANCH ROAD NW FROM LINNEAN AVE TO BEACH DRIVE	Environmental Assessment of Broad Broanch Road from Linnean Avne to Beach Drive.	\$116,664	COMPLETED/CLOSEOUT
SR061A	RESURFACING OF 4TH ST, NW		\$5,098	COMPLETED/CLOSEOUT
SR065A	KLINGLE VALLEY TRAIL	The Federal Highway Administration (FHWA), in conjunction with the District Department of Transportation (DDOT) and in cooperation with the National Park Service (NPS), proposed the construction of a multi-use trail facility within the 0.7 mile barricaded	\$68,657	COMPLETED/CLOSEOUT
SR068A	WESTERN AVE, NW - ARRA		\$7,180	COMPLETED/CLOSEOUT
SR070A	14TH ST. NW STREETScape, FROM THOMAS CIRCLE TO FLORIDA AVENUE	This project is an implementation of 14th Street NW from Thomas Circle to Florida Ave Study recommendations. The scope of work will include, but will not be limited to, the preparation of plans, estimate, and specifications for roadway resurfacing	\$146,659	FY 2017
SR071A	CAPITOL HILL INFRASTRUCTURE IMPROVEMENTS, 17TH STREET BENNING RD TO POTOMAC AVE	Review of Capitol Hill Study recommendation to address today's safety and transportation issues along this corridor.	\$86,146	FY 2017
SR072A	RESURFACING OF 17TH ST NW	Provide transportation, pedestrian and bicycle safety improvements, as well as streetscape enhancements to the 17th Street NW corridor between Massachusetts Avenue and New Hampshire Avenue	\$315	COMPLETED/CLOSEOUT

Question 17

**KA0 FEDERAL OPERATING GRANTS
FY2015 PRE CAFR**

Grant No	Grant Title	GAAP Category	Budget	Expense/Obligation	Variance
NHTSA1	NAT HIGHWAY TRANSPORT SAFETY ADMIN FY00	NPS	4,414,244	4,414,244	(0)
NHTSA1 Total			4,414,244	4,414,244	(0)
PLANNG	METROPOLITAN PLANNING	NPS	381,953	381,951	2
PLANNG Total			381,953	381,951	2
TRANSP	TRANSP. FOR ELDERLY AND DISABLED	NPS	272,770	272,769	1
TRANSP Total		NPS	272,770	272,769	1
UTREE1	URBAN & COMMUNITY FORESTRY PRG	NPS	92,627	92,577	50
UTREE1 Total			92,627	92,577	50
UTREE8	WATERSHED FORESTRY FUND PRG	NPS	36,000	36,000	-
UTREE8 Total			36,000	36,000	-
Grand Total			5,197,594	5,197,542	52
Footnote: Variance due to A/P posting a credit, creating a false budget.					
Data Source: CFO Solve					
FY15, Month 13, AY15, Appr Fund 0200, Agy Fund 8200					

**KA0 FEDERAL OPERATING GRANTS
FY2016 - DECEMBER 2015**

Grant No	Grant Title	GAAP Category	Budget	Expense/Obligation	Available Balance
NHTSA1	NAT HIGHWAY TRANSPORT SAFETY ADMIN FY00	02	7,335,000	539,409	6,795,591
NHTSA1 Total			7,335,000	539,409	6,795,591
PLANNG	METROPOLITAN PLANNING	02	100,000	-	100,000
PLANNG Total			100,000	-	100,000
TRANSP	TRANSP. FOR ELDERLY AND DISABLED	02	150,000	-	150,000
TRANSP Total			150,000	-	150,000
UTREE1	URBAN AND COMMUNITY FORESTRY	02	110,000	-	110,000
UTREE1 Total			110,000	-	110,000
Grand Total			7,695,000	539,409	7,155,591
Data Source: CFO Solve					
FY16, Month 03, AY16, Appr Fund 0200, Agy Fund 8200					

Agency	Contract Number	Contractor	Nature of contract, including the end product or service	Dollar Amount Awarded	Funding Source	Competitive Bid? Y/N	COTR/CA	Term of Contract
DDOT	DCKA-2013-C-0047	Fort Myers Corporation	Moveable Barriers on Roosevelt Bridge	\$371,550	Local	Y	Reginald Arno	Option 2
DDOT	DCKA-2015-Q-0071	Dell Computers	Updating Dell Computer Equipment	\$318,224.54	Local	N	Khalif Hired	Exempt Comp.
DDOT	DCKA-2015-B-0088	Azteca Systems	Software Licensing	\$150,000.00	Local	N	Khalif Hired	Exempt Comp.
DDOT	DCKA-2013-C-0029	Fort Myer Construction Corporation	FY-2013 Local Sidewalk Restoration Contract, Option Year #2	\$27,300,000.00	Local	Y	Robert Horton	365 calendar days
DDOT	DCKA-2013-C-0141	M. C. Dean Inc.	FY-13 Citywide Traffic Signal System Maintenance, Option Year #2	\$7,218,225.85	FHWA	Y	Randolph Cooper	365 calendar days
DDOT	DCKA-2015-A-0087	Saf-Gard Shoe Company	Safety Boots and Shoes	\$100,000.00	local	Y	Andrian Bulluck	365 calendar days
DDOT	DCKA-2015-B-0039	Insight LLC	Utility Marking Citywide	\$884,000.00	Local	Y	Robert Walker	365 calendar days
DDOT	DCKA-2015-B-0072	C&D Tree Service	FY-2015 Tree Asset Management Citywide	\$8,391,600.00	FHWA	Y	Earl Eutsler	730 calendar day
DDOT	DCKA-2010-Q-0052	Sabra-Wang	Citywide Traffic Signal Optimization Contract (option Year #4)	\$6,000,000.00	FHWA	Y	Wasim Raja	365 calendar days
DDOT	DCKA-2015-C-0001	Capitol Paving of DC, Inc.	FY-15 Federal Aid Pavement Restoration (NHS) Routes (Base Year)	\$10,545,955.40	FHWA	Y	Olaroe Olusegun	180 Calendar days
DDOT	DCKA-2012-C-0070	M.C. Dean	Federal Aid Citywide Streetlight Construction Contract (Partial Option Year #3)	\$1,143,192.95	FHWA	Y	Jami Abdi	365 calendar days
DDOT	DCKA-2015-C0011	Howard University	Research Management Interns	IDIQ	Federal	Y	Stephaine Dock	Base + 4 options
DDOT	DCKA-2013-C-0319	Toucan Printing & Promotional Products	Printing and Promotional Products	\$200,000.00	local	Y	Evain Patterson	Base + 4 options
DDOT	DCKA-2015-T-0008	McAndrew Company	Public Outreach and Campaigning	\$112,000.00	Local	Y	Evain Patterson	Base + 4 options
DDOT	DCKA-2014-D-0053-A01	Excel Tree Expert	Pruning Services	\$700,000.00	Local	Y	Earl Eutsler	Base + 4 options
DDOT	POS14941	Howard University	Data Analysis	\$450,000.00	Federal	Y	James Cheeks	1 year
DDOT	DCKA-2014-C-0023	Ft. Myer	16th Street Bridge	\$15,795,922.51	Federal	Y	Ghirmay Sibhatleab	365 calendar days
DDOT	DCKA-2014-C-0083	Ft. Myer	27th Street Bridge	\$1,398,774.90	Federal	Y	Ghirmay Sibhatleab	190 Days
DDOT	DCKA-2013-C-0132	Transcore	Advanced Traffic Management System	\$2,961,759.79	Federal	Y	Jason Tao	2 year Base/3 one year option
DDOT	DCKA-2014-C-0110	Prime Source Technologies	Permitting System	\$307,870.00	Local	N	Jose Colon	
DDOT	DCKA-2012-C-0110	Outfront Media	Bikeshare	\$3,633,400.00	Local	Y	Kim Lucas	5 year base(1) 5 year option period
DDOT	DCKA-2014-C-0083	Capitol Paving of DC, Inc.	City-wide Alley	\$5,270,770.00	Local	Y	Wolde Makinen	1 base year 4 one year option
DDOT	DCKA-2014-C-0085	Anchor	kingle Valley trail	\$5,796,730.00	Federal	Y	Ghirmay Sibhatleab	180 days
DDOT	DCKA-2013-T-0006	Mottvate	Bikeshare	\$8,972,085.74	Local	Y	Kim Lucas	1 year base 1 year option
DDOT	DCKA-2013-0131	The Desination Sales & Marketing Group	Marketing Program	\$980,000.00	Local	Y	Marina Budimir	1 year base 1 year option
DDOT	DCKA-2014-C-0076	MC Dean	Transit Priority Impenmentation	\$2,407,815.75	Federal	Y	Wasim Raja	1 year base 1 year option
DDOT	DCKA-2014-C-0062	Capitol Paving of DC	Georgia Avenue Dedicated Bus Lanes	\$3,690,538.00	Federal	Y	Deinma Jamambo	4/8/15-5/3/16
DDOT	DCKA-2014-C-0058	Capitol Paving of DC	Rehab Howard Theater/Streetscape of 7th St	\$6,128,037.00	Federal	Y	Samuel Ayodele	1/15/16-7/4/17
DDOT	DCKA-2014-C-0026	Fort Myer Construction Corporation	FY 14 Safe Routes to School	\$2,267,505.80	Federal	Y	George Branyan	8/28/15-8/27/16
DDOT	DCKA-2010-C-0194	M.C. Dean, Inc	FY 10 CW Traffic Signal Construction (Option year 4)	\$3,000,000.00	Federal	Y	M.G. Habib	4/6/15-4/5/16
DDOT	DCKA-2011-C-0059	Fort Myer Construction Corporation	FY 11 Fed Aid CW Pvmnt Restoration (option yr 4)	\$10,000,000.00	Federal	Y	Various	8/1/15-7/31/16
DDOT	DCKA-2009-C-0118	M.C. Dean, Inc	FY 09 Traffic Safety Construction	\$3,512,728.00	Federal	Y	M.G. Habib	4/7/15-4/6/16
DDOT	DCKA-2009-C-0112	M.C. Dean, Inc	FY 13 CW LED Bulb Replacement	\$318,217.35	Federal	Y	Suzette Robinson	7/25/15-7/24/16
DDOT	DCKA-2011-C-0241	CH2M Hill	AWI Program Management (Option yr 3)	\$25,000,000.00	Federal	Y	Ravindra Ganvir	5/26/15-5/25/16
DDOT	DCKA-2013-T-0048	A Morton thomas	DDOT A_Schedule Option Year 2	\$4,000,000.00	Federal	Y	Various	7/1/15-6/30/16
DDOT	DCKA-2013-T-0049	AB Consultants, Inc.	DDOT A_Schedule Option Year 2	\$2,000,000.00	Federal	Y	Various	7/1/15-6/30/16
DDOT	DCKA-2013-T-0051	AECOM	DDOT A_Schedule Option Year 2	\$6,000,000.00	Federal	Y	Various	7/21/15-7/20/16
DDOT	DCKA-2013-T-0052	Alpha Corporation	DDOT A_Schedule Option Year 2	\$2,000,000.00	Federal	Y	Various	7/1/15-6/30/16
DDOT	DCKA-2013-T-0054	AMEC	DDOT A_Schedule Option Year 2	\$2,000,000.00	Federal	Y	Various	7/21/15-7/20/16
DDOT	DCKA-2013-T-0055	Ammann & Whitney Consulting	DDOT A_Schedule Option Year 2	\$4,000,000.00	Federal	Y	Various	7/21/15-6/30/16
DDOT	DCKA-2013-T-0056	Arup USA, Inc.	DDOT A_Schedule Option Year 2	\$2,000,000.00	Federal	Y	Various	7/21/15-6/30/16
DDOT	DCKA-2013-T-0057	ATCS, PLC	DDOT A_Schedule Option Year 2	\$2,000,000.00	Federal	Y	Various	7/1/15-6/30/16
DDOT	DCKA-2013-T-0058	Athvale, Lystad & Associates	DDOT A_Schedule Option Year 2	\$2,000,000.00	Federal	Y	Various	7/1/15-6/30/16
DDOT	DCKA-2013-T-0059	Belcher Consultants	DDOT A_Schedule Option Year 2	\$2,000,000.00	Federal	Y	Various	7/23/15-7/22/16
DDOT	DCKA-2013-T-0060	Belstar, Inc.	DDOT A_Schedule Option Year 2	\$2,000,000.00	Federal	Y	Various	7/1/15-6/30/16
DDOT	DCKA-2013-T-0061	Bree & Associates	DDOT A_Schedule Option Year 2	\$2,000,000.00	Federal	Y	Various	8/20/15-8/19/16
DDOT	DCKA-2013-T-0062	Brudis and Associates	DDOT A_Schedule Option Year 2	\$4,000,000.00	Federal	Y	Various	7/1/15-6/30/16
DDOT	DCKA-2013-T-0063	Bryant Associates	DDOT A_Schedule Option Year 2	\$2,000,000.00	Federal	Y	Various	7/1/15-6/30/16
DDOT	DCKA-2013-T-0064	Cambridge Systematics	DDOT A_Schedule Option Year 2	\$2,000,000.00	Federal	Y	Various	7/1/15-6/30/16
DDOT	DCKA-2013-T-0066	CDM Smith	DDOT A_Schedule Option Year 2	\$4,000,000.00	Federal	Y	Various	8/13/15-8/12/16
DDOT	DCKA-2013-T-0067	Century Engineering	DDOT A_Schedule Option Year 2	\$2,000,000.00	Federal	Y	Various	7/1/15-6/30/16
DDOT	DCKA-2013-T-0068	CH2M Hill	DDOT A_Schedule Option Year 2	\$6,000,000.00	Federal	Y	Various	7/21/15-7/20/16
DDOT	DCKA-2013-T-0069	CKI and Associates	DDOT A_Schedule Option Year 2	\$2,000,000.00	Federal	Y	Various	7/1/15-6/30/16
DDOT	DCKA-2013-T-0070	CMTS, LLC	DDOT A_Schedule Option Year 2	\$2,000,000.00	Federal	Y	Various	8/20/15-8/19/16
DDOT	DCKA-2013-T-0071	CV, Inc.	DDOT A_Schedule Option Year 2	\$2,000,000.00	Federal	Y	Various	8/8/15-8/14-16
DDOT	DCKA-2013-T-0072	Dadson Consulting	DDOT A_Schedule Option Year 2	\$2,000,000.00	Federal	Y	Various	8/8/15-8/7/16
DDOT	DCKA-2013-T-0073	Daniel Consultants, Inc.	DDOT A_Schedule Option Year 2	\$4,000,000.00	Federal	Y	Various	7/2/15-7/1/16
DDOT	DCKA-2013-T-0074	Volkert Engineering	DDOT A_Schedule Option Year 2	\$6,000,000.00	Federal	Y	Various	7/21/15-7/20/16
DDOT	DCKA-2013-T-0075	DBI Architects, Inc.	DDOT A_Schedule Option Year 2	\$2,000,000.00	Federal	Y	Various	7/2/15-7/1/16
DDOT	DCKA-2013-T-0076	Delon Hampton	DDOT A_Schedule Option Year 2	\$2,000,000.00	Federal	Y	Various	7/2/15-7/1/16
DDOT	DCKA-2013-T-0078	Dewberry	DDOT A_Schedule Option Year 2	\$2,000,000.00	Federal	Y	Various	7/21/15-7/20/16
DDOT	DCKA-2013-T-0079	EBA Engineering, Inc.	DDOT A_Schedule Option Year 2	\$2,000,000.00	Federal	Y	Various	7/2/15-7/1/16
DDOT	DCKA-2013-T-0080	Enterprise Information Solutions	DDOT A_Schedule Option Year 2	\$2,000,000.00	Federal	Y	Various	7/2/15-7/1/16
DDOT	DCKA-2013-T-0081	Foursquare Integrated Transportation	DDOT A_Schedule Option Year 2	\$2,000,000.00	Federal	Y	Various	8/20/15-8/19/16
DDOT	DCKA-2013-T-0082	Geoconcepts Engineering, Inc.	DDOT A_Schedule Option Year 2	\$2,000,000.00	Federal	Y	Various	7/2/15-7/1/16
DDOT	DCKA-2013-T-0083	Stantec Consulting	DDOT A_Schedule Option Year 2	\$4,000,000.00	Federal	Y	Various	9/3/15-9/2/16
DDOT	DCKA-2014-T-0085	Greening Urban LLC	DDOT A_Schedule Option Year 2	\$2,000,000.00	Federal	Y	Various	9/3/15-9/2/16
DDOT	DCKA-2013-T-0086	Grice Consulting	DDOT A_Schedule Option Year 2	\$2,000,000.00	Federal	Y	Various	10/7/15-10/6/16
DDOT	DCKA-2013-T-0087	Haley & Aldrich, Inc.	DDOT A_Schedule Option Year 2	\$2,000,000.00	Federal	Y	Various	7/2/15-7/1/16
DDOT	DCKA-2013-T-0088	Hardesty & Hanover	DDOT A_Schedule Option Year 2	\$2,000,000.00	Federal	Y	Various	7/2/15-7/1/16
DDOT	DCKA-2013-T-0089	HDR Engineering	DDOT A_Schedule Option Year 2	\$4,000,000.00	Federal	Y	Various	7/2/15-7/1/16
DDOT	DCKA-2013-T-0090	HNTB	DDOT A_Schedule Option Year 2	\$6,000,000.00	Federal	Y	Various	7/2/15-7/1/16
DDOT	DCKA-2013-T-0091	H S A, Inc.	DDOT A_Schedule Option Year 2	\$2,000,000.00	Federal	Y	Various	7/2/15-7/1/16
DDOT	DCKA-2013-T-0093	Jacos Engineering	DDOT A_Schedule Option Year 2	\$6,000,000.00	Federal	Y	Various	7/2/15-7/1/16
DDOT	DCKA-2013-T-0094	J-Dos Internationale	DDOT A_Schedule Option Year 2	\$2,000,000.00	Federal	Y	Various	7/21/15-7/20/16
DDOT	DCKA-2013-T-0096	Johnson Mirmiran & Thompson	DDOT A_Schedule Option Year 2	\$4,000,000.00	Federal	Y	Various	7/2/15-7/1/16

DDOT	DCKA-2013-T-0097	KCI Associates of DC	DDOT A_Schedule Option Year 2	\$6,000,000.00	Federal	Y	Various	7/21/15-7/20/16
DDOT	DCKA-2013-T-0099	Kimley-Horn & Associates	DDOT A_Schedule Option Year 2	\$4,000,000.00	Federal	Y	Various	8/8/15-8/7/16
DDOT	DCKA-2013-T-0100	Kittelson & Associates	DDOT A_Schedule Option Year 2	\$4,000,000.00	Federal	Y	Various	7/2/15-7/1/16
DDOT	DCKA-2013-T-0101	KLS Engineering LLC	DDOT A_Schedule Option Year 2	\$2,000,000.00	Federal	Y	Various	7/2/15-7/1/16
DDOT	DCKA-2013-T-0102	Kumi Construction Management Corp.	DDOT A_Schedule Option Year 2	\$2,000,000.00	Federal	Y	Various	8/9/15-8/8/16
DDOT	DCKA-2013-T-0103	Legion Design	DDOT A_Schedule Option Year 2	\$2,000,000.00	Federal	Y	Various	8/8/15-8/7/16
DDOT	DCKA-2013-T-0105	Louis Berger Group	DDOT A_Schedule Option Year 2	\$4,000,000.00	Federal	Y	Various	7/2/15-7/1/16
DDOT	DCKA-2013-T-0106	Low Impact Development Center	DDOT A_Schedule Option Year 2	\$2,000,000.00	Federal	Y	Various	7/2/15-7/1/16
DDOT	DCKA-2013-T-0107	LTK Engineering	DDOT A_Schedule Option Year 2	\$2,000,000.00	Federal	Y	Various	8/8/15-8/7/16
DDOT	DCKA-2013-T-0108	McCormick Taylor Engineers	DDOT A_Schedule Option Year 2	\$2,000,000.00	Federal	Y	Various	7/2/15-7/1/16
DDOT	DCKA-2013-T-0109	McKissack & McKissack	DDOT A_Schedule Option Year 2	\$4,000,000.00	Federal	Y	Various	7/21/15-7/20/16
DDOT	DCKA-2013-T-0110	Mercado Associates	DDOT A_Schedule Option Year 2	\$2,000,000.00	Federal	Y	Various	7/2/15-7/1/16
DDOT	DCKA-2013-T-0111	Modjeski and Masters	DDOT A_Schedule Option Year 2	\$4,000,000.00	Federal	Y	Various	7/2/15-7/1/16
DDOT	DCKA-2013-T-0112	Moody Nolan DC	DDOT A_Schedule Option Year 2	\$2,000,000.00	Federal	Y	Various	7/24/15-7/23/16
DDOT	DCKA-2013-T-0113	Nelson/Nygaard Consulting	DDOT A_Schedule Option Year 2	\$2,000,000.00	Federal	Y	Various	7/21/15-7/20/16
DDOT	DCKA-2013-T-0114	Nspiregreen LLC	DDOT A_Schedule Option Year 2	\$2,000,000.00	Federal	Y	Various	7/2/15-7/1/16
DDOT	DCKA-2013-T-0115	Parsons Brinckerhoff	DDOT A_Schedule Option Year 2	\$6,000,000.00	Federal	Y	Various	7/2/15-7/1/16
DDOT	DCKA-2013-T-0116	Parsons Transportation Group	DDOT A_Schedule Option Year 2	\$6,000,000.00	Federal	Y	Various	7/2/15-7/1/16
DDOT	DCKA-2013-T-0117	Pennoni Associates, Inc.	DDOT A_Schedule Option Year 2	\$2,000,000.00	Federal	Y	Various	7/21/15-7/20/16
DDOT	DCKA-2013-T-0118	Precision Systems, Inc.	DDOT A_Schedule Option Year 2	\$4,000,000.00	Federal	Y	Various	7/21/13-7/20/14
DDOT	DCKA-2013-T-0119	Prime Engineering, Inc.	DDOT A_Schedule Option Year 2	\$2,000,000.00	Federal	Y	Various	7/2/15-7/1/16
DDOT	DCKA-2013-T-0120	PRR, Inc	DDOT A_Schedule Option Year 2	\$2,000,000.00	Federal	Y	Various	7/21/15-7/20/16
DDOT	DCKA-2013-T-0121	R. McGhee & Associates	DDOT A_Schedule Option Year 2	\$2,000,000.00	Federal	Y	Various	7/21/15-7/20/16
DDOT	DCKA-2013-T-0122	Rajah Mahima Associates	DDOT A_Schedule Option Year 2	\$2,000,000.00	Federal	Y	Various	8/21/15-8/20/16
DDOT	DCKA-2013-T-0123	Rhodeside and Harwell	DDOT A_Schedule Option Year 2	\$2,000,000.00	Federal	Y	Various	7/2/15-7/1/16
DDOT	DCKA-2013-T-0125	Rice Associates	DDOT A_Schedule Option Year 2	\$2,000,000.00	Federal	Y	Various	7/2/15-7/1/16
DDOT	DCKA-2013-T-0126	Rummel Kleppher & Kahl	DDOT A_Schedule Option Year 2	\$6,000,000.00	Federal	Y	Various	7/2/15-7/1/16
DDOT	DCKA-2013-T-0127	Sabra Wang & Associates	DDOT A_Schedule Option Year 2	\$4,000,000.00	Federal	Y	Various	7/2/15-7/1/16
DDOT	DCKA-2013-T-0128	LEIDOS	DDOT A_Schedule Option Year 2	\$4,000,000.00	Federal	Y	Various	8/8/15-8/7/16
DDOT	DCKA-2013-T-0129	Sam Schwartz Engineering	DDOT A_Schedule Option Year 2	\$2,000,000.00	Federal	Y	Various	7/24/15-7/23/16
DDOT	DCKA-2013-T-0131	Sharp and Company, Inc.	DDOT A_Schedule Option Year 2	\$2,000,000.00	Federal	Y	Various	7/24/15-7/23/16
DDOT	DCKA-2013-T-0132	Sheladia Associates	DDOT A_Schedule Option Year 2	\$4,000,000.00	Federal	Y	Various	7/21/15-7/20/16
DDOT	DCKA-2013-T-0133	Shrewsbury & Associates LLC	DDOT A_Schedule Option Year 2	\$2,000,000.00	Federal	Y	Various	7/23/15-7/22/16
DDOT	DCKA-2013-T-0134	Sorg Architects	DDOT A_Schedule Option Year 2	\$2,000,000.00	Federal	Y	Various	7/2/15-7/1/16
DDOT	DCKA-2013-T-0135	STV	DDOT A_Schedule Option Year 2	\$4,000,000.00	Federal	Y	Various	7/2/15-7/1/16
DDOT	DCKA-2013-T-0136	T3 Design	DDOT A_Schedule Option Year 2	\$2,000,000.00	Federal	Y	Various	8/20/15-8/19/16
DDOT	DCKA-2013-T-0137	The Temple Group	DDOT A_Schedule Option Year 2	\$2,000,000.00	Federal	Y	Various	7/2/15-7/1/16
DDOT	DCKA-2013-T-0139	Toole Design Group	DDOT A_Schedule Option Year 2	\$2,000,000.00	Federal	Y	Various	7/2/15-7/1/16
DDOT	DCKA-2013-T-0140	Triad Engineering, Inc.	DDOT A_Schedule Option Year 2	\$2,000,000.00	Federal	Y	Various	7/2/15-7/1/16
DDOT	DCKA-2013-T-0141	TY Lin International	DDOT A_Schedule Option Year 2	\$2,000,000.00	Federal	Y	Various	7/21/15-7/20/16
DDOT	DCKA-2013-T-0142	Urban Engineers, Inc.	DDOT A_Schedule Option Year 2	\$2,000,000.00	Federal	Y	Various	9/23/15-9/22/16
DDOT	DCKA-2013-T-0143	URS Corporation	DDOT A_Schedule Option Year 2	\$6,000,000.00	Federal	Y	Various	7/2/15-7/1/16
DDOT	DCKA-2013-T-0144	Vanase hangen Brustlin, Inc.	DDOT A_Schedule Option Year 2	\$4,000,000.00	Federal	Y	Various	7/2/15-7/1/16
DDOT	DCKA-2013-T-0145	Wallace Montgomery	DDOT A_Schedule Option Year 2	\$2,000,000.00	Federal	Y	Various	7/2/15-7/1/16
DDOT	DCKA-2013-T-0146	Whitman, Reardon & Associates LLP	DDOT A_Schedule Option Year 2	\$2,000,000.00	Federal	Y	Various	7/2/15-7/1/16
DDOT	DCKA-2013-T-0147	Wiles Mensch Corporation	DDOT A_Schedule Option Year 2	\$2,000,000.00	Federal	Y	Various	7/2/15-7/1/16
DDOT	DCKA-2013-T-0148	ZGF Architects	DDOT A_Schedule Option Year 2	\$2,000,000.00	Federal	Y	Various	7/21/15-7/20/16
	DCKA-2012-C-0049	Oregon Iron Works	Design, Manufacture, Test and Delivery of Two Streetcar Vehicles Modification #10	\$8,686,792.00	Local	N	Ralph Burns	2/29/2016
	DCKA-2012-C-0085	Oregon Iron Works	design, Manufacture, Test and Delivery of One Streetcar Vehicles	\$2,920,091.00	Local	N	Ralph Burns	9/30/2015
	DCKA-2014-C-0075	MC Dean	Emergency Communications in the Mall Tunnel	\$5,483,588.90	Local	Y	Abdullahi Mohammed	180 calendar days
	DCKA-2014-C-0027	Fort Myer Construction Corp.	Federal Aid Preventive Maintenance	\$7,253,470.75 Base	Federal	Y	Yared Tesfaye	Base 730 Calendar days
	DCKA-2015-C-0033	Don's Johns	Water/Sewer Service at DC Streetcar Training Facility	\$142,323.82	Local	N	Victory Rich	365 Calendar days
	DCKA-2014-C-0067	MC DEAN, INC.	Asset Management of District's Lighting System	\$530,449.75	FHWA	Y	JAMA ABDI	1/12/15 THRU 3/12/15
	DCKA-2012-C-0088	HNTB District of Columbia	Construction Management Services (CMS) 11th Street Bridge	\$581,126.44	FHWA	Y	RAVINDRA GANVIR	7/1/2015 THRU 1/31/2016
	DCKA-2013-C-0135	State of Maryland - Office of Research Admin & Advancement	Metropolitan Area Transportation Operations Coordination (MATOC)- Program Support &	\$400,000.00	FHWA	N	Makan Abousaedi	11/7/2014 THUR 11/6/2015
	DCKA-2014-C-0055	International Road Dynamics	WEIGH-IN-MOTION (WIM) STATIONS MAINTENANCE CONTRACT	\$100,912.00	FHWA	N	Rahul Jain	1/10/2016 THUR 7/8/2016
	DCKA-2014-C-0067	MC DEAN, INC.	Asset Management of District's Lighting System	\$315,018.00	FHWA	Y	JAMA ABDI	10/1/2015 THRU 10/31/2015
	DCKA-2014-C-0067	MC DEAN, INC.	Asset Management of District's Lighting System	\$833,273.43	FHWA	Y	JAMA ABDI	7/11/2015 THRU 9/30/2015
	DCKA-2014-C-0067	MC DEAN, INC.	Asset Management of District's Lighting System	\$457,284.10	FHWA	Y	JAMA ABDI	5/12/2015 THRU 7/10/2015
	DCKA-2014-C-0067	MC DEAN, INC.	Asset Management of District's Lighting System	\$719,460.35	FHWA	Y	JAMA ABDI	11/12/2014 THRU 1/11/2015
	DCKA-2014-C-0067	MC DEAN, INC.	Asset Management of District's Lighting System	\$487,769.90	FHWA	Y	JAMA ABDI	3/13/2015 THRU 5/11/2015
	DCKA-2014-C-0067	MC DEAN, INC.	Asset Management of District's Lighting System	\$530,449.75	FHWA	Y	JAMA ABDI	1/12/2015 THRU 3/11/2015
	DCKA-2014-C-0067	MC DEAN, INC.	Asset Management of District's Lighting System	\$934,892.13	FHWA	Y	JAMA ABDI	11/1/2015 THRU 1/31/2016
	DCKA-2014-C-0067	MC DEAN, INC.	Asset Management of District's Lighting System	\$719,460.35	FHWA	Y	JAMA ABDI	11/21/2014 THUR 1/20/2015
	DCKA-2011-C-0026	PARKMOBILE USA, INC.	Cellular Phone Payment Method for Digital Parking Meters	N/A	Local	Y	EVIAN PATTERSON	4/21/2015 THRU 6/21/2016

Question 20 - Agency FY2015 Surplus
 Department of Transportation (KA0)
 FY 2015 Budget Balance Explanations

Local Fund

APPR FUND 0100 CSG	FY15 Budget	FY15 Expenditures	Variance	Comments
0011 - 0015	\$ 42,836,834	\$ 42,616,557	\$ 220,277	Balance is due to turnover for administrative support staff.
PS	\$ 42,836,834	\$ 42,616,557	\$ 220,277	
0020	\$ 1,081,770	\$ 970,007	\$ 111,763	Balance is due to lower than anticipated cost for uniforms for Transportation Operations field workers.
0030	\$ 8,105,489	\$ 7,977,175	\$ 128,314	Balance is due to lower than anticipated utility cost.
0040	\$ 6,053,918	\$ 5,871,760	\$ 182,158	Balance is due to lower than anticipated cost for maintenance of snow vehicles and for traffic control services.
0041	\$ 18,327,802	\$ 17,404,476	\$ 923,326	Variance of \$700k of fund 100 NPS due to contractual savings for parking operations and street & bridge maintenance.
0050	\$ 100,386	\$ 100,000	\$ 386	
0070	\$ 138,918	\$ 109,757	\$ 29,161	Balance is due to lower than anticipated cost for equipment purchases.
NPS	\$ 33,808,283	\$ 32,433,175	\$ 1,375,108	
Total	\$ 76,645,117	\$ 75,049,732	\$ 1,595,385	

Federal Grant Fund

APPR FUND 0200	FY15 Budget	FY15 Expenditures	Variance	Comments
200	\$ 5,197,594	\$ 5,197,544	\$ 50	Balance is due to a reversal of an expense that occurred after the grant modification package was approved and budget was reduced to equal expenditures.

Special Purpose Revenue Fund

APPR FUND 0600	FY15 Budget	FY15 Expenditures	Variance	Comments
0600	\$ 13,709,740	\$ 11,258,388	\$ 2,451,352	Variance of \$1.1M of NPS SPR fund 6901 due to timing of funding awards within the Agency. In FY2016, a more rigorous spend plan in place and currently 90% of funding for fund 6901 has been expended or obligated. Variance of \$1.3M of authority was left in fund 6909 Transportation Mitigation Fund.

*Variance Description formatted to include response from Resource Management.

Question 25 - MOUs

Request Date	Buyer Agency	Seller Agency	Description of Service	Amount
July 30, 2015	DDOT	DDOE	To install stormwater reduction devices and technologies in the public space	\$ -
August 4, 2015	OP	DDOT	Implementation of Sustainable DC Innovation Challenge, Pavers on CT Ave, NW	\$ 50,000.00
August 11, 2015	DDOT	OP/SHPO	Amendment - Expedited review of DDOT projects for fiscal Year 2016	\$ 140,000.00
August 20, 2015	DDOT	OCFO	Funding for one FTE for OCFO to collect public space surface rental bills in FY15	\$ 109,434.42
September 15, 2015	DDOT	DGS	To perform preliminary work to quantify the risks associated with proposed development of the green space along PA AVE	\$ 200,000.00
October 6, 2015	DDOT	DCCAH	Provide DCCAH assistance with an art event called Art All Night	\$ 3,147.00
October 24, 2015	DDOT	JR0	For cost of sign language interoperation services from ODR	\$ 3,000.00
October 27, 2015	DDOT	OCME	The OCME employ one FTE who will perform necessary toxicology casework and improve the chemical testing knowledge base	\$ 165,000.00
November 4, 2015	DDOT	DCHR	To provide funding for the Capital Fellows Program in FY16	\$ 112,697.00
November 4, 2015	DDOT	FEMS	To upgrade the existing FEMS simulator so that it can mimic various District Traffic & other incident scenarios	\$ 351,048.54
November 4, 2015	DDOT	OAG	Administrative costs, courier and transportation, and telecommunication services	\$ 162,000.00
December 17, 2015	DDOT	OAG	Administrative costs, courier and transportation, and telecommunication services	\$ 392,000.00
December 23, 2015	DDOT	MPD	For various safety related enforcement activities and to include DUI enforcements and pedestrian safety initiatives	\$ 2,745,595.63
January 6, 2016	DPW	OSSE	DDOT will provide training and review applicable invoices	\$ -
February 3, 2016	DDOT	DCTC	DC Taxicab Commission will provide service of taxi trips to & from eligible facilities for district residents enrolled in MetroAccess	\$ 2,800,000.00
August 3, 2015	DDOE	DDOT	Clean Water Act State Revolving Fund Projects	\$ 3,780,774.00
February 11, 2016	DDOT	OUC	Citywide Radio System, Computer-Aided Dispatch and Mobile Data Services	\$ 51,502.81

27. AUDITS, REVIEWS, EVALUATIONS

Issuing Entity	Report Number	Date Issued	Report Title	Description
OIG	OIG No. 14-1-23KA	January-15	District Department of Transportation - Highway Trust Fund Financial Statement Audit - For the Fiscal Year Ended September 30, 2014	OIG audit of the Highway Trust Fund, which is administered by the District of Columbia Department of Transportation as of and for the year ended September 30, 2014. These financial statements are the responsibility of the Highway Trust Fund's management and the Office of the Chief Financial Officer. Our responsibility is to express an opinion on these financial statements based on our audit.
APTA	n/a	April-15	Report of the APTA Peer Review Panel on the Streetcar Service Readiness	The Agency requested a peer review from APTA to evaluate DC Streetcar Program service readiness.
OIG	OIG NO. 14-1-23KA(a)	June-15	District Department of Transportation - Report on the Examination of the District of Columbia Highway Trust Fund's Forecast Statements for Fiscal Years 2015-2019 With Actual Audited Figures for Fiscal Year 2014	A report summarizing the results of the OIG's Examination of the Highway Trust Fund's 5-year forecast expenditure conditions and operations.
DC Auditor	DCA042016	January-16	Status Report on Implementation of District of Columbia Auditor Recommendations	The purpose of this report is to make public the implementation status of the recommendations DC Auditor have made to District of Columbia government agencies in their audit reports.
OIG	OIG No. 15-1-21KA	January-16	District Department of Transportation - Highway Trust Fund Financial Statement Audit - For the Fiscal Year Ended September 30, 2015	OIG audit of the Highway Trust Fund, which is administered by the District of Columbia Department of Transportation as of and for the year ended September 30, 2014. These financial statements are the responsibility of the Highway Trust Fund's management and the Office of the Chief Financial Officer. Our responsibility is to express an opinion on these financial statements based on our audit.
FTA	FTA SMR	January-16	FTA State Management Review	The Federal Transit Administration (FTA) conducted a State Management Review of the District DOT. The review assesses management practices and program implementation to ensure that the FTA programs are administered in accordance with 49 U.S.C. Chapter 53, Federal transit law provisions, and FTA requirements and are meeting program objectives.

DDOT Admin	Report Date	Report Number	Report Title	Issue	Issuing Entity	Compliance Status	Recommendation Summary	Estimated Completion Date/Date Resolved	Status of Implementation
IPMA	January-13	OIG No.11-2-28KA	MANAGEMENT ALERT REPORT ON DDOT'S INVENTORY OF CAPITAL EQUIPMENT	Capital Equipment	OIG	Closed	1) Take immediate possession of the District-owned barrier moving machine from the contractor. 2) Determine whether to surplus the barrier moving machines and offer them for sale. 3) Conduct a complete inventory of all construction capital equipment. 4) Discontinue the practice of allowing contractors to use District-owned equipment by lease or any other means without appropriate documentation of terms and conditions in a contract issued by the DDOT chief contracting officer. The documentation is essential for monitoring and oversight to ensure payment and other terms of the agreement are complied with. 5) Develop written procedures to implement adequate internal controls for the control of fixed assets. The procedures should provide guidance for allowing contractors to utilize District-owned equipment when government furnished equipment is not included in the solicitation or invitation for bid. 6) Recover payment for equipment rental using the verified period of equipment use and the complete offer made by the contractor for the rental of both DDOT-owned barrier moving machines and equipment.	Completed	The equipment was sold by the District. DDOT has a complete inventory of all construction Capital Equipment. DDOT does not rent equipment to contractor anymore. The contractor has paid the District for the use of the DDOT owned barrier moving machines.
OCFO	February-13	OIG No. 12-1-13KA	DISTRICT OF COLUMBIA HIGHWAY TRUST FUND	Highway Trust Fund	OIG	Closed	None	N/A	N/A
Civil Rights	July-13	HAD-DC	TITLE VI/NON DISCRIMINATION COMPLIANCE REVIEW	Reporting Requirements	FHWA	Open	1. DDOT must ensure that the office of ROW manager is sufficiently trained to effectively fulfill her duties and that ROW activities are integrated into DDOT's project development phase in time for the initiation of projects in 2013. 2. DDOT must revise existing operations manuals (design & engineering and environment) to include more specific procedures regarding conducting community outreach and for public involvement and participation. These processes must be referenced in the participation plan section of the Title VI/Nondiscrimination plan. 3. DDOT and COG do not presently collect demographic information (age, sex, national origin, color, disability etc.) DDOT must ensure that all Title VI/Nondiscrimination program related population data is being collected. 4. DDOT must develop an effective annual PAR program, include the program as part of the Title VI/Nondiscrimination plan, and integrate the PAT program into the program areas. 5. DDOT's call center must use the LEP Four fact analysis results to determine if 311 service messages need to be provided in on or more additional languages (Executive Order #13166) 6. DDOT must develop a process to periodically evaluate the effectiveness of the criteria used in each of the approximately 14 categories to determine if otherwise eligible firms are not included in the A&E schedule. 7. DDOT must update the Title VI/Nondiscrimination policy statement to identify the Title VI/Nondiscrimination coordinator and explicitly communicate that DDOT's Associate Directors have been delegated authority and responsibility to effectively implement Title VI/Nondiscrimination requirements through the program areas of each AD. Additionally, DDOT must provide the Title VI/Nondiscrimination policy statement to participants of the Title VI/Nondiscrimination training provided by the training department (DDOT's).	FY2016	A corrective action plan was submitted to FHWA on 10/9/2013. This plan will correct all the identified deficiencies through the year 2015.
ASA	August-13	FY2013-010	DCHR AUDIT REPORT Q1 & 2 FY 2013	Hiring Practices	DCHR	Open	1) Incomplete merit staffing case files Recommendation: Include all needed documentation in MSCF 2) Discrepancies in the vacancy announcements Recommendation: Implement a more thorough check for accuracy 3) Incomplete OPF's Recommendation: Implementation of effective filing process (DCHR Recommendation)	Completed	Finding #1: DDOT's ASA recruiters currently use the checklist to ensure that all required documents are included in the MSCF. All MSCFs are reviewed by a designated support staff to assure all required documents are included before the MSCFs are filed and closed out. As a result of the findings of this audit, we are currently including the DCSF-62 in all interview packages that are prepared for the panelist to complete. Finding #2: As a result of the audit findings, all postings are assigned to three ASA staff, serving in the role of originator, recruiter and approver. This will ensure that the postings are reviewed for accuracy by three individuals before the announcement is posted on DCHR's website. This will help prevent the omission of pertinent information in our job postings. Finding #3: This is a DCHR recommendation
OD	January-14	OIG No. 13-1-28KA	HIGHWAY TRUST FUND FINANCIAL STATEMENT AUDIT FOR THE FISCAL YEAR ENDED SEPTEMBER 30, 2013	Highway Trust Fund	OIG	Closed	OIG examination included a review of existing processes, policies, and controls for the purpose of expressing an opinion on the accompanying forecasted statements. Although OIG found no instances of noncompliance that would be reportable under generally accepted government auditing standards, the objective of our review was not to provide an opinion on overall compliance with such provisions.	N/A	N/A
ASA	April-14	OIG No. 12-1-13KA(b)	HIGHWAY TRUST FUND MEMORANDUM OF RECOMMENDATIONS FOR FY ENDED 9/30/12	Contract duplicate payment	OIG	Closed	1. Initiate the process to seek reimbursement from FHWA in the amount of \$307,322 (or 83.15% of \$369,600) for the portion of the federal financial participation (FFP) disallowed by FHWA for project STP 8888(269) for payment to the contractor that DDOT determined was not duplicated.	Completed	No status required
IPMA	April-14	OIG No. 12-1-13KA(b)	HIGHWAY TRUST FUND MEMORANDUM OF RECOMMENDATIONS FOR FY ENDED 9/30/12	Internal control deficiencies in management of federal-aid projects	OIG	Closed	2. Establish adequate internal controls to ensure that new processes and procedures recently put in place, through the Construction Management Manual, are sufficient to timely identify and correct errors. 3. Maintain and make available for review upon request, a record of training provided to project management staff and contract administration personnel to ensure compliance with the Construction Management Manual and effective management of construction projects. 4. Ensure compliance with DDOT's requirements governing change orders.	Completed	No status required

DDOT Admin	Report Date	Report Number	Report Title	Issue	Issuing Entity	Compliance Status	Recommendation Summary	Estimated Completion Date/Date Resolved	Status of Implementation
IPMA	April-14	OIG No. 12-1-13KA(b)	HIGHWAY TRUST FUND MEMORANDUM OF RECOMMENDATIONS FOR FY ENDED 9/30/12	Project files missing supporting documentation	OIG	Unresolved	5. Seek assistance from FHWA regarding design costs approved in Report FMISD05A for 8888(171) for Dalecarlia and any documentation supporting the FHWA Area Engineer's decisions related to this project. If there is no documentation evidencing the FHWA Area Engineer's disapproval, DDOT should initiate the process to seek reimbursement from FHWA in the amount of \$77,043 (or 83.15% of \$92,655) for FFP.	TBD	Although FHWA agreed to the initial overall scope of the project and its estimated cost, as outlined in Report FMISD05A for 8888(171), the design cost in question was beyond this initial decision to obligate federal funds. In order to be eligible for reimbursement, the design costs would have been required to be part of an approved Form 1365, and neither DDOT or FHWA can find evidence that the work was covered by a Form 1365. As a result FHWA provided written notice on July 28, 2008, that it would not participate.
IPMA	April-14	OIG No. 12-1-13KA(b)	HIGHWAY TRUST FUND MEMORANDUM OF RECOMMENDATIONS FOR FY ENDED 9/30/12	Project files missing supporting documentation	OIG	Open	6. Ensure compliance with DDOT's CM regarding maintenance of contract files.	In Progress	Begin necessary further investigation and determine appropriate action March 2, 2015
OCFO	April-14	OIG No. 12-1-13KA(b)	HIGHWAY TRUST FUND MEMORANDUM OF RECOMMENDATIONS FOR FY ENDED 9/30/12	Rights-of-way revenue policies and procedures have not been revised to incorporate changes in governing legislation	OIG	Unresolved	7. Revise the Rights-of-Way Policies and Procedures to reflect current law governing the HTF.	Completed	Previous procedures rescinded. T the amount of Rights-of Way revenue transferred to the HTF annually is determined by BSA legislation, with a one time annual transfer to the HTF once sufficient rights-of way revenue is received.
OCFO	April-14	OIG No. 12-1-13KA(b)	HIGHWAY TRUST FUND MEMORANDUM OF RECOMMENDATIONS FOR FY ENDED 9/30/12	Rights-of-way revenue policies and procedures have not been revised to incorporate changes in governing legislation	OIG	Unresolved	8. Monitor the recording of ROW rental fees to ensure that ROW revenue is deposited into the correct account.	Completed	Previous procedures rescinded. T the amount of Rights-of Way revenue transferred to the HTF annually is determined by BSA legislation, with a one time annual transfer to the HTF once sufficient rights-of way revenue is received. Rights of Way fees are always deposited to the DC Custodial Bank account and recorded as rights of way revenue in the KZ0-Transfer Agency.
OCP	April-14	OIG No. 12-1-13KA(b)	HIGHWAY TRUST FUND MEMORANDUM OF RECOMMENDATIONS FOR FY ENDED 9/30/12	Contract files lack evidence of compliance with certain provisions of procurement laws and regulations	OIG	Open	9. Ensure compliance with procurement laws and regulations.	In Progress	Begin necessary further investigation and determine appropriate action March 2, 2015
OCP	April-14	OIG No. 12-1-13KA(b)	HIGHWAY TRUST FUND MEMORANDUM OF RECOMMENDATIONS FOR FY ENDED 9/30/12	Contract files lack evidence of compliance with certain provisions of procurement laws and regulations	OIG	Open	10. Ensure that contract files contain evidence of compliance with relevant procurement laws and regulations.	In Progress	Begin necessary further investigation and determine appropriate action March 2, 2015
OCFO	April-14	OIG No. 12-1-13KA(b)	HIGHWAY TRUST FUND MEMORANDUM OF RECOMMENDATIONS FOR FY ENDED 9/30/12	DDOT lacks controls to monitor direct labor payroll costs charged to highway trust fund projects	OIG	Closed	11. Develop, document, and implement controls for the periodic review of payroll costs to ensure that only allowable payroll costs are charged to projects.	Completed	
OCFO	April-14	OIG No. 12-1-13KA(b)	HIGHWAY TRUST FUND MEMORANDUM OF RECOMMENDATIONS FOR FY ENDED 9/30/12	DDOT-OCFO recorded DC water advance for project in wrong fund	OIG	Closed	12. Monitor activity posted to the HTF to ensure it is in accordance with established budget authority.	Completed	
OCFO	April-14	OIG No. 12-1-13KA(b)	HIGHWAY TRUST FUND MEMORANDUM OF RECOMMENDATIONS FOR FY ENDED 9/30/12	Incorrect cost allocation overhead posting	OIG	Closed	13. Adhere to established policies and procedures to ensure that cost allocation journal entries posted to SOAR are correct; and 14. Ensure that entries submitted to OFOS for processing are correctly recorded in SOAR.	Completed	This was a one time error when OFOS posted an incorrect upload batch and the error was not detected. . Accounting staff now reviews the entry once upload is completed to ensure that no error has been made prior to posting.
OCFO	April-14	OIG No. 12-1-13KA(b)	HIGHWAY TRUST FUND MEMORANDUM OF RECOMMENDATIONS FOR FY ENDED 9/30/12	Incorrect classification of motor fuel tax refunds due	OIG	Open	15. Develop clear and concise policies and procedures to ensure that refunds owed by the HTF are correctly classified in SOAR and incorporate the new procedure(s) in the OTR section of the HTF's Revenue Cycle Memorandum that outlines current revenue controls, policies, and procedures.	TBD	
IPMA	April-14	OIG No. 11-2-28KA(b)	AUDIT OF CONSTRUCT MANAGEMENT AT THE DISTRICT DEPARTMENT OF TRANSPORTATION	Compliance, internal control, and economy and efficiency	OIG	Closed	Incorporate the construction management manual in all construction management contracts and amend existing contracts to incorporate the manual.	Completed	Implemented
IPMA	April-14	OIG No. 11-2-28KA(b)	AUDIT OF CONSTRUCT MANAGEMENT AT THE DISTRICT DEPARTMENT OF TRANSPORTATION	Compliance and internal control	OIG	Closed	Develop a procedure to standardize the initial CM meeting to ensure that adequate documentation systems are designed and implemented for construction projects, and require that the results of the meeting be documented in the construction management project files	Completed	Implemented Procedures
IPMA	April-14	OIG No. 11-2-28KA(b)	AUDIT OF CONSTRUCT MANAGEMENT AT THE DISTRICT DEPARTMENT OF TRANSPORTATION	Compliance, internal control, and economy and efficiency	OIG	Closed	Implement a program to develop or enhance project engineer skills that are necessary to effectively oversee construction managers' documentation and inspection of construction projects. The program should require that the verification of project staff certification and experience, and the acceptance or approval of staff by DDOT's Engineer or his/her representative be documented in the project files.	Completed	Implemented Program
IPMA	April-14	OIG No. 11-2-28KA(b)	AUDIT OF CONSTRUCT MANAGEMENT AT THE DISTRICT DEPARTMENT OF TRANSPORTATION	Compliance and internal control	OIG	Open	Develop a list of the project deliverables required by each construction management contract, include them in the monthly reports, and require the CM to address the status of each deliverable in the monthly report.	In Progress	Monthly reports are required on all CM managed construction projects and is ongoing. DDOT also implemented a standard IDR form that captures critical project information on a daily basis. Document management system is developed and being utilized. Additional efforts such as revising DDOT manuals are ongoing. Draft CM check list is under discussion and will be implemented
IPMA	April-14	OIG No. 11-2-28KA(b)	AUDIT OF CONSTRUCT MANAGEMENT AT THE DISTRICT DEPARTMENT OF TRANSPORTATION	Economy and Efficiency	OIG	Open	Require IPMA approval on contract deliverables included in construction contracts and establish periodic reviews to eliminate or reduce unnecessary contract deliverables as project wind down to completion.	In Progress	CMs are required to document and/or process IDR's, reports, RFI, correspondences that will be reviewed/approved/amended by IPMA Staff. Contract Administration training was offered to all IPMA engineers. Draft CM check list is under discussion and will be implemented.
TOA	September-14	OIG No. 14-1-0063	SPECIAL EVALUATION: PARKING AND AUTOMATED TRAFFIC ENFORCEMENT TICKETS – PART I: TICKET ISSUANCE PRACTICES.	ATE Policies	OIG	Open	1. A January 2014 report to the D.C. Council, which was intended to "instill public trust that speed cameras are installed by the D.C. government to improve safety and not just increase local revenues," justified the need for speed cameras at all 241 planned/proposed locations that were studied. However, at nearly half of those locations, the 85th percentile speed—a common traffic engineering benchmark—was at or below the posted speed limit. (1) That the Chief of MPD (C/MPD) and the Director of DDOT (D/DDOT), to bolster public trust in the District's automated speed enforcement program, critically evaluate the January 2014 traffic safety study protocol and its results, and request and document further justification prior to installing ATE equipment at any of the planned or proposed locations addressed in the study.	Ongoing	Collaborated with MPD and Responded to OIG on August 20, 2014. Data is being gathered to conduct the evaluation.
TOA	September-14	OIG No. 14-1-0063	SPECIAL EVALUATION: PARKING AND AUTOMATED TRAFFIC ENFORCEMENT TICKETS – PART I: TICKET ISSUANCE PRACTICES.	ATE Policies	OIG	Open	(2) That the D.C. Council, following collaboration with MPD, DDOT, and outside subject matter experts, amend the D.C. statute that authorizes the use of ATE to: (1) require a robust justification, accompanied by traffic data, of the need for an ATE device at a planned location; (2) within a reasonable period following installation of the device, require a statistical analysis of the impact of the device on traffic safety at the location; and (3) make all of these documents readily available to the public on DDOT's website.	Ongoing	Collaborated with MPD and Responded to OIG on August 20, 2014. Data is being gathered to conduct the evaluation.

DDOT Admin	Report Date	Report Number	Report Title	Issue	Issuing Entity	Compliance Status	Recommendation Summary	Estimated Completion Date/Date Resolved	Status of Implementation
TOA	September-14	OIG No. 14-I-0063	SPECIAL EVALUATION: PARKING AND AUTOMATED TRAFFIC ENFORCEMENT TICKETS – PART I: TICKET ISSUANCE PRACTICES.	ATE Policies	OIG	Open	2. The D.C. Code and DCMR are silent with regard to other important ATE program issues that should be addressed in the statute or regulations, such as the confidentiality and retention of violation images, as well as limitations on camera operations and the information captured by them. That the D.C. Council, after conferring with MPD and DDOT, consider inserting language in the D.C. Code to codify key ATE program elements, including, but not limited to: 1) the confidentiality of and limitation on uses of all images and other information collected by the District's ATE program; 2) guidelines and timeframes for the retention and destruction of all images and videos captured by the District's program equipment; 3) limitations on the number of cameras that can be placed in the District and their hours of operation; 4) the requirement for a site-specific safety study prior to each new camera placement; and 5) the requirement for a sign at every location where ATE equipment is deployed.	Ongoing	Collaborated with MPD and Responded to OIG on August 20, 2014. Data is being gathered to conduct the evaluation.
TOA	September-14	OIG No. 14-I-0063	SPECIAL EVALUATION: PARKING AND AUTOMATED TRAFFIC ENFORCEMENT TICKETS – PART I: TICKET ISSUANCE PRACTICES.	Parking Enforcement	OIG	Open	8. TCOs lack written instructions about key facets of ticketing operations, foremost being how they should take photographs of violating vehicles, which has led to glaring inconsistencies in TCOs' ticketing practices. The OIG team also noted numerous inconsistencies between DDOT's and DPW's ticketing operations. That the D/DDOT promulgate new, comprehensive policies and procedures that address situations commonly encountered by TCOs, including but not limited to: writing a ticket for a vehicle parked at a broken meter; documenting a violation after a motorist drives away before the TCO has finished writing the ticket; testing a meter before issuing a parking ticket; and reporting a broken parking meter.	3/1/2015	Collaborated with MPD and Responded to OIG on August 20, 2014. DDOT engaged a consultant to update Standard Operating Procedures and the TCO training manual. The SOPs will incorporate guidance on how to address broken parking meters. The updated SOP and Training Manual are due to be completed in March 2015, and all TCOs will receive training.
TOA	September-14	OIG No. 14-I-0063	SPECIAL EVALUATION: PARKING AND AUTOMATED TRAFFIC ENFORCEMENT TICKETS – PART I: TICKET ISSUANCE PRACTICES.	Parking Enforcement	OIG	Open	9. TCOs are not required to take photographs that document parking and moving violations, nor do they have written procedures describing the types and number of photographs that would best support the violations they encounter. That D/DDOT promptly write and implement policies and procedures, and train TCOs on them, for photographing parking and moving violations. Further, to improve consistency and uniformity between DDOT's and DPW's ticket writing processes, D/DDOT should coordinate a review of the new policies and procedures by DPW's Parking Enforcement Management Administration. That way, regardless of whether the ticket for a particular parking violation is issued by DDOT or DPW, the photographic evidence presented to the motorist will be consistent.	3/1/2015	Collaborated with MPD and Responded to OIG on August 20, 2014. DDOT engaged a consultant to update Standard Operating Procedures and the TCO training manual. The SOPs will incorporate guidance on including photographs when citations are issued. The SOPs and updated Training Manual are due to be completed in March 2015, and all TCOs will receive training. DDOT also procured new handheld devices that have the capacity to store photographs. These are the same devices (and software) that DPW uses.
TOA	September-14	OIG No. 14-I-0063	SPECIAL EVALUATION: PARKING AND AUTOMATED TRAFFIC ENFORCEMENT TICKETS – PART I: TICKET ISSUANCE PRACTICES.	Parkmobile Policies	OIG	Closed	10. DDOT does not closely monitor transaction fees paid to Parkmobile, or track and analyze Parkmobile complaint data. That the D/DDOT establish systems and assign responsibility for monitoring on a monthly basis: (1) the transaction fees paid to Parkmobile and (2) the number and types of complaints lodged with both the District's and Parkmobile's customer service entities.	Completed	DDOT receives monthly reports regarding transaction fees that are paid to Parkmobile. In addition, DDOT requested and received a breakdown of inquiries to Parkmobile and will implement a process to receive the information on a monthly basis. The District Customer Service Center (311) forwards all complaints directly to Parkmobile.
OD	September-14	DCA262014	DISTRICT SPECIAL EVENTS PROCESSES CAN BE IMPROVED	Transparency of Fee Collection Practices	DC Auditor	Open	Auditor recommends that District Agencies establish a system to ensure that special event organizers are charged the correct fees and payments are received in a timely manner, in accordance Mayor's Special Events Task Group Planning Guide	Completed	Responses submitted to DC Auditor but response not acknowledged in Final Report
OD	September-14	DCA262014	DISTRICT SPECIAL EVENTS PROCESSES CAN BE IMPROVED	Transparency of the internal control process for special events	DC Auditor	Open	Auditor recommends that HSEMA and the agency members of the Mayor's Special Events Task Group execute proper internal controls over the special events process.	Completed	Responses submitted to DC Auditor but response not acknowledged in Final Report
PPSA	September-14	DCA292014	STATUS REPORT ON IMPLEMENTATION OF DISTRICT OF COLUMBIA AUDITOR RECOMMENDATIONS	Grant Management	DC Auditor	Closed	DDOT should strengthen its internal control environment to ensure grant-related policies and procedures address appropriate District laws and the City-Wide Sourcebook Grants Manual and Sourcebook.	Completed	According to DC Auditor - this has been 'Implemented'
PPSA	September-14	DCA292014	STATUS REPORT ON IMPLEMENTATION OF DISTRICT OF COLUMBIA AUDITOR RECOMMENDATIONS	Grant Management	DC Auditor	Closed	DDOT should ensure that grant-related policies and procedures are clearly known and implemented.	Completed	According to DC Auditor - this has been 'Implemented'
PPSA	September-14	DCA292014	STATUS REPORT ON IMPLEMENTATION OF DISTRICT OF COLUMBIA AUDITOR RECOMMENDATIONS	Grant Management	DC Auditor	Open	DDOT should ensure adherence with grant agreement terms prior to disbursing grant payments	In Progress	Agency has made necessary changes. According to DC Auditor - this is 'In Progress'. DDOT reports that this recommendation has been implemented. However, they have not provided documentary evidence to support this assertion
OD	January-15	OIG No. 14-I-23KA	DISTRICT DEPARTMENT OF TRANSPORTATION HIGHWAY TRUST FUND FINANCIAL STATEMENT AUDIT FOR THE FISCAL YEAR ENDED SEPTEMBER 30, 2014	Highway Trust Fund	OIG	Closed	OIG audited financial statements of the HTF, which is administered by the DDOT as of and for the year ended September 30, 2014. These financial statements are the responsibility of the HTF's management and the OIG's responsibility is to express an opinion on these financial statements based on our audit	N/A	N/A
PTSA	April-15	n/a	Report of the APTA Peer Review Panel on the Streetcar Service Readiness	Streetcar program overview	APTA	Close	"There appear to be no critical issues in the project that would prevent it from beginning passenger or revenue service." 18 items were recommended to complete prior to entering revenue service.	Completed	DDOT has addressed all issues.
OD	January-16	DCA182014	STATUS REPORT ON IMPLEMENTATION OF DISTRICT OF COLUMBIA AUDITOR RECOMMENDATIONS	Contractor Selection & Quality Assurance	DC Auditor	Open	DDOT should develop clear and complete guidance for required responsibility reviews so that they will be consistently conducted and documented.	Open	DDOT is preparing a response to address DC Auditor recommendations.
OD	January-16	DCA182014	STATUS REPORT ON IMPLEMENTATION OF DISTRICT OF COLUMBIA AUDITOR RECOMMENDATIONS	Contractor Selection & Quality Assurance	DC Auditor	Open	DDOT management should further clarify their policies and procedures to indicate which deadline is to be used when calculating possible liquidated damages. In addition, the date which contract work is determined to be complete must be clearly communicated to all parties and documented.	Open	DDOT is preparing a response to address DC Auditor recommendations.
PTSA	January-16	FTA SMR	FTA State Management Review	State Management Review	DDOT	Open	DDOT made some clarifications in their procurement and grants management standard operating procedures to include new FTA grant requirements, which included: ensure all subrecipients provide a DUNS number, correct FFR reporting to FTA by OCFD, inclusion of consistent verification of procurements check with the FFATA and SAMS reporting systems, inclusion of consistent verification in procurements of vehicles that required it of TMV and Pre and Post Award audits. FTA also included the need for additional clarification regarding verification of Lobbying Certifications when required and lastly the need to further improve our practices regarding our vehicle maintenance oversight for 5310 vehicles. DDOT revised all its processes to date and provided revisions to FTA. DDOT is currently awaiting their comments.	Open	Currently pending FTA Review on DDOT response; DDOT provided a response to FTA regarding the findings of the 2015 agency State Management Plan. We are awaiting to hear from the regarding comments/confirmation of findings close out.

STREETSCAPE PROJECTS FY2016 and FY2017 [FEDERAL & LOCAL]

Project Name	Location	Budget	Status	On Schedule?	Anticipated Completion Date
Dedicate Bus Lanes on Georgia Ave., NW	Florida Ave to Barry Place	\$5M	Construction	Yes	2nd Qtr, 2016
Safety Improvements on 15th St., NW Intersection	15th St, NW intersections with V. St, and W. St.	\$4M	Construction	Yes	2nd Qtr, 2016
Streetscape of 7th St., NW	N St, NW to Florida Ave., NW	\$8M	Construction	Yes	1st Qtr, 2017
14th St., NW Streetscape	Thomas Circle to Florida Ave., NW	\$10 M	Design 90%	Yes	3rd Qtr, 2016
U Street, NW Phase II Reconstruction	14th St., NW west to Florida Ave. NW	\$10M	Design 90%	Yes	3rd Qtr, 2017
WARD 8 STREETSCAPES	MLK Jr. Avenue, SE from S Capitol Street to Milwaukee Place	\$6M	Final Design	Yes	2nd Qtr, 2017
Cleveland Park Streetscape and Drainage Improvement	Conn. Ave from Macomb to Quebec	\$2.5M	Design	Yes	1st Qtr, 2017
Kennedy Streetscape	Georgia to North Capitol Street	\$3.5M	Design	Delayed (Rebid)	2nd Qtr, 2016
17th Street	Potomac to Benning	\$9M	Construction	Delayed (DC Water/Gas)	2nd Qtr, 2018
Revitalization of Minnesota Ave, NE	Benning Rd to Sheriff Rd	\$700k	Final Design	Yes	2nd Qtr, 2017
NJ & NY Avenues Intersection Improvements	H st to N st	\$14M	Construction	Delayed (Cap. Crossing)	3rd Qtr, 2018

WORK TYPE	FUNDING SOURCE	Approximate Location	Ward
STREET PAVING	LOCAL	27TH ST NW and NORTHAMPTON ST NW	4
STREET PAVING	LOCAL	31ST ST NW and DANIEL LN NW	4
STREET PAVING	LOCAL	32ND ST NW and RITTENHOUSE ST NW	4
STREET PAVING	LOCAL	8TH ST NW and RANDOLPH ST NW	4
STREET PAVING	LOCAL	STEPHENSON LN NW and NEBRASKA AVE NW	4
STREET PAVING	LOCAL	WEST BEACH TER NW and DEAD END NW	4
STREET PAVING	LOCAL	21ST ST NE and H ST NE	5
STREET PAVING	LOCAL	SHEPHERD ST NE and 19TH ST NE	5
STREET PAVING	LOCAL	1ST ST SE and C ST SE	6
STREET PAVING	LOCAL	3RD ST SE and SOUTH CAROLINA AVE SE	6
STREET PAVING	LOCAL	31ST ST SE and GAINESVILLE ST (N) SE	7
STREET PAVING	LOCAL	31ST ST SE and TERRACE RD SE	7
STREET PAVING	LOCAL	31ST ST SE and ERIE ST SE	7
STREET PAVING	LOCAL	37TH ST SE and RIDGE RD SE	7
STREET PAVING	LOCAL	G ST SE and CHAPLIN ST SE	7
STREET PAVING	LOCAL	2ND ST SE and ORANGE ST SE	8
STREET PAVING	LOCAL	V ST SE and FENDALL ST SE	8
STREET PAVING	FEDERAL	KENYON ST NW and 13TH ST NW	1
STREET PAVING	FEDERAL	20TH ST NW and L ST NW	2
STREET PAVING	FEDERAL	20TH ST NW and M ST NW	2
STREET PAVING	FEDERAL	C ST NW and 3RD ST NW	2
STREET PAVING	FEDERAL	M ST NW and NEW HAMPSHIRE AVE NW	2
STREET PAVING	FEDERAL	M ST NW and 22ND ST NW	2
STREET PAVING	FEDERAL	WOODLEY RD NW and 34TH ST NW	3
STREET PAVING	FEDERAL	WOODLEY RD NW and 35TH ST NW	3
STREET PAVING	FEDERAL	WOODLEY RD NW and 36TH ST NW	3
STREET PAVING	FEDERAL	PINEY BRANCH RD NW and GEORGIA AVE NW	4
STREET PAVING	FEDERAL	QUEENS CHAPEL RD NE and 22ND ST NE	5
STREET PAVING	FEDERAL	QUEENS CHAPEL RD NE and CHANNING ST NE	5
STREET PAVING	FEDERAL	QUEENS CHAPEL RD NE and LAFAYETTE AVE NE	5
STREET PAVING	FEDERAL	QUEENS CHAPEL RD NE and DOUGLAS ST NE, PARK AVE NE	5
STREET PAVING	FEDERAL	C ST NE and 18TH ST NE	6
STREET PAVING	FEDERAL	SOUTHERN AVE SE and PENNSYLVANIA AVE SE	7
STREET PAVING	FEDERAL	13TH ST SE and RIDGE PL SE	8
STREET PAVING	FEDERAL	13TH ST SE and S ST SE	8
STREET PAVING	FEDERAL	13TH ST SE and T ST SE	8
STREET PAVING	FEDERAL	K ST NW and 9TH ST (N) NW	2
STREET PAVING	FEDERAL	K ST NW and 10TH ST NW	2
STREET PAVING	FEDERAL	MASSACHUSETTS AVE NW and BELMONT RD NW	2
STREET PAVING	FEDERAL	CONNECTICUT AVE NW and NEBRASKA AVE NW	3
STREET PAVING	FEDERAL	CONNECTICUT AVE NW and Chevy Chase PKWY	3
STREET PAVING	FEDERAL	CONNECTICUT AVE NW and Huntington St.	3
STREET PAVING	FEDERAL	CONNECTICUT AVE NW and Ingomar St.	3
STREET PAVING	FEDERAL	CONNECTICUT AVE NW and Jenifer St.	3

STREET PAVING	FEDERAL	CONNECTICUT AVE NW and Jocelyn St.	3
STREET PAVING	FEDERAL	CONNECTICUT AVE NW and Kanawha St.	3
STREET PAVING	FEDERAL	CONNECTICUT AVE NW and Military Rd.	3
STREET PAVING	FEDERAL	CONNECTICUT AVE NW and Legation St.	3
STREET PAVING	FEDERAL	CONNECTICUT AVE NW and Livingston St.	3
STREET PAVING	FEDERAL	CONNECTICUT AVE NW and Morrison St.	3
STREET PAVING	FEDERAL	CONNECTICUT AVE NW and McKingly St.	3
STREET PAVING	FEDERAL	CONNECTICUT AVE NW and Northhampton St.	3
STREET PAVING	FEDERAL	CONNECTICUT AVE NW and Oliver St.	3
STREET PAVING	FEDERAL	16TH ST NW and FORT STEVENS DR NW	4
STREET PAVING	FEDERAL	16TH ST NW and JOYCE RD NW, RITTENHOUSE ST NW	4
STREET PAVING	FEDERAL	16TH ST NW and SHERIDAN ST NW	4
STREET PAVING	FEDERAL	16TH ST NW and LUZON AVE NW, SOMERSET PL NW	4
STREET PAVING	FEDERAL	16TH ST NW and TUCKERMAN ST NW	4
STREET PAVING	FEDERAL	16TH ST NW and UNDERWOOD ST (S) NW	4
STREET PAVING	FEDERAL	16TH ST NW and UNDERWOOD ST (N) NW	4
STREET PAVING	FEDERAL	16TH ST NW and VAN BUREN ST (S) NW	4
STREET PAVING	FEDERAL	16TH ST NW and VAN BUREN ST (N) NW	4
STREET PAVING	FEDERAL	16TH ST NW and WHITTIER ST NW	4
STREET PAVING	FEDERAL	16TH ST NW and WHITTIER PL NW	4
STREET PAVING	FEDERAL	16TH ST NW and Aspen St.	4
STREET PAVING	FEDERAL	GEORGIA AVE NW and ELDER ST NW	4
STREET PAVING	FEDERAL	GEORGIA AVE NW and FERN ST NW	4
STREET PAVING	FEDERAL	GEORGIA AVE NW and FERN PL NW	4
STREET PAVING	FEDERAL	GEORGIA AVE NW and GERANIUM ST NW	4
STREET PAVING	FEDERAL	GEORGIA AVE NW and HEMLOCK ST NW	4
STREET PAVING	FEDERAL	GEORGIA AVE NW and SHEPHERD RD NW	4
STREET PAVING	FEDERAL	GEORGIA AVE NW and JUNIPER ST NW	4
STREET PAVING	FEDERAL	GEORGIA AVE NW and KALMIA RD NW	4
STREET PAVING	FEDERAL	GEORGIA AVE NW and ALASKA AVE NW	4
STREET PAVING	FEDERAL	GEORGIA AVE NW and ALASKA AVE NW	4
STREET PAVING	FEDERAL	NEW HAMPSHIRE AVE NE and NEW HAMPSHIRE AVE NW, NORTH CAPITOL ST BN	4
STREET PAVING	FEDERAL	NEW HAMPSHIRE AVE NE and LONGFELLOW ST NE	4
STREET PAVING	FEDERAL	NEW HAMPSHIRE AVE NE and BLAIR RD NE	4
STREET PAVING	FEDERAL	NEW HAMPSHIRE AVE NE and MADISON ST NE	4
STREET PAVING	FEDERAL	NORTH CAPITOL ST NW and MISSOURI AVE NW, RIGGS RD NE	4
STREET PAVING	FEDERAL	NORTH CAPITOL ST NW and JEFFERSON ST NE	4
STREET PAVING	FEDERAL	NORTH CAPITOL ST NW and KENNEDY ST NE, KENNEDY ST NW	4
STREET PAVING	FEDERAL	NORTH CAPITOL ST NW and MICHIGAN AVE NE, MICHIGAN AVE NW	5
STREET PAVING	FEDERAL	SOUTH DAKOTA AVE NE and VISTA ST NE	5
STREET PAVING	FEDERAL	SOUTH DAKOTA AVE NE and HAMLIN ST NE	5
STREET PAVING	FEDERAL	SOUTH DAKOTA AVE NE and CARLTON AVE NE	5

STREET PAVING	FEDERAL	SOUTH DAKOTA AVE NE and IRVING ST NE	5
STREET PAVING	FEDERAL	SOUTH DAKOTA AVE NE and 26TH ST NE, MYRTLE AVE NE	5
STREET PAVING	FEDERAL	H ST NW and H ST NE, NORTH CAPITOL ST BN	6
STREET PAVING	FEDERAL	H ST NW and 1ST ST NW	6
STREET PAVING	FEDERAL	H ST NW and NEW JERSEY AVE NW	6
STREET PAVING	FEDERAL	H ST NW and 2ND ST NW	6
STREET PAVING	FEDERAL	H ST NW and 3RD ST (N) NW	6
STREET PAVING	FEDERAL	WASHINGTON AVE SW and CANAL ST SE, SOUTH CAPITOL ST (N) BN	6
STREET PAVING	FEDERAL	MASSACHUSETTS AVE NW and WATERSIDE DR NW	2/3
STREET PAVING	FEDERAL	NORTH CAPITOL ST NW and BUCHANAN ST NE	4/5
STREET PAVING	FEDERAL	NORTH CAPITOL ST NW and CRITTENDEN ST NE	4/5
STREET PAVING	FEDERAL	NORTH CAPITOL ST NW and ROCK CREEK CHURCH RD (N) NE	4/5
STREET PAVING	FEDERAL	NORTH CAPITOL ST NW and FARRAGUT PL NW	4/5
STREET PAVING	FEDERAL	NORTH CAPITOL ST NW and GALLATIN ST NE, GALLATIN ST NW	4/5
STREET PAVING	FEDERAL	NORTH CAPITOL ST NW and HAMILTON ST NE, HAMILTON ST NW	4/5
STREET PAVING	FEDERAL	NORTH CAPITOL ST NW and INGRAHAM ST NW	4/5
SIDEWALK REPAIR	LOCAL	MANOR PLACE NW and Park Place	1
SIDEWALK REPAIR	LOCAL	GEORGIA AVENUE NW and W Street	1
SIDEWALK REPAIR	LOCAL	PRINCETON PLACE NW and Park Place	1
SIDEWALK REPAIR	LOCAL	PRINCETON PLACE NW and Park Place	1
SIDEWALK REPAIR	LOCAL	W STREET NW and 15th Street	1
SIDEWALK REPAIR	LOCAL	17TH STREET NW and Euclid Street	1
SIDEWALK REPAIR	LOCAL	17TH STREET NW and Euclid Street	1
SIDEWALK REPAIR	LOCAL	NEW HAMPSHIRE AVENUE NW and V St	1
SIDEWALK REPAIR	LOCAL	NEW HAMPSHIRE AVENUE NW and V St	1
SIDEWALK REPAIR	LOCAL	COLUMBIA RD & BELMONT STREET NW and	1
SIDEWALK REPAIR	LOCAL	COLUMBIA ROAD NW and 18th Street	1
CURB & GUTTER REPAIR	LOCAL	KALORAMA ROAD NW and Connecticut Ave	1
CURB & GUTTER REPAIR	LOCAL	KALORAMA ROAD NW and 18th St	1
SIDEWALK REPAIR	LOCAL	CHAMPLAIN STREET NW and Columbia Road	1
SIDEWALK REPAIR	LOCAL	VIRGINIA AVENUE NW and 20th Street	2
SIDEWALK REPAIR	LOCAL	32ND STREET NW and Reservoir Road	2
SIDEWALK REPAIR	LOCAL	4TH STREET NW and F Street	2
SIDEWALK REPAIR	LOCAL	4TH STREET NW and F Street	2
SIDEWALK REPAIR	LOCAL	14TH STREET NW and N Street	2
SIDEWALK REPAIR	LOCAL	G STREET NW and 5th Street	2
CURB & GUTTER REPAIR	LOCAL	PENNSYLVANIA AVENUE NW AND 14TH STREET NW and	2
SIDEWALK REPAIR	LOCAL	7TH STREET NW and T Street	2
SIDEWALK REPAIR	LOCAL	FULTON STREET NW and 49th Street	3
CURB & GUTTER REPAIR	LOCAL	LOWELL STREET NW and Lowell Lane	3
SIDEWALK REPAIR	LOCAL	CLEVELAND AVENUE NW and 34th Street	3

SIDEWALK REPAIR	LOCAL	CLEVELAND AVENUE NW and 29TH ST NW	3
SIDEWALK REPAIR	LOCAL	MACOMB STREET NW and Connecticut Ave	3
SIDEWALK REPAIR	LOCAL	MASSACHUSETTS AVENUE NW and Garfield Street	3
CURB & GUTTER REPAIR	LOCAL	MASSACHUSETTS AVENUE NW and Observatory Lane	3
SIDEWALK REPAIR	LOCAL	MASSACHUSETTS AVENUE NW and Observatory Lane	3
SIDEWALK REPAIR	LOCAL	MILLWOOD LANE NW and Glenbrook Road	3
CURB & GUTTER REPAIR	LOCAL	MURDOCK MILL ROAD NW and 43rd Place	3
SIDEWALK REPAIR	LOCAL	42ND ST NW and Van Ness Street	3
SIDEWALK REPAIR	LOCAL	21ST STREET and VIRGINIA AVE NW	3
CURB & GUTTER REPAIR	LOCAL	GARFIELD STREET NW AND BELLEVUE TERRACE NW and	3
SIDEWALK REPAIR	LOCAL	CONNECTICUT AVE NW and Devonshire Place	3
SIDEWALK REPAIR	LOCAL	CONNECTICUT AVE NW and Appleton Street	3
SIDEWALK REPAIR	LOCAL	CONNECTICUT AVE NW and Devonshire Place	3
SIDEWALK REPAIR	LOCAL	27TH STREET NW and Nebraska Ave	4
SIDEWALK REPAIR	LOCAL	27TH STREET NW and Nebraska Ave	4
SIDEWALK REPAIR	LOCAL	30TH STREET NW and Kanawha Street	4
CURB & GUTTER REPAIR	LOCAL	32ND STREET NW and Stephenson Place	4
SIDEWALK REPAIR	LOCAL	5TH STREET NW and Roxboro Place	4
SIDEWALK REPAIR	LOCAL	8TH STREET NW and Shepherd Street	4
SIDEWALK REPAIR	LOCAL	CEDAR STREET NW and Blair Road	4
CURB & GUTTER REPAIR	LOCAL	STEPHENSON LANE NW and 29th Street	4
SIDEWALK REPAIR	LOCAL	SUDBURY ROAD NW and Sudbury Place	4
SIDEWALK REPAIR	LOCAL	WEBSTER STREET NW and Georgia Ave	4
SIDEWALK REPAIR	LOCAL	WEST BEACH TERRACE NW and Dead End	4
SIDEWALK REPAIR	LOCAL	EASTERN AVE NE and TUCKERMAN ST NE	4
SIDEWALK REPAIR	LOCAL	SHEPHERD STREET NE and 19th Street	5
SIDEWALK REPAIR	LOCAL	30TH STREET NE and Franklin Street	5
SIDEWALK REPAIR	LOCAL	CENTRAL AVENUE NE and 30th Street	5
SIDEWALK REPAIR	LOCAL	CHANNING STREET NE and Saratoga Ave	5
SIDEWALK REPAIR	LOCAL	SOUTH DAKOTA AVENUE NE and Rhode Island Ave	5
CURB & GUTTER REPAIR	LOCAL	21ST STREET NE and I Street	5
SIDEWALK REPAIR	LOCAL	DELAFIELD PLACE NE and Sargent Road	5
SIDEWALK REPAIR	LOCAL	3RD STREET NE AND EVARTS STREET NE and	5
SIDEWALK REPAIR	LOCAL	BENNING ROAD NE and 18th Street	5
SIDEWALK REPAIR	LOCAL	KENNEDY STREET NE and Chillum Place	5
SIDEWALK REPAIR	LOCAL	ALLISON ST NE and 6TH PL NE	5
SIDEWALK REPAIR	LOCAL	SOUTH DAKOTA AVE NE and 26TH ST NE, MYRTLE AVE NE	5
SIDEWALK REPAIR	LOCAL	1ST STREET SE and C Street	6
SIDEWALK REPAIR	LOCAL	2ND STREET NE and D Street	6
SIDEWALK REPAIR	LOCAL	6TH STREET NW and Q Street	6
SIDEWALK REPAIR	LOCAL	CONSTITUTION AVE NE and Massachusetts Ave	6
SIDEWALK REPAIR	LOCAL	CST SE and 16th Street	6
CURB & GUTTER REPAIR	LOCAL	37TH STREET SE and Ridge Road	7

SIDEWALK REPAIR	LOCAL	47TH STREET NE and Dix Street	7
CURB & GUTTER REPAIR	LOCAL	GAY STREET NE and Division Ave	7
SIDEWALK REPAIR	LOCAL	PENNSYLVANIA AVENUE SE AND 9TH STREET SE WASHINGTON and	7
SIDEWALK REPAIR	LOCAL	LYNDALE PLACE SE and MINNESOTA AVE SE	7
SIDEWALK REPAIR	LOCAL	V PLACE SE and 31ST STREET	7
SIDEWALK REPAIR	LOCAL	V PLACE SE and 31ST STREET	7
SIDEWALK REPAIR	LOCAL	31ST STREET SE and Erie Street	7
SIDEWALK REPAIR	LOCAL	G STREET SE and Chaplin Street	7
SIDEWALK REPAIR	LOCAL	L'ENFANT SQAURE SE and MINNESOTA AVE SE	7
CURB & GUTTER REPAIR	LOCAL	MASSACHUSETTS AVENUE SE and Bayley Place	7
SIDEWALK REPAIR	LOCAL	Potomac Ave, S.W. and	7
CURB & GUTTER REPAIR	LOCAL	MASSACHUSETTS AVENUE SE AND 31ST STREET SE and	7
CURB & GUTTER REPAIR	FEDERAL	COLUMBIA ROAD NW and 18th Street	1
CURB & GUTTER REPAIR	FEDERAL	New Hampshire Ave. & Rock Creek Church Rd NW and	1
SIDEWALK REPAIR	FEDERAL	18th St NW and H St	2
SIDEWALK REPAIR	FEDERAL	14th Street and Independence Ave SW and	2
SIDEWALK REPAIR	FEDERAL	16th Street and M Street NW and	2
SIDEWALK REPAIR	FEDERAL	14TH STREET NW and N Street	2
SIDEWALK REPAIR	FEDERAL	15TH STREET NW and Caroline St. NW and	2
SIDEWALK REPAIR	FEDERAL	13TH ST & I ST NW and	2
CURB & GUTTER REPAIR	FEDERAL	18th Street NW and H St.	2
CURB & GUTTER REPAIR	FEDERAL	18th Street and Massachussetts Ave NW and	2
CURB & GUTTER REPAIR	FEDERAL	18th Street and Constitution Ave NW and	2
CURB & GUTTER REPAIR	FEDERAL	19th Street and N Street NW and	2
CURB & GUTTER REPAIR	FEDERAL	K St NW and 25th St.	2
SIDEWALK REPAIR	FEDERAL	21st and E St NW and	2
SIDEWALK REPAIR	FEDERAL	GRANT CIRCLE NW and	4
SIDEWALK REPAIR	FEDERAL	CEDAR STREET NW and Blair Road	4
SIDEWALK REPAIR	FEDERAL	M St SE and 1st St	6
SIDEWALK REPAIR	FEDERAL	2nd St. & Q St SW and	6
SIDEWALK REPAIR	FEDERAL	2ND STREET NE and D Street	6
SIDEWALK REPAIR	FEDERAL	Canal St and First St SW and	6
SIDEWALK REPAIR	FEDERAL	L'ENFANT SQAURE SE and MINNESOTA AVE SE	7
SIDEWALK REPAIR	FEDERAL	Potomac Ave, S.W. and SOUTH CAPITOL ST	7
SIDEWALK REPAIR	FEDERAL	MASSACHUSETTS AVENUE SE and Bayley Place	7
SIDEWALK REPAIR	FEDERAL	46TH STREET SE and BENNING RD SE	7
SIDEWALK REPAIR	FEDERAL	Benning Rd SE and E St and	7
SIDEWALK REPAIR	FEDERAL	Pennsylvania Ave and Anacostia FRWY SE (below Bridge) and	7
SIDEWALK REPAIR	FEDERAL	2ND ST & OAKWOOD St SE and	8
SIDEWALK REPAIR	FEDERAL	25TH STREET SE and ALABAMA AVE	8
SIDEWALK REPAIR	FEDERAL	16TH ST SE AND R ST. SE and	8
SIDEWALK REPAIR, CURB RAMP, BUS STOP	FEDERAL	Southern Ave SE and So. Capitol St.	8
ALLEY REHAB	LOCAL	1500 and Monroe St.	1

ALLEY REHAB	LOCAL	1000 and 1000 block of Quebec Place, NW (South Side)	1
ALLEY REHAB	LOCAL	1518 and KSt.	2
ALLEY REHAB	LOCAL	3111 and Sherman Ave.	2
ALLEY REHAB	LOCAL	3810 and Klinge Pl.	3
ALLEY REHAB	LOCAL	3300 and Tennyson Street & Stuyvesant Street	4
ALLEY REHAB	LOCAL	3300 and 3300Runnymede & Stephenson Place, NW	4
ALLEY REHAB	LOCAL	600 and 600 block of Upshur Street, NW (South Side)	4
ALLEY REHAB	LOCAL	200 and 200 block of Upshur Street, NW (South Side)	4
ALLEY REHAB	LOCAL	4700 and 4700 block of 14th Street, NW (West Side)	4
ALLEY REHAB	LOCAL	4600 and 4600 block of Blagden Avenue, NW (South Side)	4
ALLEY REHAB	LOCAL	616 and H St.	6
ALLEY REHAB	LOCAL	1323 and Linden Ct.	6
ALLEY REHAB	LOCAL	335 and Maryland Ave.	6
ALLEY REHAB	LOCAL	310 and 01st St.	6
ALLEY REHAB	LOCAL	926 and 8th Street	6
ALLEY REHAB	LOCAL	3826 and 3826 V St SE	7
ALLEY REHAB	LOCAL	3839 and 01st St.	8
ALLEY REHAB	LOCAL	2432 and Irving St.	8

FY 15 Service Request Counts with Average Days

Service Request Type	Number of Records	Ave. Days to Inspect	Ave. Days to Close
Alley Repair	1,103	32	108
Alleylight Repair	3,026	16	9
Bicycle Issues	857	74	74
Bus/Rail Issues	127	11	11
Curb and Gutter Repair	368	39	61
Marking Installation	191	71	82
Marking Maintenance	346	38	44
Marking Modification	69	100	121
Marking Removal	14	130	131
Parking Meter Repair	78,877	2	81
Pothole	16,732	13	14
Resident Parking Permit	188	87	87
Safe Routes to School	41	16	16
Sidewalk Repair	1,733	36	75
Sign Missing Investigation	565	26	34
Sign New Investigation	1,303	91	95
Sign Removal investigation	355	41	46
Sign Replacement	2,223	11	20
Signs Conflicting	472	77	80
Street Repair	1,793	40	77
Streetlight Repair Investigation	9,567	28	13
Traffic Calming	450	96	99
Traffic Signal Maintenance	1,991	52	52
Tree Inspection	4,499	1	2
Tree Planting	1,435	14	53
Tree Pruning	3,496	25	71
Tree Removal	1,788	13	37
Utility Repair Investigation	983	78	84
Grand Total	134,592	20	60

Service Request Type	Ave. Days to Inspect	Ave. Days to Close
	FY 2015 vs FY 16	FY 2015 vs FY 16
	Q1	Q1
Alley Repair	Increase	Decrease
Alleylight Repair	Increase	Decrease
Bicycle Issues	Decrease	Decrease
Bus/Rail Issues	Decrease	Decrease
Curb and Gutter Repair	Increase	Decrease
Marking Installation	Decrease	Decrease
Marking Maintenance	Decrease	Decrease
Marking Modification	Decrease	Decrease
Marking Removal	Decrease	Decrease
Parking Meter Repair	Increase	Even
Pothole	Decrease	Decrease
Resident Parking Permit	Decrease	Decrease
Safe Routes to School	Decrease	Decrease
Sidewalk Repair	Increase	Decrease
Sign Missing Investigation	Decrease	Decrease
Sign New Investigation	Decrease	Decrease
Sign Removal investigation	Decrease	Decrease
Sign Replacement	Decrease	Decrease
Signs Conflicting	Decrease	Decrease
Street Repair	Increase	Decrease
Streetlight Repair Investigation	Increase	Decrease
Traffic Calming	Decrease	Decrease
Traffic Signal Maintenance	Decrease	Decrease
Tree Inspection	Decrease	Decrease
Tree Planting	Decrease	Decrease
Tree Pruning	Decrease	Decrease
Tree Removal	Decrease	Decrease
Utility Repair Investigation	Decrease	Decrease
Grand Total	Decrease	Decrease



District Department of Transportation

High Crash Intersection Site Visits

Summary and Next Steps

January 2016





High Crash Intersection Site Visits

Summary and Next Steps

Table of Contents

- 1.0 Introduction..... 5**
- 2.0 First Street and Massachusetts Avenue NE 7**
 - 2.1. Crash Data 7
 - 2.2. Recent and Planned Projects 9
 - 2.3. Site Visit Observations 9
 - 2.4. Next Steps 11
- 3.0 Bladensburg Road and New York Avenue NE 12**
 - 3.1. Crash Data 12
 - 3.2. Recent and Planned Projects 14
 - 3.3. Site Visit Observations 14
 - 3.4. Next steps 17
- 4.0 14th Street and U Street NW 18**
 - 4.1. Crash Data 18
 - 4.2. Recent and Planned Projects 19
 - 4.3. Site Visit Observations 21
 - 4.4. Next steps 23
- 5.0 Minnesota Avenue and Benning Road NE 25**
 - 5.1. Crash Data 25
 - 5.2. Recent and Planned Projects 26
 - 5.3. Site Visit Observations 28
 - 5.4. Next steps 29



6.0 M Street and Wisconsin Avenue NW 32

6.1. Crash Data 32

6.2. Recent and Planned Projects 33

6.3. Site Visit Observations 34

6.4. Next steps 35

7.0 Conclusion 38

8.0 Appendix A: Large Format Location Issue Maps 39

List of Tables

Table 1: Site Visit Locations and Dates 5

Table 2: First Street and Massachusetts Avenue NE Next Steps 12

Table 3: Bladensburg Road and New York Avenue NE Next Steps 17

Table 4: 14th Street and U Street NW Next Steps 24

Table 5: Benning Road and Minnesota Avenue NE Next Steps 30

Table 6: M Street and Wisconsin Avenue NW Next Steps 36

List of Figures

Figure 1: First Street and Massachusetts Avenue NE Crash Data 8

Figure 2: First Street and Massachusetts Avenue NE Site Visit Observations 9

Figure 3: Bladensburg Road and New York Avenue NE Crash Data 13

Figure 4: New York and Bladensburg Road NE Site Visit Observations 14

Figure 5: A police officer is regularly posted at the intersection of T Street and Bladensburg NE to facilitate pedestrian crossings and is visible in Google Street View. 15

Figure 6: 14th Street and U Street NW Crash Data 19

Figure 7: 14th Street NW Streetscape Project Boundaries 20

Figure 8: 14th Street NW and U Street Intersection – Signage and Pavement Marking Plan 21

Figure 9: 14th and U Street NW Site Visit Observations 22

High Crash Intersection Site Visits



Figure 10: Minnesota Avenue and Benning Road NE Crash Data..... 26

Figure 11: Minnesota Avenue and Benning Road Intersection – Signage and Pavement Markings..... 27

Figure 12: Minnesota Avenue and Benning Road NE Site Visit Observations 28

Figure 13: Mock-up of Potential Interim "Pedestrian Refuge" on West Side Crossing of Benning Road... 31

Figure 14: M Street and Wisconsin Avenue NW Crash Data 33

Figure 15: M Street and Wisconsin Avenue NW Site Visit Observations..... 34

Figure 16: Conceptual Layout for Curb Extensions..... 37



1.0 Introduction

Councilmember Mary Cheh coordinated site visits to five “high crash” intersections with the District Department of Transportation during an 8-day period from August 27, 2015 to September 5, 2015. The site visits engaged members of the local Advisory Neighborhood Commissions (ANCs), Business Improvement Districts (BIDs) and other business groups, members of the Bicycle and Pedestrian Advisory Councils (BAC and PAC), the Washington Area Bicyclist Association (WABA), All Walks DC and other concerned stakeholders. The following table outlines the locations and dates of each of the conducted site visits.

Table 1: Site Visit Locations and Dates

Site Visit Location	Date
First Street and Massachusetts Avenue NE	August 27, 2015
14 th Street and U Street NW	September 1, 2015
Minnesota Avenue and Benning Road NE	September 2, 2015
New York Avenue and Bladensburg Road NE	September 3, 2015
Wisconsin Avenue and M Street NW	September 4, 2015

Collectively, these five intersections were the locations of three fatalities and 12 disabling injuries in the last 3½ years. With the Vision Zero Initiative, DDOT and the District as a whole seeks to eliminate traffic-based fatalities and serious injuries within 10 years. To accomplish this requires a proactive approach to analyzing and addressing behaviors and physical conditions that contribute to traffic deaths. DDOT analyzed historical crash data to inform the discussion and formulation of action steps at each of the intersections. This process reinforced the incomplete nature of crash data. For example, a contributing factor is not specified in nearly 80 percent of the crashes at the five intersections visited. Through our efforts to enhance data collection and reporting as part of the Vision Zero initiative, we will work collaboratively with our enforcement partners to ensure that we have comprehensive data to inform our safety priorities and improvements.

The site visits were conducted in an open and collaborative manner, with participants identifying and discussing issues and potential solutions. Each site visit summary includes:

1. Crash analysis and data
2. Recent and planned projects for the location
3. A discussion of site visit observations
4. A summary of next steps and action items

High Crash Intersection Site Visits



DDOT intends to use these site visit summaries as a guide to inform and prioritize short-term, interim, and longer-term infrastructure improvements to promote increased safety at these five locations. DDOT values the collaborative nature of the site visits and intends to utilize this method of targeted stakeholder engagement on safety issues moving forward. In early spring 2016, DDOT plans to organize another series of five intersection site visits in early spring of 2016. The following sections present the site visit summaries at each of the five high crash locations that were a part of this initiative.

2.0 First Street and Massachusetts Avenue NE

The intersection of First Street and Massachusetts Avenue NE is adjacent to Union Station and functionally serves as the confluence of First Street, Massachusetts Avenue, the vehicular exit from Columbus Plaza, and E Street NE. This is a complex intersection with multiple traffic signal phases.

The August 27, 2015 site visit included staff from Councilmembers Cheh, Allen, and Grosso's offices, as well as representatives from ANC 6C, bicycle and pedestrian advocates, and members of the Bicycle and Pedestrian Advisory Councils.

2.1. Crash Data

From January 1, 2012 through August 1, 2015, there were more than 200 crashes at this intersection. More than half of these crashes were sideswipes, which tend to occur when drivers quickly change lanes. The severity of these crashes was fairly low, with one disabling injury, four non-disabling injuries, and one crash in which speed was a contributing factor. Bicycle and pedestrian involvement was also low, representing three and five crashes respectively. The rate of taxi involved accidents at this location was extremely high at 30 percent, but, accounted for, in part, by the adjacency to Union Station. Figure 1 provides the summary report of crashes at this location.



DC Department of Transportation - Traffic Accident Reporting and Analysis System

Accident Summary Report (R-7)

Intersection: 1ST ST and COLUMBUS CIR (WEST), NE

Time Period Covered: From 01/01/2012 To 08/01/2015

Prepared By: admin TARAS

Prepared Date: 9/2/2015

		Collision Type	#ACC	%	Collision Type	#ACC	%
Total Number of Accident:	207	Right Angle:	5	2.4%	Fixed Object:	3	1.4%
Total Number of Fatalities:	0	Left Turn:	3	1.4%	Ran Off Road:	0	0.0%
Total Number of Injuries:	19	Right Turn:	3	1.4%	Ped. Involved:	5	2.4%
Total Number of Disabling Injuries:	1	Rear End:	23	11.1%	Backing:	5	2.4%
Total Number of NonDisabling Injuries:	4	Side Swiped:	122	58.9%	Non Collision:	0	0.0%
Total Number of Pedestrians Involved:	5	Head On:	0	0.0%	Under/Over Ride:	1	0.5%
Total Number of Bicycles Involved:	3	Parked:	14	6.8%	Unspecified:	23	11.1%
Total Number of Motorcycles Involved:	0						

Time of Day	#ACC	%	Day of week	#ACC	%
07:30 ~ 09:30:	18	8.7%	Sunday:	14	6.8%
09:30 ~ 11:30:	27	13.0%	Monday:	34	16.4%
11:30 ~ 13:30:	35	16.9%	Tuesday:	42	20.3%
13:30 ~ 16:00:	50	24.2%	Wednesday:	25	12.1%
16:00 ~ 18:30:	34	16.4%	Thursday:	27	13.0%
18:30 ~ 07:30:	43	20.8%	Friday:	42	20.3%
Unspecified:	0	0.0%	Saturday:	23	11.1%

Weather Condition	#ACC	%	Surface Condition	#ACC	%
Clear:	176	85.0%	Dry:	180	87.0%
Rain:	15	7.2%	Wet:	21	10.1%
Snow:	2	1.0%	Snow/Ice:	1	0.5%
Sleet/Hail:	0	0.0%	Slush:	0	0.0%
Fog/Mist:	3	1.4%	Water/Sand:	0	0.0%
Crosswind/Blowing Sand:	2	1.0%	Repairing:	1	0.5%
Unspecified:	9	4.3%	Unspecified:	4	1.9%

Type of Vehicle	#VEH	%	Accident Severity Type	#ACC	%
Passenger Car:	172	42.4%	Fatal Collision:	0	0.0%
Bus:	61	15.0%	Injury Collision:	17	8.2%
Truck:	16	3.9%	PDO Collision:	190	91.8%
Taxi:	121	29.8%			
Minivan:	0	0.0%	Light Condition	#ACC	%
Police/Emergency Vehicle:	0	0.0%	Daylight:	156	75.4%
Motorcycle/Moped:	0	0.0%	Dawn/Dusk:	4	1.9%
Bicycle:	3	0.7%	Dark(Lighted):	36	17.4%
Fixed Object:	0	0.0%	Dark(Not Lighted):	2	1.0%
Unspecified:	33	8.1%	Dark(Unknown Lighting):	0	0.0%
			Unspecified:	9	4.3%

Contributing Factor	#VEH	%	Pedestrian Actions	#ACC	%
Driver: Speed:	1	0.2%	In Crosswalk with Signal:	1	20.0%
Driver: Alcohol/Drug:	1	0.2%	In Crosswalk against Signal:	0	0.0%
Driver: Electronic Device:	0	0.0%	In Crosswalk no Signal:	1	20.0%
Driver: Others:	68	16.7%	In Unmarked Crosswalk:	0	0.0%
Vehicle:	0	0.0%	Not in Crosswalk:	0	0.0%
Roadway:	2	0.5%	From Between Parked Cars:	0	0.0%
Unspecified:	334	82.3%	Unspecified:	3	60.0%

29 Records are not approved as of 9/2/2015 4:35:48 PM

Figure 1: First Street and Massachusetts Avenue NE Crash Data

High Crash Intersection Site Visits

2.2. Recent and Planned Projects

DDOT has recently completed several projects in this area, including: the full reconstruction of Columbus Plaza (2013), signal optimization as part of the Downtown area optimization (2015), and the completion of the Metropolitan Branch Trail extension on First Street NE (2015). DDOT has also worked with the Union Station Redevelopment Corporation over the past year to improve the operations of Columbus Plaza and installed some updated signage in Winter 2015. Additionally, in 2015, the Architect of the Capitol repaved E Street between Massachusetts Avenue and North Capitol and added bike lanes in coordination with DDOT.

2.3. Site Visit Observations

Participants identified issues related to all modes. Some may only require minor fixes, while others could require more substantial capital improvements. Many require further investigation and evaluation by DDOT. The timeline for next steps is included in the next section.

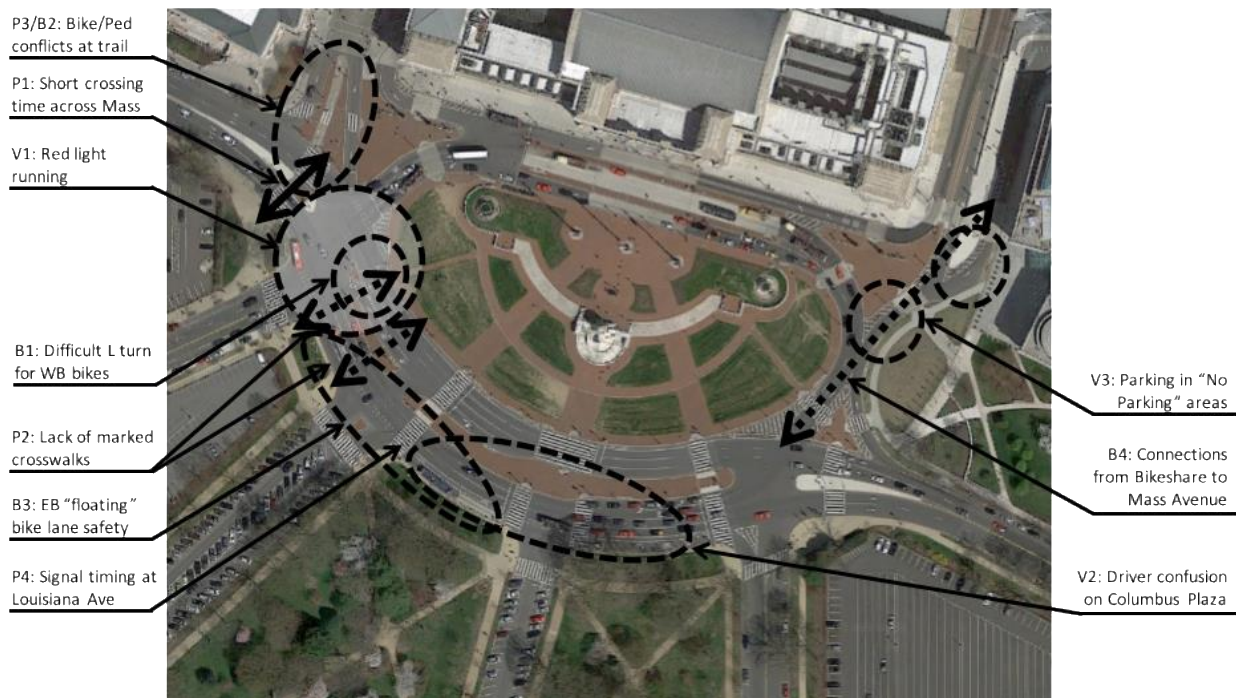

Figure 2: First Street and Massachusetts Avenue NE Site Visit Observations

Pedestrian Issues:

- P1. There is a short time for pedestrians to cross Massachusetts Ave NE. There is currently 10 seconds of “walk” time and 7 seconds of “don’t walk” time during AM peak. The multiple signal

High Crash Intersection Site Visits

phases in the intersection creates a challenge in allocating time for each. Participants observed a high number of pedestrians violating the signal and crossing during the “don’t walk” phase.

- P2. There is a lack of marked crossings of Massachusetts from E Street NE and Louisiana Avenue NE. There are currently no marked pedestrian crossings between the southeast side of Louisiana Avenue and the First Street crossing. This forces pedestrians to deviate from desire lines.
- P3. Where First Street connects to the plaza, the “trail” portion of the sidewalk and crosswalk are not clearly defined, so pedestrians walk in the trail. The pedestrian crossing at the top of First Street near the Bikestation is not clearly defined and pedestrians could be stranded in the median.
- P4. At Louisiana Avenue and Massachusetts Avenue, there is a lagging pedestrian phase for pedestrians crossing Massachusetts Avenue. Pedestrians are held when northbound cars on Louisiana Avenue receive a green light for the right turn. Next, the pedestrians get the walk signal but vehicles continue to get a green and proceed across the crosswalk.

Bicycle Issues:

- B1. People biking westbound on Massachusetts Avenue have a difficult time making the left turn onto E Street NE. E Street NE/NW offers a connected bike lane all the way to 13th Street NW and is a popular route. This maneuver currently requires crossing three lanes of vehicular traffic into the turn pocket.
- B2. People biking southbound on First Street NE have difficulty navigating the trail connection in the westbound Massachusetts direction. There is also some driver confusion with signals on First Street which leads to some conflicts with bicyclists following the bicycle signal.
- B3. People biking eastbound on Massachusetts have a pocket lane between the right turn lane and the through lane. Stakeholders reported seeing the right turn lane regularly used to bypass queues in an unsafe manner.
- B4. There is not an easy/designated way to bike from the Bikeshare station on 2nd Street to Massachusetts Avenue so riders go through Columbus Plaza, which creates challenges for all users.

Vehicular Issues:

- V1. During the site visit, the participants observed a number of instances of vehicles running red lights and blocking intersections, which significantly impacted overall traffic operations and posed safety challenges for users of all modes.

High Crash Intersection Site Visits

V2. Participants mentioned a general level of confusion for drivers, which could be a cause of the predominance of sideswipes noted in the crash history. Many drivers are trying to access Union Station, which can be confusing for those who do not regularly access the station.

V3. There are a number of areas marked off as no-parking with hatching but that nonetheless see people regularly parking. Parking is often close to crosswalks, which reduces visibility of people crossing.

2.4. Next Steps

The following table identifies the next step for each issue and the associated timeline. Wherever possible, both design/evaluation and implementation timelines are noted, but further exploration for some issues may find potential solutions infeasible.

Issue	Next step	Timeline
Pedestrian Issues		
P1. Short crossing time for pedestrians across Mass Ave NE.	Evaluate signal timing to see if more walk time can be given across Massachusetts.	Evaluation: February 2016 Implementation: March 2016
P2. Lack of marked crosswalks across Massachusetts Avenue.	Conduct investigation into crosswalk needs and potential issues, including ADA access and catch basins.	Evaluation: January 2016 Implementation: TBD
P3. Pedestrian/Bike conflicts from 1 st Street/MBT to Mass.	Identify marking changes, such as green paint or clearer delineation.	Design: February 2016 Implementation: May 2016
P4. Louisiana Avenue crossing of Mass.	Evaluate signal phasing to reduce conflicts with pedestrians.	Evaluation February 2016 Implementation: March 2016
Bicycle Issues		
B1. Difficulty of WB bikes on Mass.	Explore adding “two-stage” bike turn with bike box in front of vehicles exiting Columbus Plaza.	Design: February 2016 Implementation: May 2016
B2. Pedestrian/Bike conflicts from 1 st Street/MBT to Mass.	Identify marking changes, such as green paint or clearer delineation. Evaluate signal operations and potentially identify signage changes.	Design: February 2016 Implementation: May 2016
B3. EB Mass biking conditions.	Explore strategies, including: addition of green paint to the pocket lane, improved channelization, or removal of the right turn lane.	Design: February 2016 Implementation: May 2016
B4. Bike connection from Bikeshare station on 2 nd Street to Mass Ave.	Identify potential new or improved facilities.	Design: February 2016

High Crash Intersection Site Visits

Issue	Next step	Timeline
Vehicular Issues		
V1. Red light running	Explore automated red light enforcement with MPD.	Evaluation: March 2016 Implementation: TBD
V2. Driver confusion on Columbus Plaza	Work with USRC and Amtrak to explore adding additional lane markings on pavement directing drivers in advance of Columbus Plaza entry and/or signage upgrades.	Design: March 2016 Implementation: May 2016
V3. Parking in no-parking areas.	Explore addition of flex posts or other barriers to keep drivers from parking in these areas.	Design: March 2016 Implementation: May 2016

Table 2: First Street and Massachusetts Avenue NE Next Steps

3.0 Bladensburg Road and New York Avenue NE

Bladensburg Road and New York Avenue NE is one of the busiest intersections in the District, with around 100,000 vehicles each day, approximately 75,000 on New York Avenue and 25,000 on Bladensburg Road. In addition to the overall volumes, there are heavy turn volumes, which create challenges for pedestrians.

The September 3, 2015 site visit included staff from Councilmembers Cheh’s office, representatives from ANC 5C, MPD staff, bicycle and pedestrian advocates, and members of the Bicycle and Pedestrian Advisory Councils.

3.1. Crash Data

The crash data reflects the high vehicular volumes and higher speeds at this intersection when compared with the other intersections visited. The number of alcohol-related crashes was high as were the percent of the crashes involved trucks, which reflects the freight volume at this location. Nearly one third of the crashes were rear end, which is indicative of locations with high congestion and/or high speeds.

Not reflected in the crash data summary is the high number of hit and run crashes at this location, which MPD has noted. During the data period, there was one fatality and four disabling injuries at this location, along with a number of other injuries. Thirteen pedestrians and five bicyclists were involved in crashes at this intersection. Figure 3 provides the summary report of crashes at this location.

High Crash Intersection Site Visits



DC Department of Transportation - Traffic Accident Reporting and Analysis System

Accident Summary Report (R-7)**Intersection:** NEW YORK AVE and BLADENSBURG RD, NE**Time Period Covered:** From 01/01/2012 To 08/01/2015**Prepared By:** admin TARAS**Prepared Date:** 9/2/2015

		Collision Type	#ACC	%	Collision Type	#ACC	%
Total Number of Accident:	362	Right Angle:	22	6.1%	Fixed Object:	15	4.1%
Total Number of Fatalities:	1	Left Turn:	25	6.9%	Ran Off Road:	5	1.4%
Total Number of Injuries:	123	Right Turn:	21	5.8%	Ped. Involved:	9	2.5%
Total Number of Disabling Injuries:	4	Rear End:	117	32.3%	Backing:	20	5.5%
Total Number of NonDisabling Injuries:	22	Side Swiped:	89	24.6%	Non Collision:	3	0.8%
Total Number of Pedestrians Involved:	13	Head On:	7	1.9%	Under/Over Ride:	0	0.0%
Total Number of Bicycles Involved:	5	Parked:	4	1.1%	Unspecified:	25	6.9%
Total Number of Motorcycles Involved:	10						

Time of Day	#ACC	%	Day of week	#ACC	%
07:30 ~ 09:30:	43	11.9%	Sunday:	62	17.1%
09:30 ~ 11:30:	27	7.5%	Monday:	40	11.0%
11:30 ~ 13:30:	30	8.3%	Tuesday:	37	10.2%
13:30 ~ 16:00:	42	11.6%	Wednesday:	50	13.8%
16:00 ~ 18:30:	56	15.5%	Thursday:	49	13.5%
18:30 ~ 07:30:	164	45.3%	Friday:	67	18.5%
Unspecified:	0	0.0%	Saturday:	57	15.7%

Weather Condition	#ACC	%	Surface Condition	#ACC	%
Clear:	288	79.6%	Dry:	295	81.5%
Rain:	41	11.3%	Wet:	53	14.6%
Snow:	1	0.3%	Snow/Ice:	0	0.0%
Sleet/Hail:	1	0.3%	Slush:	0	0.0%
Fog/Mist:	7	1.9%	Water/Sand:	1	0.3%
Crosswind/Blowing Sand:	1	0.3%	Repairing:	0	0.0%
Unspecified:	23	6.4%	Unspecified:	13	3.6%

Type of Vehicle	#VEH	%	Accident Severity Type	#ACC	%
Passenger Car:	532	74.0%	Fatal Collision:	1	0.3%
Bus:	19	2.6%	Injury Collision:	88	24.3%
Truck:	72	10.0%	PDO Collision:	273	75.4%
Taxi:	14	1.9%			
Minivan:	0	0.0%	Light Condition	#ACC	%
Police/Emergency Vehicle:	15	2.1%	Daylight:	204	56.4%
Motorcycle/Moped:	10	1.4%	Dawn/Dusk:	7	1.9%
Bicycle:	5	0.7%	Dark(Lighted):	135	37.3%
Fixed Object:	0	0.0%	Dark(Not Lighted):	3	0.8%
Unspecified:	52	7.2%	Dark(Unknown Lighting):	0	0.0%
			Unspecified:	13	3.6%

Contributing Factor	#VEH	%	Pedestrian Actions	#ACC	%
Driver: Speed:	11	1.5%	In Crosswalk with Signal:	1	10.0%
Driver: Alcohol/Drug:	12	1.7%	In Crosswalk against Signal:	1	10.0%
Driver: Electronic Device:	1	0.1%	In Crosswalk no Signal:	0	0.0%
Driver: Others:	131	18.2%	In Unmarked Crosswalk:	0	0.0%
Vehicle:	1	0.1%	Not in Crosswalk:	4	40.0%
Roadway:	2	0.3%	From Between Parked Cars:	1	10.0%
Unspecified:	561	78.0%	Unspecified:	3	30.0%

100 Records are not approved as of 9/2/2015 2:14:03 PM

Figure 3: Bladensburg Road and New York Avenue NE Crash Data

High Crash Intersection Site Visits

3.2. Recent and Planned Projects

DDOT has not made any major improvements to the intersection in some time, and there are not currently capital improvement plans for this location. Three photo-enforcement cameras operate at this location to detect red light running and speeding.

3.3. Site Visit Observations

Participants identified a number of issues related to all modes. Some may only require minor fixes, while others could require more substantial capital improvements. Many require further investigation and evaluation by DDOT. The timeline for next steps is included in the next section.

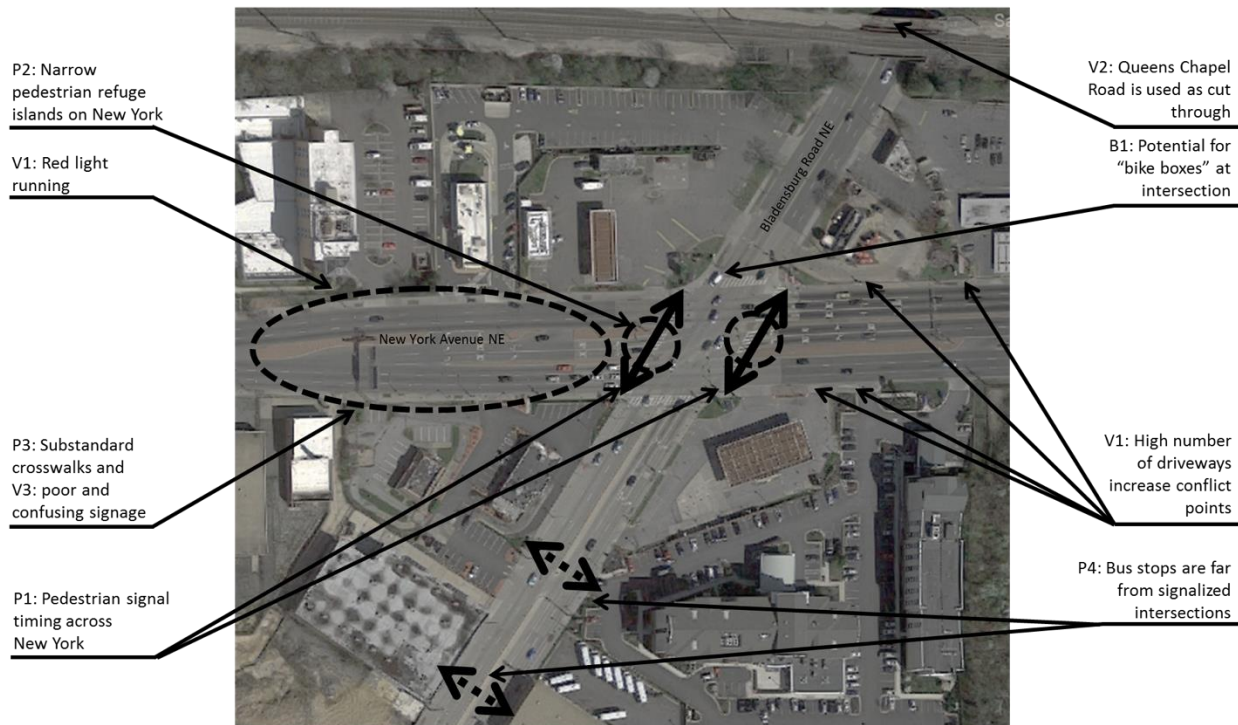

Figure 4: New York and Bladensburg Road NE Site Visit Observations

Pedestrian Issues:

P1. Signal timing for pedestrians is problematic. Leading Pedestrian Intervals or shifting left turns to lagging would give pedestrians a head start across the intersection. Participants also noted short crossing times overall and that pedestrians often must cross in two stages. Participants also

noted that trucks stopping at the intersection often obscure the pedestrian signals for those crossing New York Avenue. The eastern crossing of New York Avenue has higher pedestrian demand with hotel guests crossing to access restaurants. This is also a heavy right turn volume from WB New York Avenue to SB Bladensburg Road. The signal has a leading protected turn phase with right arrow, but eventually the green arrow turns into a green ball when the pedestrians get the walk signal. Drivers fail to yield the right-of-way and continue to turn right through the crosswalk even after pedestrians are present.

- P2. Pedestrian refuge islands along New York Avenue are small and may not be ADA compliant.
- P3. Pedestrian conditions along New York Avenue are substandard. Sidewalks have light poles in the middle of them and do not meet DDOT standards for width. Participants thought ADA conditions should be evaluated/retrofitted.
- P4. Bus stops are far from the intersection (south of New York Avenue near the Taco Bell) which encourages mid-block crossing. MPD positions an officer to serve as a school crossing guard there in the mornings. A HAWK signal or Rectangular Rapid Flashing Beacon (RRFB) could be ways to allow pedestrians to cross safely. At the intersection of T Street and Bladensburg Road, there is a “Tee” intersection with no labelled crosswalks. Consider warrants for a signalized intersection, pedestrian refuge, or HAWK signal.

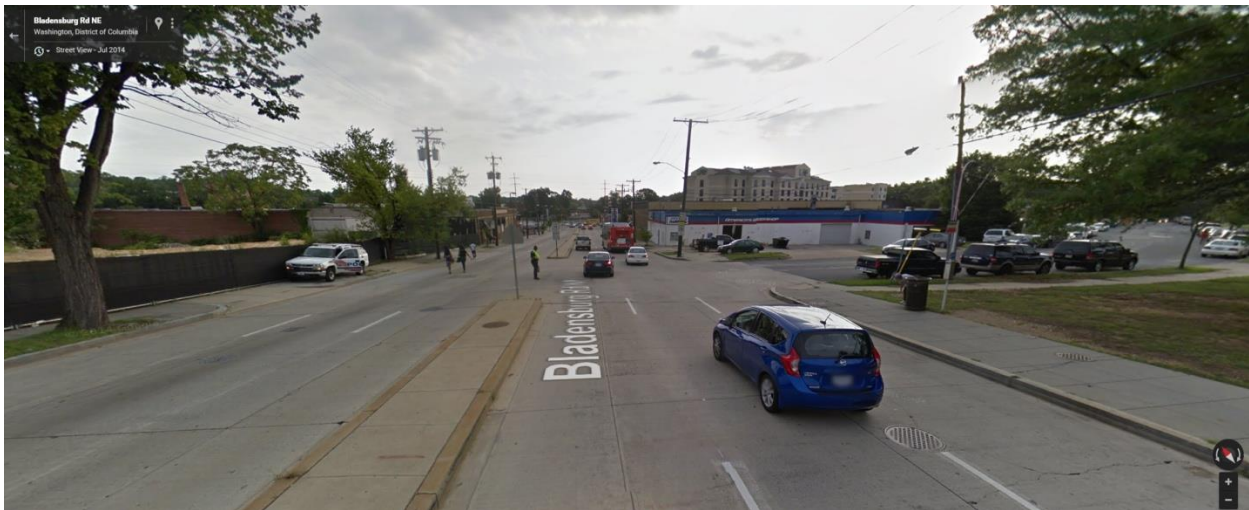

Figure 5: A police officer is regularly posted at the intersection of T Street and Bladensburg NE to facilitate pedestrian crossings and is visible in Google Street View.

High Crash Intersection Site Visits

Bicycle Issues:

- B1. There are fairly low bicycle volumes at this intersection, but there were nevertheless five bicyclist crashes during the analysis period. Participants discussed the potential to add bike boxes on the Bladensburg Road approaches. One participant said that he has difficulty turning from Bladensburg to Queens Chapel Road and requested a climbing lane on Queens Chapel Road.
- B2. The Fifth District Police Station on Bladensburg just south of the intersection needs bicycle racks. There are numerous community events held in this building and the existing bike racks are located in a secured area.

Vehicular Issues:

- V1. The large number of driveways complicate turning movements and increase conflict points. The high number of curb cuts presents safety and operational concerns for all users.
- V2. Participants mentioned that Queens Chapel Road gets used as a cut-through when traffic is congested along New York Avenue, including oversize and overweight trucks.
- V3. Participants discussed the potential to add better signage to New York and Bladensburg, including potentially mounting street signs to traffic signals. Some of the existing traffic signs are placed low on the poles, which limits visibility and impacts pedestrians as well.

3.4. Next steps

The following table identifies the next step for each issue and the associated timeline. Wherever possible, both design/evaluation and implementation timelines are noted, but further exploration for some issues may find potential solutions infeasible.

Issue	Next step	Timeline
Pedestrian Issues		
P1. Pedestrian crossings of New York Avenue	Evaluate signal timing and phasing, particularly NB Bladensburg right turn onto New York Ave.	Evaluation: January 2016 Implementation: March 2016
P2. Pedestrian refuge islands on New York	Evaluate ADA compliance and identify physical improvements.	Evaluation: January 2016 Implementation: TBD
P3. Pedestrian conditions along New York Avenue	Evaluate sidewalk needs. Widening sidewalks would be a major capital project, which is not currently budgeted.	Evaluation: January 2016 Implementation: TBD
P4. Bladensburg Road south of New York Avenue	Evaluate potential for HAWK or Rectangular Rapid Flashing Beacon (RRFB) and initiate design.	Evaluation: January 2016 Implementation: TBD
Bicycle Issues		
B1. Bike conditions at intersections	Assess potential for bike improvements at intersections along Bladensburg Road and Queens Chapel Road	Evaluation: January 2016 Installation: TBD
B2. Bicycle racks at Fifth District Police Station	Add location to DDOT installation database and schedule for installation.	Installation: Summer 2016
Vehicular Issues		
V1. Access management and curb cuts	Assess potential to close some driveways that do not meet DDOT standards.	Evaluation: February 2016
V2. Queens Chapel Road gets used as a cut-through when traffic is congested along NY Ave.	Work with MPD to evaluate potential photo enforcement, particularly for oversize/overweight vehicles.	Evaluation: February 2016
V3. Driver confusion and signage	Evaluate signage at intersections and upgrade as necessary.	Evaluation: January 2016 Implementation: March 2016

Table 3: Bladensburg Road and New York Avenue NE Next Steps

4.0 14th Street and U Street NW

14th Street and U Street is fairly typical signalized intersection, but processes approximately 40,000 vehicles per day, in addition to very high pedestrian, bicycle, and transit demands. The intersection is also at the center of the U Street nightlife/entertainment district, which presents some atypical demands from for-hire vehicles.

The September 1, 2015 site visit included staff from Councilmembers Cheh’s, Councilmember Nadeau’s Office, Councilmember Evans’ office, representatives from ANC 2B, ANC 1B, MPD staff, bicycle and pedestrian advocates, and members of the Bicycle and Pedestrian Advisory Councils.

4.1. Crash Data

During the analysis period, there were two fatalities and one disabling injury in this location. More than 10 percent of crashes involved pedestrians and bicyclists, and the 25 pedestrians and bicyclists involved in crashes was the highest for any of the five locations visited. Three of the pedestrian crashes involved pedestrians crossing in the crosswalk with the “walk” signal. More than one third of the crashes are sideswipes, which can be indicative of rapid lane changes in congested areas, in this case likely associated with the high volume of vehicular turning movements at the intersection, quick lane changes in response to double parking, or rapid changes to find parking. More than 10 percent of crashes involved taxis. Speed was a contributing factor in only two crashes. Over half of all crashes happen overnight, from 6:30pm to 7:30am. Figure 6 provides the summary report of crashes at this location.



DC Department of Transportation - Traffic Accident Reporting and Analysis System

Accident Summary Report (R-7)

Intersection: 14TH ST and U ST, NW

Time Period Covered: From 01/01/2012 To 08/01/2015

Prepared By: admin TARAS

Prepared Date: 9/2/2015

		Collision Type	#ACC	%	Collision Type	#ACC	%
Total Number of Accident:	208	Right Angle:	11	5.3%	Fixed Object:	4	1.9%
Total Number of Fatalities:	2	Left Turn:	16	7.7%	Ran Off Road:	1	0.5%
Total Number of Injuries:	43	Right Turn:	17	8.2%	Ped. Involved:	6	2.9%
Total Number of Disabling Injuries:	1	Rear End:	36	17.3%	Backing:	15	7.2%
Total Number of NonDisabling Injuries:	6	Side Swiped:	81	38.9%	Non Collision:	1	0.5%
Total Number of Pedestrians Involved:	10	Head On:	2	1.0%	Under/Over Ride:	0	0.0%
Total Number of Bicycles Involved:	15	Parked:	7	3.4%	Unspecified:	11	5.3%
Total Number of Motorcycles Involved:	7						

Time of Day	#ACC	%	Day of week	#ACC	%
07:30 ~ 09:30:	13	6.3%	Sunday:	34	16.3%
09:30 ~ 11:30:	28	13.5%	Monday:	35	16.8%
11:30 ~ 13:30:	12	5.8%	Tuesday:	22	10.6%
13:30 ~ 16:00:	23	11.1%	Wednesday:	22	10.6%
16:00 ~ 18:30:	15	7.2%	Thursday:	20	9.6%
18:30 ~ 07:30:	117	56.3%	Friday:	25	12.0%
Unspecified:	0	0.0%	Saturday:	50	24.0%

Weather Condition	#ACC	%	Surface Condition	#ACC	%
Clear:	181	87.0%	Dry:	178	85.6%
Rain:	15	7.2%	Wet:	19	9.1%
Snow:	2	1.0%	Snow/Ice:	1	0.5%
Sleet/Hail:	0	0.0%	Slush:	0	0.0%
Fog/Mist:	0	0.0%	Water/Sand:	0	0.0%
Crosswind/Blowing Sand:	0	0.0%	Repairing:	0	0.0%
Unspecified:	10	4.8%	Unspecified:	10	4.8%

Type of Vehicle	#VEH	%	Accident Severity Type	#ACC	%
Passenger Car:	244	60.0%	Fatal Collision:	2	1.0%
Bus:	33	8.1%	Injury Collision:	39	18.8%
Truck:	35	8.6%	PDO Collision:	167	80.3%
Taxi:	42	10.3%			
Minivan:	0	0.0%	Light Condition	#ACC	%
Police/Emergency Vehicle:	5	1.2%	Daylight:	97	46.6%
Motorcycle/Moped:	8	2.0%	Dawn/Dusk:	3	1.4%
Bicycle:	15	3.7%	Dark(Lighted):	99	47.6%
Fixed Object:	0	0.0%	Dark(Not Lighted):	0	0.0%
Unspecified:	25	6.1%	Dark(Unknown Lighting):	0	0.0%
			Unspecified:	9	4.3%

Contributing Factor	#VEH	%	Pedestrian Actions	#ACC	%
Driver: Speed:	2	0.5%	In Crosswalk with Signal:	3	37.5%
Driver: Alcohol/Drug:	6	1.5%	In Crosswalk against Signal:	1	12.5%
Driver: Electronic Device:	0	0.0%	In Crosswalk no Signal:	0	0.0%
Driver: Others:	72	17.7%	In Unmarked Crosswalk:	0	0.0%
Vehicle:	0	0.0%	Not in Crosswalk:	1	12.5%
Roadway:	2	0.5%	From Between Parked Cars:	0	0.0%
Unspecified:	325	79.9%	Unspecified:	3	37.5%

44 Records are not approved as of 9/2/2015 2:15:35 PM

Figure 6: 14th Street and U Street NW Crash Data

4.2. Recent and Planned Projects

The intersection of 14th Street and U Street in Northwest will be included in the scope of work for the 14th Street Streetscape project. The project is currently in design and 90% complete, and already incorporates a number of improvements to the intersection. The design phase of this project will

High Crash Intersection Site Visits

conclude in winter 2016, and construction, which will cost approximately \$10 million, is anticipated to begin in fall of 2016. The streetscape project is a potential mechanism to incorporate additional items and refinements identified during the site visit.

Figure 7 is an overview of the project boundaries and Figure 8 is an image of the proposed signs and marking plan, which depicts the following changes:

- Bulb-outs at each corner to improve pedestrian crossing safety through reducing the crossing distance.
- Bus Bulb outs along 14th Street, north of the intersection to improve boarding and alighting.
- Pavement Markings for a bike lane on 14th Street and a bike box at the intersection of 14th and U Streets.
- ADA compliant sidewalks and curb-ramps.
- New streetlights and signals with Audible Pedestrian Signal pushbuttons.
- Pavement milling and overlay with new pavement markings, including high visibility crosswalks.



Figure 7: 14th Street NW Streetscape Project Boundaries

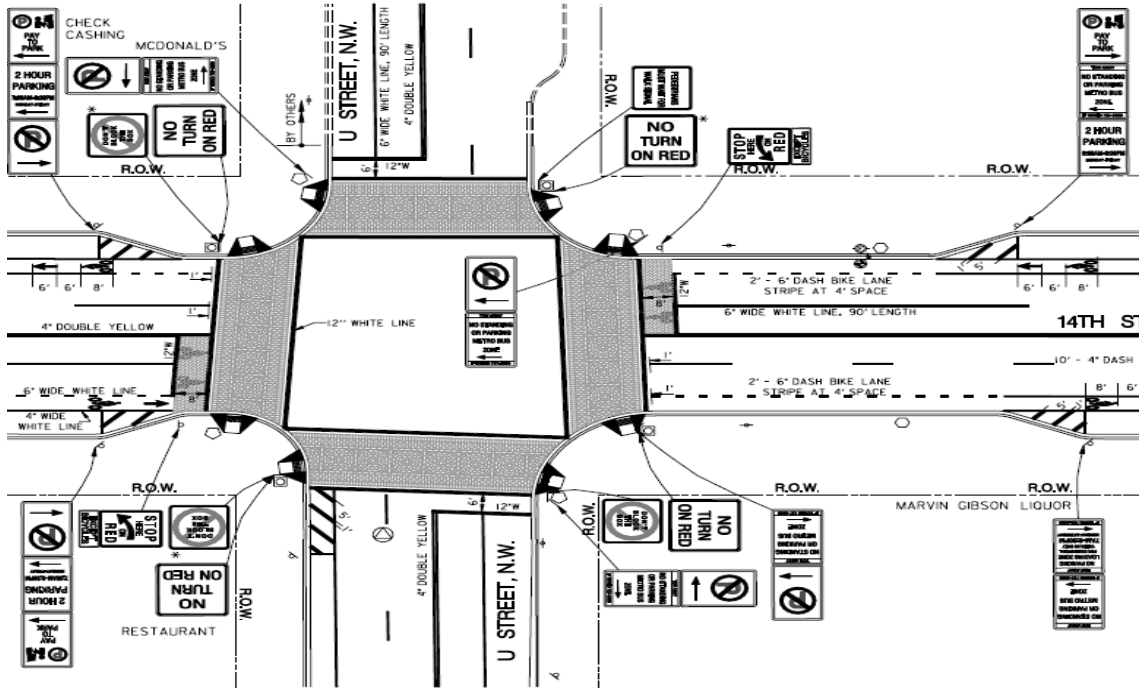

Figure 8: 14th Street NW and U Street Intersection – Signage and Pavement Marking Plan

Participants in the site visit asked about the potential for short term or “interim” improvements. There is currently \$75,000 to \$125,000 available from the 13th and U development, which may be used to support traffic safety improvements in the area.

4.3. Site Visit Observations

Participants identified a number of issues related to all modes. Some may only require minor fixes, while others could require more substantial capital improvements. Many will also require further investigation and evaluation by DDOT. The timeline for next steps is included in the next section.

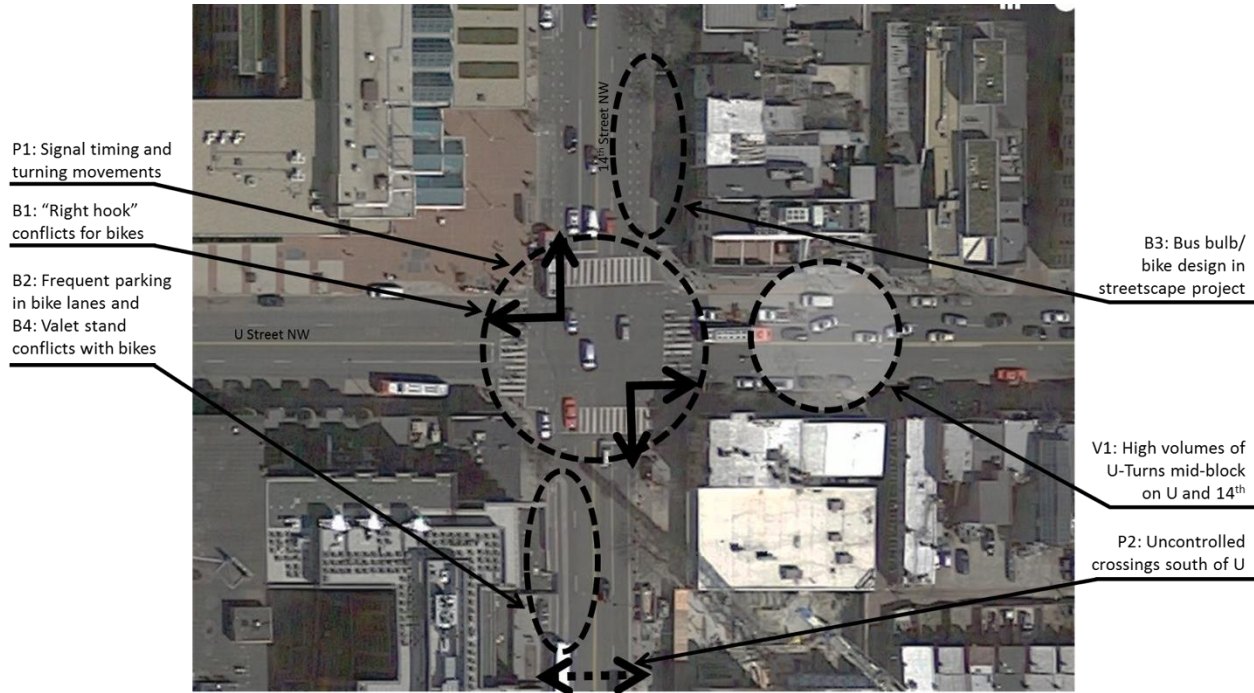

Figure 9: 14th and U Street NW Site Visit Observations

Pedestrian Issues:

- P1. Participants discussed signal timing issues overall and concepts such as a diagonal crosswalk and “Barnes Dance” timing, as well as modifying signal timing to prioritize pedestrians. Participants discussed the potential to evaluate signal timing to restrict turning movements while pedestrians are crossing. The leading left for NB 14th Street onto WB U Street is problematic, as pedestrians often violate the exclusive left turn phase and drivers are stuck in the intersection.
- P2. There are several uncontrolled pedestrian crossings along 14th Street south of U Street. A 2013 DDOT evaluation found that these locations do not warrant HAWK signals, but other improvements in visibility and safety may be possible. Recent repaving also has left some intersections without full crosswalk markings.
- P3. There is heavy pedestrian traffic during late night conditions at the intersection, mostly on Fridays and weekends. Participants identified the potential for a Traffic Control Officer (TCO) to be stationed in high pedestrian volume periods.

High Crash Intersection Site Visits



Bicycle Issues:

- B1. There are concerns with “right hooks” for bikes (when vehicles turn across a bike lane and collide with people biking) along 14th Street. Green pavement markings and stronger markings continuing through intersections may be improvements to highlight the visibility of people biking.
- B2. Participants noted seeing parking in bike lanes frequently, especially at Trader Joe’s.
- B3. The streetscape project incorporates bus bulb outs at the intersection, but these could be a concern for people biking if they are not well integrated into the final design.
- B4. Valet stands conflict with bike lanes and result in parking/pick-up/drop-off in the bike lanes.

Vehicular Issues:

- V1. Participants discussed the high volume of U-Turns mid-block along U Street and 14th Street, especially by for-hire vehicles during evenings and weekends, and the potential for delineators or bollards to discourage this behavior.
- V2. Participants asked for information from MPD on speed cameras.

4.4. Next steps

The following table identifies the next step for each issue and the associated timeline. Wherever possible, both design/evaluation and implementation timelines are noted, but further exploration for some issues may find potential solutions infeasible.

Issue	Next step	Timeline
Pedestrian Issues		
P1. Pedestrian crossings and signal timing	Evaluate signal timing to see if more walk time can be given, including the potential for a “Barnes Dance”.	Evaluation: January 2016 Implementation: March 2016
P2. Pedestrian crossings on 14 th Street corridor	Evaluate potential for HAWK signals or Rectangular Rapid Flashing Beacon (RRFB) and ensure appropriate crosswalk are markings in place.	Evaluation: January 2016 Implementation: TBD
P3. Late night/weekend pedestrian volumes	Evaluate potential for a dedicated Traffic Control Officer (TCO) to manage high pedestrian volume periods.	Evaluation: February 2016

High Crash Intersection Site Visits



Issue	Next step	Timeline
Bicycle Issues		
B1. Turning movement conflicts for bikes	Identify interim treatments prior to streetscape project construction, such as green paint treatment.	Design: March 2016 Installation: May 2016
B2. Parking in bike lanes	Work with DPW and MPD to improve enforcement of parking in bike lanes.	Ongoing
B3. Potential conflicts between “bus bulbs” and bikes	Refine streetscape design to address safety for all users.	Design: January 2016 Construction: 2017
B4. Valet stand conflicts with bike lanes	Work with permit holders to improve compliance, including enforcement.	January 2016
Vehicle Issues		
V1. U-Turns mid-block along U Street and 14 th Street	Work with DCTC and MPD to address U-turns, especially by for-hire vehicles.	Ongoing
V2. Speeding in corridor	Work with MPD to evaluate potential photo enforcement locations.	January 2016

Table 4: 14th Street and U Street NW Next Steps

5.0 Minnesota Avenue and Benning Road NE

Minnesota Avenue and Benning Road NE is a heavily traveled intersection that serves substantial demand by vehicles and pedestrians. Over 40,000 vehicles per day traverse the intersection, with high turn volumes, particularly from Minnesota Avenue towards westbound Benning Road. Multiple Metrobus lines serve the intersection, connecting to the Minnesota Avenue Metrorail station and points farther east on Benning Road and south on Minnesota Avenue.

The September 2, 2015 site visit included staff from Councilmembers Cheh's office, MPD staff, bicycle and pedestrian advocates, and members of the Bicycle and Pedestrian Advisory Councils.

5.1. Crash Data

There were 206 crashes at this intersection during the analysis period, more than 10 percent of which involved left turns. Over 50 percent involved either rear end or side swipes, which is consistent with both the congestion and the heavy turn volumes. While there were no fatalities during the analysis period, there were four disabling injuries. Sixteen pedestrians and five bicyclists were involved in the crashes, the highest pedestrian total and the second highest combined pedestrian/bicyclist total of the five locations. Four of the pedestrians were hit in the crosswalk crossing with the "walk" signal, and another four were crossing outside of the crosswalk, an issue that is highlighted and discussed below. There were also a number of crashes related to speed or alcohol use, including four speed-related crashes. Figure 10 provides the summary report of crashes at this location.



DC Department of Transportation - Traffic Accident Reporting and Analysis System

Accident Summary Report (R-7)

Intersection: MINNESOTA AVE and BENNING RD, NE			Time Period Covered: From 01/01/2012 To 08/01/2015			Prepared By: admin TARAS			Prepared Date: 9/2/2015		
Total Number of Accident:	206		Collision Type	#ACC	%	Collision Type	#ACC	%			
Total Number of Fatalities:	0		Right Angle:	4	1.9%	Fixed Object:	6	2.9%			
Total Number of Injuries:	101		Left Turn:	21	10.2%	Ran Off Road:	0	0.0%			
Total Number of Disabling Injuries:	4		Right Turn:	9	4.4%	Ped. Involved:	16	7.8%			
Total Number of NonDisabling Injuries:	14		Rear End:	59	28.6%	Backing:	7	3.4%			
Total Number of Pedestrians Involved:	16		Side Swiped:	65	31.6%	Non Collision:	2	1.0%			
Total Number of Bicycles Involved:	5		Head On:	5	2.4%	Under/Over Ride:	1	0.5%			
Total Number of Motorcycles Involved:	2		Parked:	1	0.5%	Unspecified:	10	4.9%			
Time of Day			Day of week								
07:30 ~ 09:30:	19	9.2%	Sunday:	17	8.3%						
09:30 ~ 11:30:	13	6.3%	Monday:	23	11.2%						
11:30 ~ 13:30:	19	9.2%	Tuesday:	43	20.9%						
13:30 ~ 16:00:	35	17.0%	Wednesday:	29	14.1%						
16:00 ~ 18:30:	54	26.2%	Thursday:	31	15.0%						
18:30 ~ 07:30:	66	32.0%	Friday:	41	19.9%						
Unspecified:	0	0.0%	Saturday:	22	10.7%						
Weather Condition			Surface Condition								
Clear:	174	84.5%	Dry:	170	82.5%						
Rain:	21	10.2%	Wet:	27	13.1%						
Snow:	0	0.0%	Snow/Ice:	0	0.0%						
Sleet/Hail:	0	0.0%	Slush:	0	0.0%						
Fog/Mist:	3	1.5%	Water/Sand:	0	0.0%						
Crosswind/Blowing Sand:	1	0.5%	Repairing:	3	1.5%						
Unspecified:	7	3.4%	Unspecified:	6	2.9%						
Type of Vehicle			Accident Severity Type								
Passenger Car:	273	70.9%	Fatal Collision:	0	0.0%						
Bus:	42	10.9%	Injury Collision:	70	34.0%						
Truck:	23	6.0%	PDO Collision:	136	66.0%						
Taxi:	2	0.5%	Light Condition								
Minivan:	0	0.0%	Daylight:	139	67.5%						
Police/Emergency Vehicle:	4	1.0%	Dawn/Dusk:	7	3.4%						
Motorcycle/Moped:	4	1.0%	Dark(Lighted):	54	26.2%						
Bicycle:	5	1.3%	Dark(Not Lighted):	0	0.0%						
Fixed Object:	0	0.0%	Dark(Unknown Lighting):	0	0.0%						
Unspecified:	32	8.3%	Unspecified:	6	2.9%						
Contributing Factor			Pedestrian Actions								
Driver: Speed:	4	1.0%	In Crosswalk with Signal:	4	25.0%						
Driver: Alcohol/Drug:	9	2.3%	In Crosswalk against Signal:	2	12.5%						
Driver: Electronic Device:	0	0.0%	In Crosswalk no Signal:	1	6.3%						
Driver: Others:	69	17.9%	In Unmarked Crosswalk:	0	0.0%						
Vehicle:	2	0.5%	Not in Crosswalk:	4	25.0%						
Roadway:	1	0.3%	From Between Parked Cars:	0	0.0%						
Unspecified:	300	77.9%	Unspecified:	5	31.3%						

49 Records are not approved as of 9/2/2015 2:14:44 PM

Figure 10: Minnesota Avenue and Benning Road NE Crash Data

5.2. Recent and Planned Projects

The Minnesota Avenue, N.E. Revitalization Phase II Project, encompassing a segment of the roadway 300 feet south of Benning Road to Sheriff Road, is currently under design, and the design team is

High Crash Intersection Site Visits

preparing to submit 90% plans for review. The Phase II design plan is a continuation of the Phase I plan (which encompassed the section south of Benning Road), and includes intersection improvements, lane and median reconfiguration, pavement reconstruction, driveway and sidewalk adjustments, streetlights upgrades, new traffic signals, drainage improvements, landscape and streetscape improvements, and the undergrounding of Pepco’s primary feeder line.

The design is anticipated to be complete in spring 2016, with the potential construction advertisement in fall 2016. The project will implement some physical upgrades to the intersection, including a new refuge island, upgraded curb ramps, and upgraded markings. The signage and marking plan is shown in Figure 11.

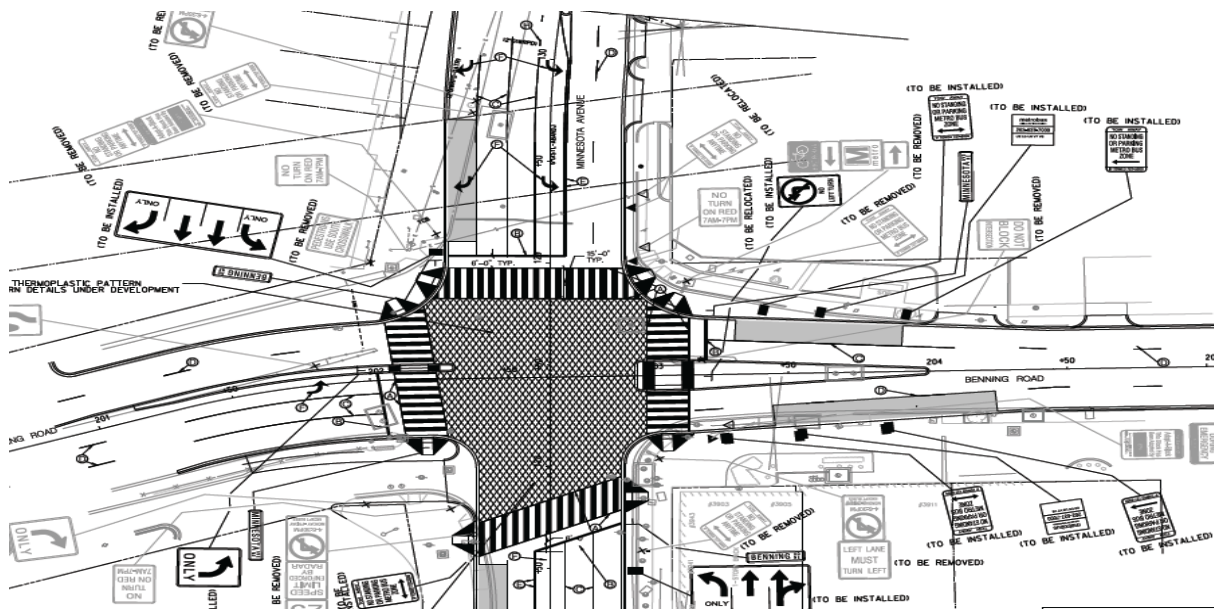

Figure 11: Minnesota Avenue and Benning Road Intersection – Signage and Pavement Markings

The Benning Road Streetcar Extension Environmental Assessment is also ongoing. The Environmental Assessment envisions additional modifications to traffic conditions at the intersection in conjunction with the reconstruction of the bridge, and the eastern expansion of the existing H Street/Benning Road Line. Improvements would include better pedestrian conditions crossing the bridge towards the downtown area and a lengthening of the eastbound left turn bay. The Environmental Assessment is expected to be complete in winter 2016, with a potential Finding of No Significant Impact (FONSI) by mid-year. However, the physical improvements from the streetcar extension are still likely several years away from construction.

High Crash Intersection Site Visits

5.3. Site Visit Observations

Participants identified a number of issues related to all modes. Some may only require minor fixes, while others could require more substantial capital improvements. Many will also require further investigation and evaluation by DDOT. The timeline for next steps is included in the next section.

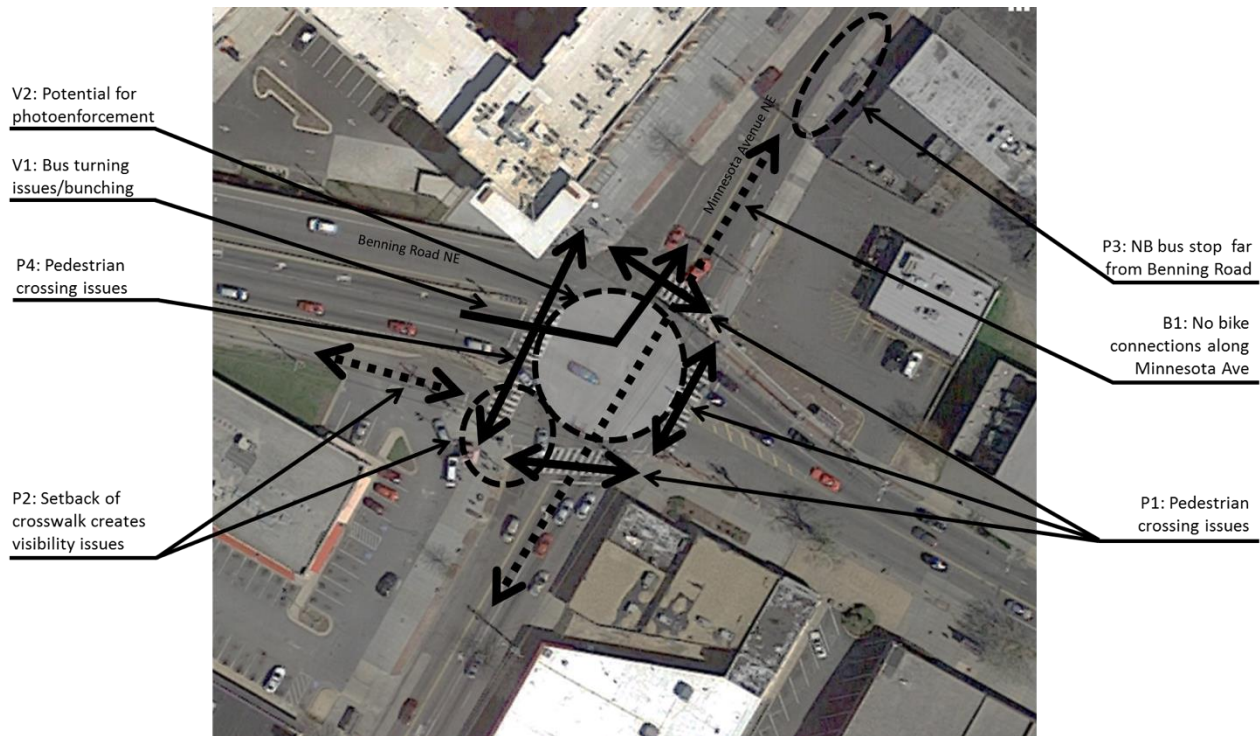

Figure 12: Minnesota Avenue and Benning Road NE Site Visit Observations

Pedestrian Issues:

- P1. Participants discussed improvements such as high visibility crosswalks, signage, and longer pedestrian crossing times to improve the safety of the intersection.
- P2. The setback of the crosswalk on Minnesota south of Benning creates visibility challenges for turning vehicles. The setback is created because of the access road along the bridge that services an industrial site.
- P3. There is the potential to relocate the northbound bus stop located at Minnesota Avenue north of Benning Road to the south and closer to the intersection. This would require modifications to an existing driveway, and needs to be evaluated for bus turning movement and operations. There is also the potential to move the southbound bus stop closer to intersection prior to

High Crash Intersection Site Visits

Phase II project. This would require relocation of the bus shelter, but would improve pedestrian crossings and minimize violations for transfers.

- P4. Participants discussed several ideas for improving the crossing of Benning Road on the west side of Minnesota, particularly to address the heavy eastbound to southbound right turn movements that are taken at relatively high speeds. One idea included a pedestrian “refuge” created with flex posts in anticipation of the Phase II project (see Figure 13) and Installation of R10-15 (“Turning Vehicles Yield to Pedestrians”) signs on the NW corner pole facing the southbound right turning drivers, and the SW corner pole facing the eastbound right turning drivers. Another idea was to make the protected signal phase for the northbound left turn to westbound Benning “lagging”, rather than “leading”. This would reduce non-compliance by pedestrians, and could permit a Leading Pedestrian Interval.

Bicycle Issues:

- B1. The intersection is fairly difficult to navigate by bicycle, because of the high turn volumes and narrow roadways. Participants discussed the potential for a bike lane along Minnesota Avenue. While this may be challenging due to traffic and transit volumes, the area can be evaluated for bike facility opportunities.

Vehicle Issues:

- V1. Participants discussed bus bunching of the X2 articulated buses making the eastbound left turn to Minnesota Avenue.
- V2. Participants noted the challenges with red light running and intersection blocking in general, particularly near the fire station on Minnesota north of the Benning Road intersection.

5.4. Next steps

The following table identifies the next step for each issue and the associated timeline. Wherever possible, both design/evaluation and implementation timelines are noted, but further exploration for some issues may find potential solutions infeasible.



Issue	Next step	Timeline
Pedestrian Issues		
P1. Pedestrian crossings improvements.	Evaluate for inclusion in the Phase II project, and/or shorter-term markings upgrades.	Design: March 2016 Potential interim markings: May 2016 Phase II construction: 2017
P2. Setback of south side Minnesota Avenue pedestrian crossing	Short: improve visibility of crosswalk. Long: reconfigure access and straighten crossing.	Short: with Phase II construction. Long: TBD
P3. Bus stop locations	Evaluate bus stop relocations with WMATA in near term and through capital projects.	Evaluation: February 2016 Implementation: TBD
P4. Benning Road pedestrian crossing	Evaluate signal timing and potential for temporary “refuge”.	Evaluation: March 2016 Implementation: May 2016
Bicycle Issues		
B1. Bike access on Minnesota	Identify potential bicycle access improvements.	Evaluation: March 2016 Implementation: TBD
Vehicle Issues		
V1. Signal operations for transit vehicles.	Evaluate phasing, especially for EB to NB X2 bus.	Evaluation: January 2016 Implementation: March 2016
V2. Driver behavior, including blocking the box and red light running.	Evaluate photo enforcement opportunities with MPD and/or TCO presence. Move “Do not block firehouse” sign closer to the station.	Evaluation: February 2016 Implementation: TBD

Table 5: Benning Road and Minnesota Avenue NE Next Steps



Figure 13: Mock-up of Potential Interim "Pedestrian Refuge" on West Side Crossing of Benning Road.

6.0 M Street and Wisconsin Avenue NW

M Street and Wisconsin Avenue NW is at the heart of the Georgetown shopping district and serves a busy mix of vehicles, bicyclists, pedestrians, and transit vehicles. Approximately 35,000 vehicles use the intersection daily, and pedestrian volumes are high, especially on weekends.

The site visit was held on Friday, September 4, 2015 at 9am. Attendees included DDOT staff, Councilmember Cheh, ANC 2E, Georgetown BID, WABA, All Walks DC, and the Pedestrian and Bicycle Advisory Councils. The intersection experiences high turning volumes, a high bus volume demand, and heavy peak-period demand by all modes of travel. The M Street corridor itself is a congested vehicular route on a daily basis, particularly leading towards the Key Bridge.

6.1. Crash Data

The crash data shows fairly low severity, with two disabling injuries and no fatalities during the analysis period. Almost half of all crashes were sideswipes, indicative of an intersection with heavy turn volumes and can also be representative of a location with lane changing or high parking demand/turnover. There were 12 pedestrians and nine bicyclists involved in crashes, the second highest combined total of the five intersections. A third of pedestrians were not in crosswalks, an issue discussed further below. There are high rates of taxi involvement in crashes, and heavy vehicles (buses and trucks) make up almost one quarter of vehicles involved in crashes. Figure 14 provides the summary report of crashes at this location.



DC Department of Transportation - Traffic Accident Reporting and Analysis System

Accident Summary Report (R-7)

Intersection: WISCONSIN AVE and M ST, NW

Time Period Covered: From 01/01/2012 To 08/01/2015

Prepared By: admin TARAS

Prepared Date: 9/2/2015

Total Number of Accident:	195	Collision Type	#ACC	%	Collision Type	#ACC	%
Total Number of Fatalities:	0	Right Angle:	7	3.6%	Fixed Object:	2	1.0%
Total Number of Injuries:	36	Left Turn:	16	8.2%	Ran Off Road:	0	0.0%
Total Number of Disabling Injuries:	2	Right Turn:	14	7.2%	Ped. Involved:	11	5.6%
Total Number of NonDisabling Injuries:	12	Rear End:	27	13.8%	Backing:	12	6.2%
Total Number of Pedestrians Involved:	12	Side Swiped:	88	45.1%	Non Collision:	1	0.5%
Total Number of Bicycles Involved:	9	Head On:	2	1.0%	Under/Over Ride:	0	0.0%
Total Number of Motorcycles Involved:	3	Parked:	2	1.0%	Unspecified:	13	6.7%

Time of Day	#ACC	%	Day of week	#ACC	%
07:30 ~ 09:30:	7	3.6%	Sunday:	24	12.3%
09:30 ~ 11:30:	19	9.7%	Monday:	17	8.7%
11:30 ~ 13:30:	31	15.9%	Tuesday:	27	13.8%
13:30 ~ 16:00:	42	21.5%	Wednesday:	27	13.8%
16:00 ~ 18:30:	35	17.9%	Thursday:	27	13.8%
18:30 ~ 07:30:	61	31.3%	Friday:	38	19.5%
Unspecified:	0	0.0%	Saturday:	35	17.9%

Weather Condition	#ACC	%	Surface Condition	#ACC	%
Clear:	166	85.1%	Dry:	166	85.1%
Rain:	18	9.2%	Wet:	22	11.3%
Snow:	1	0.5%	Snow/Ice:	0	0.0%
Sleet/Hail:	1	0.5%	Slush:	2	1.0%
Fog/Mist:	1	0.5%	Water/Sand:	0	0.0%
Crosswind/Blowing Sand:	1	0.5%	Repairing:	1	0.5%
Unspecified:	7	3.6%	Unspecified:	4	2.1%

Type of Vehicle	#VEH	%	Accident Severity Type	#ACC	%
Passenger Car:	188	49.7%	Fatal Collision:	0	0.0%
Bus:	52	13.8%	Injury Collision:	31	15.9%
Truck:	34	9.0%	PDO Collision:	164	84.1%
Taxi:	65	17.2%			
Minivan:	0	0.0%	Light Condition	#ACC	%
Police/Emergency Vehicle:	5	1.3%	Daylight:	131	67.2%
Motorcycle/Moped:	3	0.8%	Dawn/Dusk:	6	3.1%
Bicycle:	9	2.4%	Dark(Lighted):	55	28.2%
Fixed Object:	0	0.0%	Dark(Not Lighted):	1	0.5%
Unspecified:	22	5.8%	Dark(Unknown Lighting):	0	0.0%
			Unspecified:	2	1.0%

Contributing Factor	#VEH	%	Pedestrian Actions	#ACC	%
Driver: Speed:	2	0.5%	In Crosswalk with Signal:	2	16.7%
Driver: Alcohol/Drug:	1	0.3%	In Crosswalk against Signal:	0	0.0%
Driver: Electronic Device:	0	0.0%	In Crosswalk no Signal:	0	0.0%
Driver: Others:	77	20.4%	In Unmarked Crosswalk:	0	0.0%
Vehicle:	0	0.0%	Not in Crosswalk:	4	33.3%
Roadway:	0	0.0%	From Between Parked Cars:	0	0.0%
Unspecified:	298	78.8%	Unspecified:	6	50.0%

52 Records are not approved as of 9/2/2015 2:12:38 PM

Figure 14: M Street and Wisconsin Avenue NW Crash Data

6.2. Recent and Planned Projects

DDOT does not have major planned projects at M and Wisconsin NW, and the last major project ended more than five years ago.

High Crash Intersection Site Visits

6.3. Site Visit Observations

Participants identified a number of issues related to all modes. Some may only require minor fixes, while others could require more substantial capital improvements. Many will also require further investigation and evaluation by DDOT. The timeline for next steps is included in the next section.

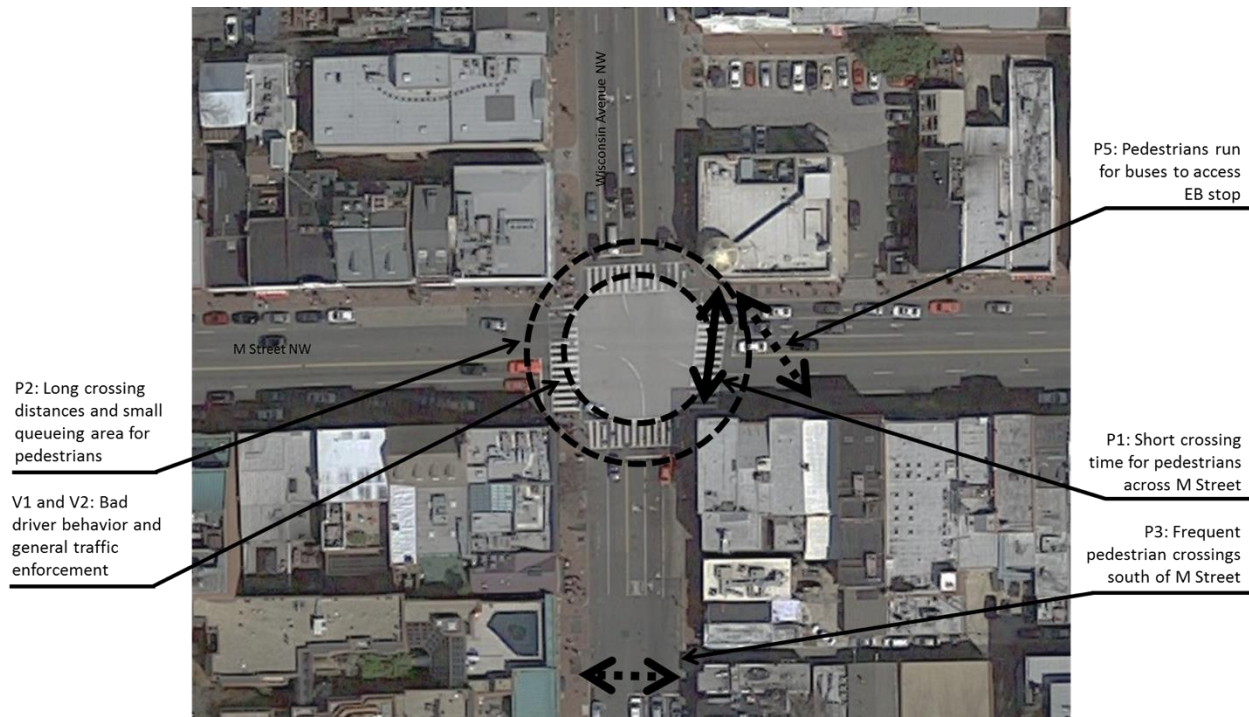

Figure 15: M Street and Wisconsin Avenue NW Site Visit Observations

Pedestrian Issues:

- P1. Pedestrians have 16 seconds to cross M Street in the eastern crosswalk, and pedestrians are often still crossing as the phase ends. There was discussion of a possible “Barnes Dance” to permit diagonal crossings.
- P2. There are long crossing distances and small queuing areas for pedestrians, especially on weekends. Curb extensions may be possible on the NW, SW, and SE corners (see Figure 16).
- P3. There are frequent pedestrian crossings on Wisconsin outside of crosswalk south of M Street. A marked crossing at the canal could reduce some of the demand on the M Street crosswalk and make an existing pedestrian behavior safer.
- P4. There are high volumes of pedestrians in evenings and weekends when vehicular demands are different. Attendees mentioned that some of the highest volume pedestrian times do not

High Crash Intersection Site Visits

coincide with highest volume vehicular demands, so additional timing plans giving more time for pedestrians could be possible at these times.

P5. Pedestrians run for buses, particularly for buses accessing eastbound M Street stop east of Wisconsin. There were suggestions to move the stop farther east, to 31st Street or to have “mini-layovers” built into schedules which would allow pedestrians to miss the signal cycle but still catch the bus without jaywalking.

Bicycle Issues:

- No specific bicycle issues were discussed during the site visit. It is likely that the pedestrian and vehicle issues also impact overall bicycle safety.

Vehicle Issues:

V1. The participants cited bad driver behavior at this intersection, particularly the running of red lights and blocking the intersection. The ANC and BID have requested red light cameras and MPD has previously indicated willingness to install, but sight lines and access are challenging.

V2. There are significant vehicular demands from at many times of day and very high turn volumes at this location. Interactions between drivers and pedestrians, especially during turns, create some safety hazards. More proactive management of the intersection may be necessary, and the Georgetown BID has requested additional TCO deployment at this location.

6.4. Next steps

The following table identifies the next step for each issue and the associated timeline. Wherever possible, both design/evaluation and implementation timelines are noted, but further exploration for some issues may find potential solutions infeasible.

Issue	Next Step	Timeline
Pedestrian Issues		
P1. Short crossing time for pedestrians across M Street	Evaluate signal timing to see if more walk time can be given or if alternative phasing is possible.	Evaluation: January 2016 Implementation: March 2016
P2. Long crossing distances and small queuing areas for pedestrians, especially on weekends	Explore “temporary” curb extensions, installed with paint and potentially flex posts in order to test the feasibility. (Figure 16)	Evaluation: March 2016 Implementation: May 2016

High Crash Intersection Site Visits



Issue	Next Step	Timeline
P3. Frequent pedestrian crossings on Wisconsin outside of crosswalk south of M Street	Explore feasibility of new crossing, particularly south of M Street across Wisconsin Avenue.	Evaluation: March 2016 Implementation: TBD
P4. High pedestrian volumes coincide with off-peak auto times	Evaluate potential for additional signal timing plans during non-peak times.	Evaluation: March 2016 Implementation: May 2016
P5. Pedestrians run for buses, particularly for buses accessing eastbound M Street stop east of Wisconsin.	Evaluate potential for bus stop location changes.	Evaluation: January 2016 Implementation: TBD
Bicycle Issues		
- No specific bicycle issues were discussed during the site visit.		
Vehicle Issues		
V1. Bad driver behavior, particularly running red lights and blocking box	ANC and BID have requested red light camera and MPD has previously indicated willingness to install, but sight lines and access are challenging.	Evaluation: January 2016 Implementation: TBD
V2. Traffic and turning movement volumes.	Evaluate whether TCO deployment can be accommodated as well as signal timing changes to minimize pedestrian/vehicle conflicts.	Evaluation: January 2016

Table 6: M Street and Wisconsin Avenue NW Next Steps

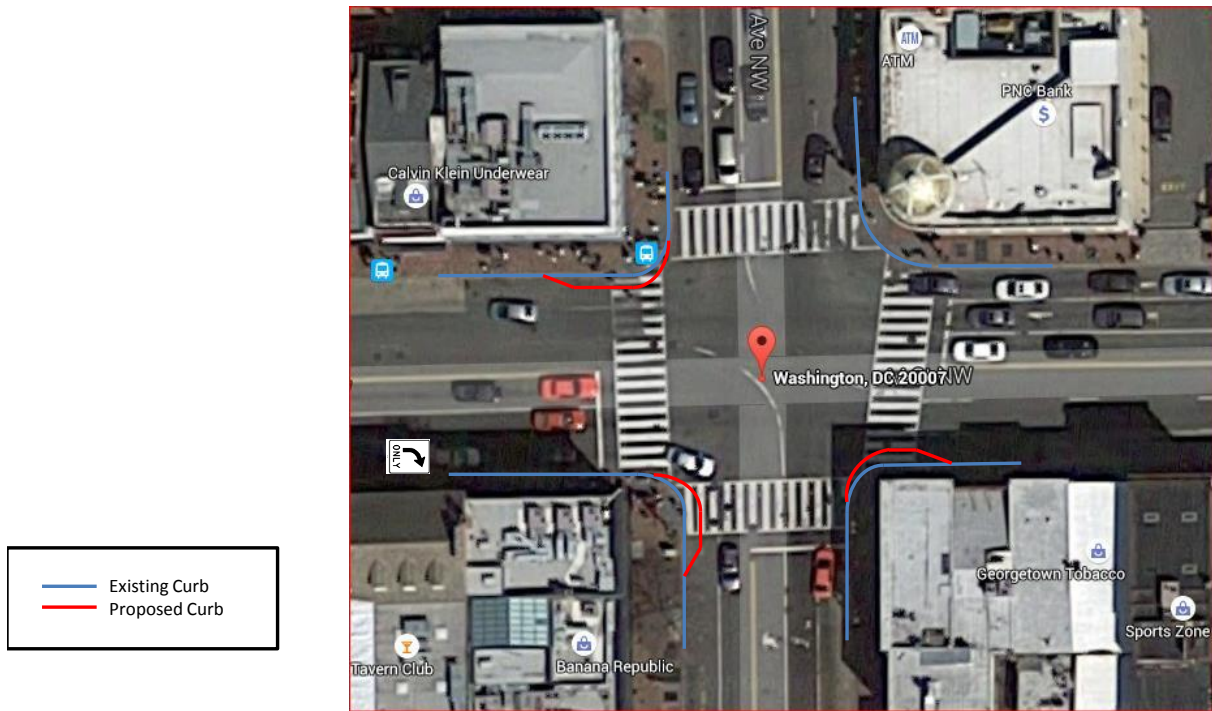

Figure 16: Conceptual Layout for Curb Extensions.

7.0 Conclusion

The high crash intersection site visit process was a useful exercise in which key stakeholders developed a common understanding of transportation safety issues and quickly evaluated a number of different issues in specific locations.

The theme of the site visits coalesces well with the District’s Vision Zero Initiative to eliminate transportation fatalities and serious injuries within 10 years as Vision Zero will require concerted and collaborative effort from a number of stakeholders. These intersection evaluations and improvements are important early actions in achieving the vision, along with the engineering, infrastructure, and enforcement changes at these locations. This collaborative approach to improving data collection and analysis and engaging regularly with key stakeholders will enable us to identify and address safety issues more effectively.

DDOT expects to institutionalize this process more formally, and accelerate the time to summarize and evaluate the site visits. The agency will identify five additional locations for site visits in early Spring 2016.

8.0 Appendix A: Large Format Location Issue Maps

First Street and Massachusetts Avenue NE

P3/B2: Bike/Ped conflicts at trail

P1: Short crossing time across Mass

V1: Red light running

B1: Difficult L turn for WB bikes

P2: Lack of marked crosswalks

B3: EB "floating" bike lane safety

V3: Parking in "No Parking" areas

B4: Connections from Bikeshare to Mass Avenue

V2: Driver confusion on Columbus Plaza

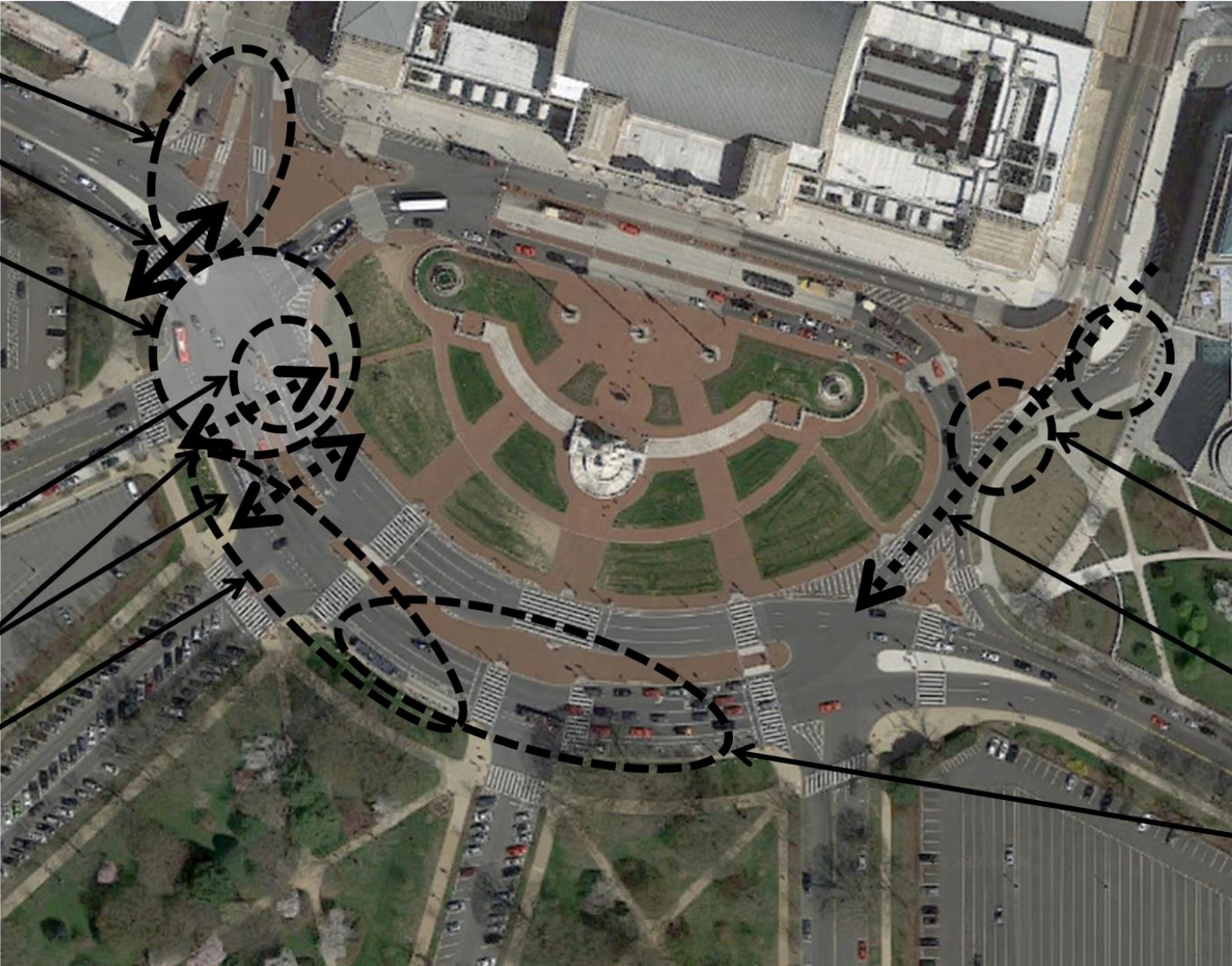

Bladensburg Road and New York Avenue NE

P2: Narrow pedestrian refuge islands on New York

V1: Red light running

P3: Substandard crosswalks and V3: poor and confusing signage

P1: Pedestrian signal timing across New York

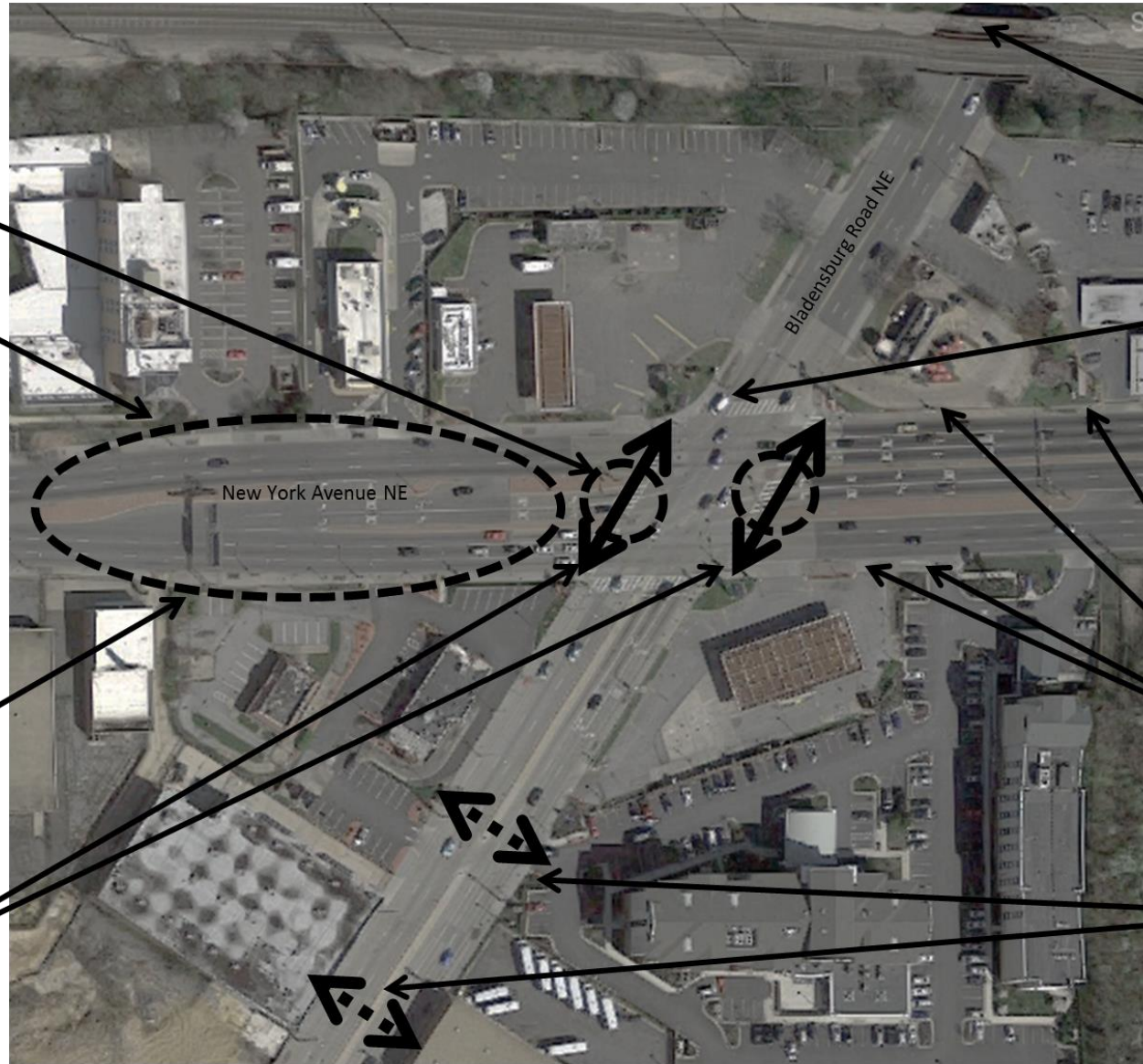

V2: Queens Chapel Road is used as cut through

B1: Potential for "bike boxes" at intersection

V1: High number of driveways increase conflict points

P4: Bus stops are far from signalized intersections

14th and U Street NW

P1: Signal timing and turning movements

B1: "Right hook" conflicts for bikes

B2: Frequent parking in bike lanes and
B4: Valet stand conflicts with bikes

B3: Bus bulb/
bike design in
streetscape project

V1: High volumes of
U-Turns mid-block
on U and 14th

P2: Uncontrolled
crossings south of U

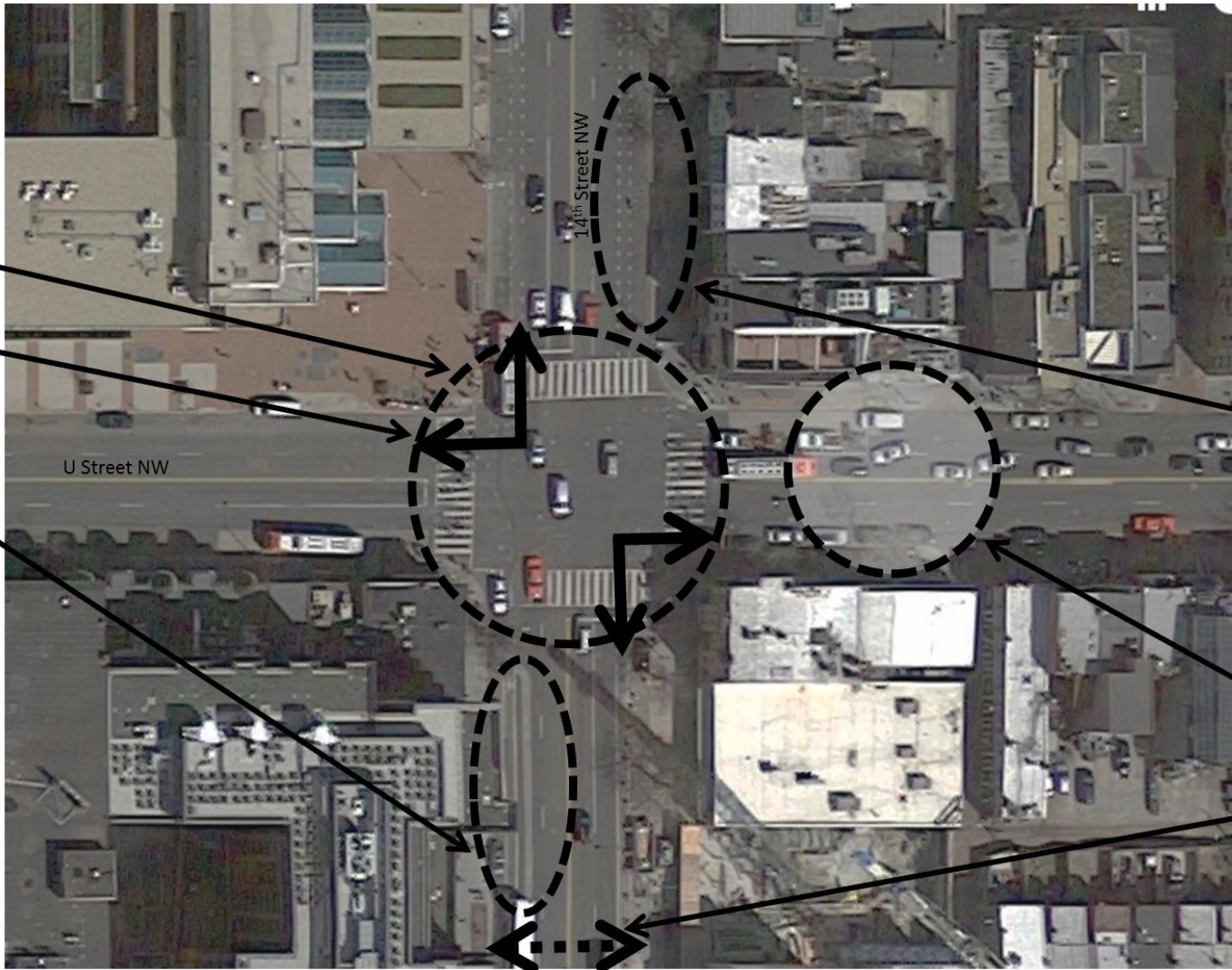

Minnesota Avenue and Benning Road NE

V2: Potential for photoenforcement

V1: Bus turning issues/bunching

P4: Pedestrian crossing issues

P2: Setback of crosswalk creates visibility issues

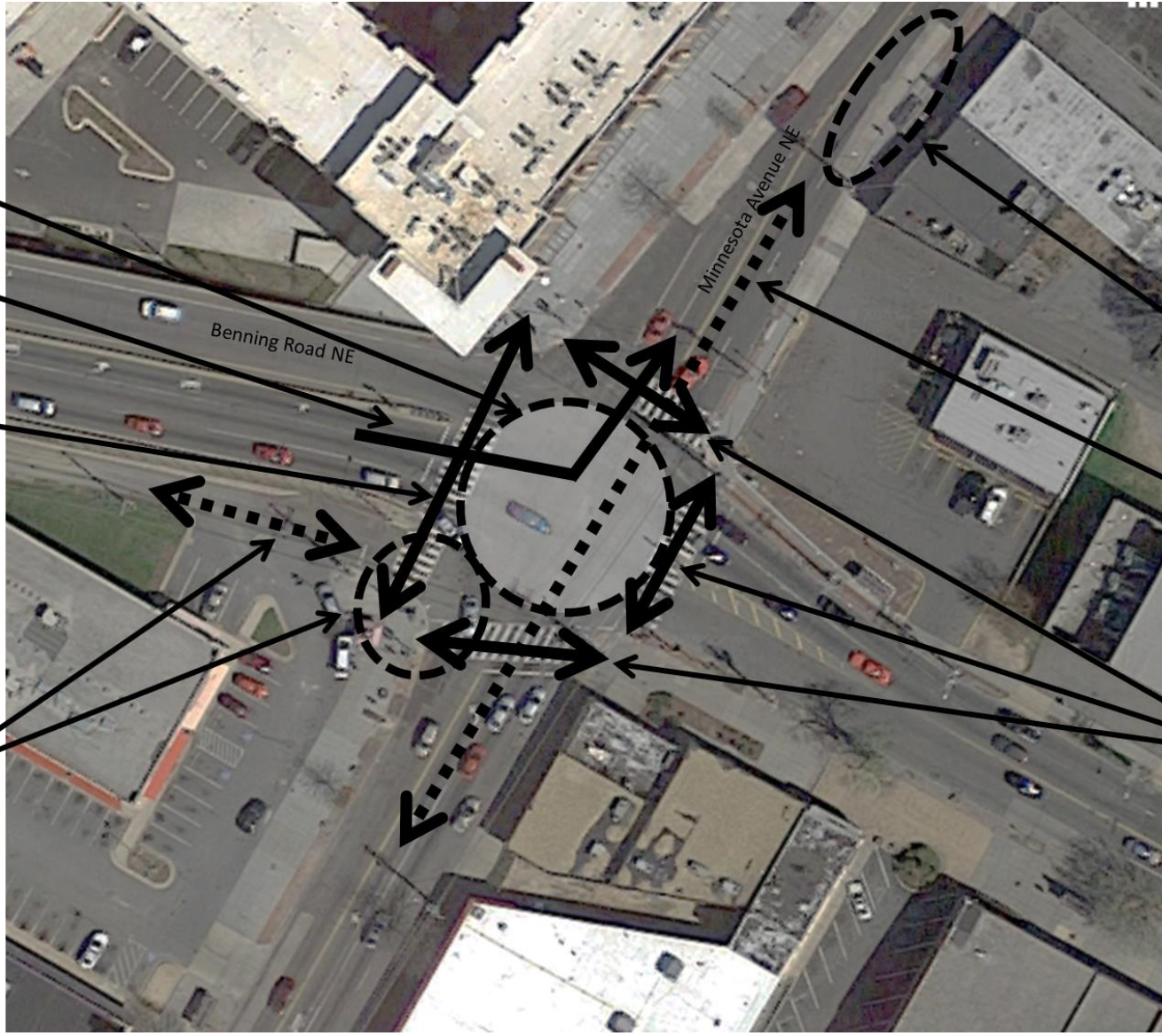

P3: NB bus stop far from Benning Road

B1: No bike connections along Minnesota Ave

P1: Pedestrian crossing issues

M Street and Wisconsin Ave NW

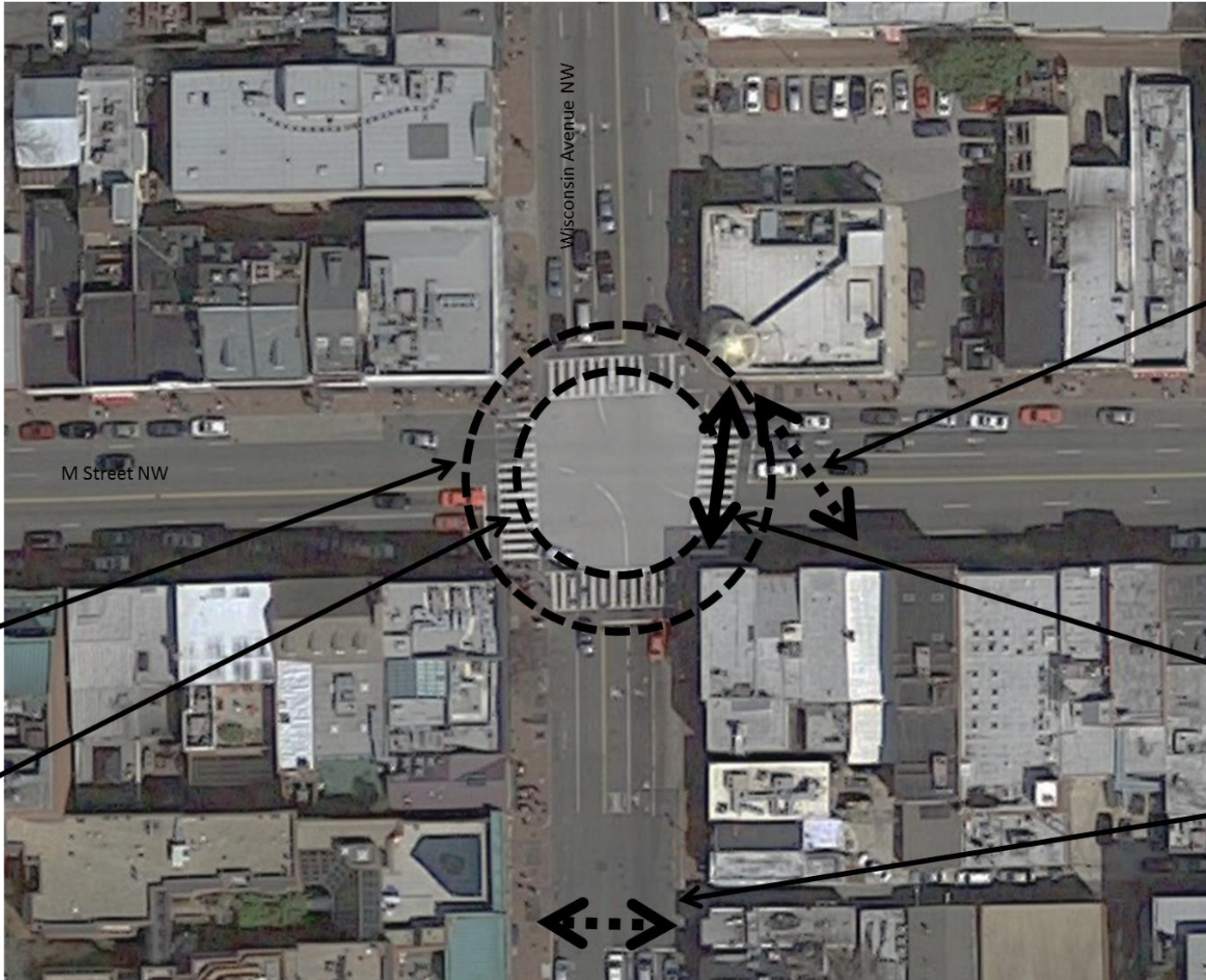

P2: Long crossing distances and small queueing area for pedestrians

V1 and V2: Bad driver behavior and general traffic enforcement

P5: Pedestrians run for buses to access EB stop

P1: Short crossing time for pedestrians across M Street

P3: Frequent pedestrian crossings south of M Street

Compliance Bus Stops Upgraded in FY15

Ward	Quadrant	Work Plan Year	Street Name	From	To	Bus Stop	Actual Start Date	Date Completed	Bus Count
						Number			
1	NW	FY 14	Columbia Rd	Harvard St.	Quarry Rd.	1003225, 1001901, 1001945	5-Jan-2015	10-Feb-2015	3
1	NW	FY 15	16th and Euclid St.			1002874, 1002915	21-Jul-2015	28-Jul-2015	2
2	SW	FY 15	D St.	L'efant Plaza	12th St.	1000659, 1003425	2-Apr-2015	28-Apr-2015	2
2	NW	FY 15	P St.	6th St	7th St.	1001414, 1001431	14-May-2015		2
2	NW	FY 14	23rd St.	N St.	P St.	1001433			1
2	NW	FY 15	3rd St.	Jefferson Dr.	Madison Dr.	New Bus Stop	7-Feb-2015	11-Mar-2015	1
3	NW	FY 15	Connecticut Ave and Military Rd.			1002672, 1002331	29-Jun-2015	10-Jul-2015	2
3	NW	FY 15	Connecticut Ave and Legation St			1002694	1-Jul-2015	14-Jul-2015	1
4	NW	FY 14	16th and Somerset			1002924	21-Mar-2015	1-Apr-2015	1
4	NW	FY 15	Blair Rd.	Peabody St.	Nicholson St.	1002703, 1002699, 1002684, 1002673, 1002662	1-May-2015	12-Jun-2015	5
5	NE	FY 14	Florida Ave.	Staple St.	Holbrook St.	1003269, 1003268	5-Jan-2015	23-Mar-2015	2
5	NE	FY 14	Rhode Island Ave. and 10th			1002964			1
6	SE	FY 14	18th Street and Massachusetts Ave.			1000671, 1000674, 1000676	24-Mar-2015	1-Apr-2015	3
6	NE	FY 15	E Street and Columbus Circle (includes Massachusetts Ave. at Union Station)			New Stop, 1003744	7-Feb-2015	12-Mar-2015	2
7	SE	FY 14	Southern Ave.	Urn St.	Shell Pl.	3000873, 1003798	18-Mar-2015	29-Apr-2015	2
8	SE	FY 16	2ND ST & OAKWOOD St			1000198			1
8	SE	FY 15	Martin L. King Ave	Eaton Rd.	Pomeroy Rd.	1003014, 1000271	2-Jun-2015	18-Jun-2015	2
8	SE	FY 14	Good Hope Rd	15th St	18th St	1000414, 1000410, 1003672, 1000417, 1000416	7-May-2015	1-Jun-2015	5
8	SE	FY 15	MLK and Malcolm X Ave.			1000161, 1000171	22-Jun-2015	9-Jul-2015	2
8	SE	FY 14	Alabama Ave and 24th			1000228	19-Jun-2015	2-Jul-2015	1
8	SE	FY 15	Alabama Ave and 30th			1000336, 1000332	13-Jul-2015	17-Jul-2015	2
8	SE	FY 14	Alabama Ave and Ainger Pl			1000264, 1003034	6-Jul-2015	11-Jul-2015	2
8	SE	FY 16	L'Enfant Sq.	Penn Ave.	Minnesota Ave.	1000483, 1003289, 1000485	30-Nov-2015	30-Jan-2016	3
8	SE	FY 16	Southern Ave.	So. Capital St.	Naylor Rd.	3002821, 3000467, 1003676, 1003801, 1003804, 3000467, 3000497, 3000525, 3000562	13-Oct-2015	Present	9
		FY15	Military Rd NW, WB between Oregon St & 27th St			1002689		6/10/2015	1
		FY15	Constitution Ave NW, Westbound and 7th St NW, Northeast corner			1000867		8/18/2015	1
		FY15	Nebraska Ave and Chesapeake St. NW NB			NA		9/18/2015	1
		FY15	Right side of Connecticut Ave. S B, Beside Block 3100			1002080		10/9/2015	1
		FY15	23 St SB and I St			1003183		10/23/2015	1
			2800 Blk of Bruce Place SE -- 1000267			1000267			1
			5800 Blk Dix St NE -- 1003298			1003298			1
			2600 Blk Franklin St NE -- 1001912			1001912			1

Compliance Bus Stops Upgraded in FY15

Ward	Quadrant	Work Plan Year	Street Name	From	To	Bus Stop	Actual Start Date	Date Completed	Bus Count
						Number			
			UTAH AVE. NW			10028016		2/7/2015	1
			WESTERN AVE. NW/LIVINGSTON ST.			1002705		3/23/2015	1
			5640 WESTERN AVE. NW			1002709		4/6/2015	1
			NEW JERSEY AVE. NW			1001541		5/7/2015	1
			AT 2213 RHODE ISLAND AVE. NE			N/A		5/9/2015	1
			AT 205T NE & RHODE ISLAND AVE. NE			N/A		5/9/2015	1
			AT 13TH ST., NE AND RI AVE. NE			N/A		5/16/2015	1
			AT 2008 RHODE ISLAND AVE., NE			N/A		5/30/2015	1
			AT 24TH ST./S. DAKOTA/RI. AVE. NE			N/A		5/30/2015	1
			2004 Rhode Island Ave., NE			1002030		6/12/2015	1
			5131 5th Street NW			N/A		7/16/2015	1
			14TH St., NE, btwn Constitution/A St. NE			1000841		8/13/2015	1
			Minnesota Ave., SE, btwn C St., & B St., SE			1000718		8/15/2015	1
			Western Ave., NW,			2000013		8/21/2015	1
			Minnesota Ave., SE, btwn C St., & B St., SE			1000698		8/22/2015	1
			Western Ave., NW,			1003124		8/28/2015	1
			14TH ST., NW			1002713		9/9/2015	1
			I ST., SE, btwn 8th St., and 9th st.			N/A		9/19/2015	1
			14TH ST. NW AND SHERIDAN ST., NW			N/A		9/22/2015	1
			14TH ST., NW			1002768		10/7/2015	1
			14TH ST., NW			1002715		10/12/2015	1
			16TH ST. NW			N/A		11/4/2015	1
			5800 14TH ST., NW (OUTBOUND)			N/A		11/24/2015	1
			TEXAS AVE. SE AND CHAPLIN RD. SE			NO ID		12/5/2015	1
			4408 TEXAS AVE., SE			N/A		12/15/2015	1
								Total Bus Stops	90

DC STREETCAR PROGRAM												
Streetcar Program - Current Sources		PROJECT #	7 - year total	Available Balance	FY 2017	FY 2018	FY 2019	FY 2020	FY 2021	FY 2022	FY 2023	FY 2024
	STREETCAR	SA306C	340,346,678	440,996	18,500,000	13,900,000	27,316,744	138,488,499	141,700,439			
	BENNING ROAD BRIDGES	CD052A	20,133,462	133,462			20,000,000					
	K STREET BRIDGES	MRR56A	22,000,000	-	2,000,000	20,000,000					-	
	K STREET TRANSITWAY	SR028A	66,375,000	-				31,500,000	34,875,000		-	
Streetcar Program - Scheduled Uses			Estimated Costs (FY 2015 \$)	FY 2016	FY 2017	FY 2018	FY 2019	FY 2020	FY 2021	FY 2022	FY 2023	FY 2024
PROGRAM WIDE				-	-	-	-	-	-	-	-	-
DDOT LABOR & PROJECT MANAGEMENT COSTS			5,600,000/yr									
H STREET/BENNING			-	-	-	-	-	-	-	-	-	-
BENNING EXTENSION			189,889,948	-	-	-	-	-	-	-	-	-
PRELIMINARY ENGINEERING			19,835,358									
DESIGN			10,392,196									
CONSTRUCTION			136,462,394									
VEHICLES / STARTUP			23,200,000									
UNION STATION TO GEORGETOWN			427,740,000	-	-	-	-	-	-	-	-	-
PRELIMINARY ENGINEERING			4,690,000									
DESIGN			60,057,000									
CONSTRUCTION			280,880,000									
VEHICLES / START UP			82,113,000									

NOTE: H Street Bridge (BR005C & CD054A) are related projects; however they were not included in this spend plan